

Attachment "A"— Wireless Communication Site Lease Agreement

**COUNTY OF MONTEREY
WIRELESS COMMUNICATION
SITE LEASE AGREEMENT**

THIS LEASE AGREEMENT (hereinafter "Agreement") is made and entered into by and between the County of Monterey, a political subdivision of the State of California, (hereinafter "LESSOR"), c/o Real Property Specialist, 855 East Laurel Drive, Building C, Salinas CA 93905, and MetroPCS California/Florida Inc., a Delaware corporation, d/b/a MetroPCS (hereinafter "LESSEE"), with its principal office at 8144 Walnut Hill Lane, Suite 800, Dallas, Texas 75231.

LESSOR and LESSEE hereby agree as follows:

1. PREMISES: LESSOR is the owner of that certain real property located at 1590 Moffett Street, Salinas, California, as more particularly described in Exhibit "A" attached hereto and made a part hereof (the entirety of LESSOR's property is referred to hereinafter as the "Property"). LESSOR hereby leases to LESSEE a portion of said Property consisting of approximately One Hundred Fifty-Eight (158) square feet adjacent to the tower located on the Property for LESSEE's equipment (the "Equipment Space") along with space on the tower for LESSEE's antennas (the "Antenna Space"), as shown in Exhibit "B" attached hereto and made a part hereof. Subject to the requirements as set forth in Section 6 below, LESSEE shall have the non-exclusive right for ingress and egress, seven (7) days a week, twenty-four (24) hours a day, for the purpose of installation and maintenance of the demised premises, which Equipment Space, Antenna Space, and all connections and access are collectively referred to hereinafter as the "Premises".

LESSOR also grants to the LESSEE the right and sufficient space for the installation and maintenance of wires, cables, conduits and pipes generally as shown in Exhibit "B" running from the Equipment Space to the Antenna Space and to install, maintain, replace and repair wires, cables, conduits and pipes from the Premises to the nearest appropriate utilities provider if LESSOR is not providing adequate power and telephone access in the Premises.

2. PERMITTED USE: Subject to the terms of this Agreement, LESSEE shall be permitted to operate and maintain certain wireless communication base station equipment and antennae and other appurtenant and incidental equipment including but not limited to an emergency generator of the type and kind determined solely by LESSEE (hereinafter "Equipment") in the designated area(s) of the Premises, as depicted on Exhibit "B" attached hereto. Any Equipment which has been installed in violation of the terms of this Agreement, or in violation of any approvals granted hereunder, shall be removed by LESSEE forthwith, at LESSOR's reasonable discretion, and at LESSEE's sole cost and expense. All Equipment to be installed under this Agreement shall be clearly marked by LESSEE with its identifying information which shall include the identity and phone number of LESSEE's emergency contact, FCC registration number, and the transmitting and receiving frequencies of the Equipment.

3. IMPROVEMENTS ON THE PREMISES: LESSEE accepts the Premises in an "as is" condition. LESSEE shall have the right to finance and construct approved equipment and related improvements on the Premises at LESSEE's sole cost and expense. LESSOR hereby consents to and approves of LESSEE's initial installation at the Premises, as depicted on Exhibit "B" attached hereto. Following the construction and installation of LESSEE's Equipment, LESSEE may thereafter, at its sole cost and expense, perform construction, maintenance, repairs, additions to, and replacement of its Equipment as necessary and appropriate for its ongoing business and has the right to do all work

Initials LJ _____

Attachment "A"— Wireless Communication Site Lease Agreement

necessary to prepare, modify and maintain the Premises to accommodate LESSEE's Equipment and as required for LESSEE's communications operations at the Premises, including any structural upgrades required to accommodate LESSEE's equipment on the Premises. Notwithstanding the foregoing, once the initial Equipment is installed, LESSEE shall not make any material alterations thereto (or to the Premises structure itself) without obtaining the prior written approval of LESSOR (provided, however, it is understood and agreed that LESSEE shall have the right to make repairs and replacements of "like-kind" equipment without having to obtain LESSOR's consent). LESSEE agrees to submit to the LESSOR, for review and approval, all plans including specifications, working drawings, and other information reasonably required by the LESSOR covering proposed alterations by LESSEE. Said plans shall be submitted to the LESSOR for LESSOR's written approval, which approval shall not be unreasonably withheld, conditioned or delayed. In the event the LESSOR does not either (i) object to the plans in writing or (ii) furnish the LESSEE with written approval, within fifteen (15) days of the date of submission of the plans, LESSOR will be deemed to have approved them. All work to be done by LESSEE shall be performed in accordance with the approved plans unless otherwise approved in writing by the LESSOR which approval shall not be unreasonably withheld, conditioned or delayed.

LESSOR retains the right to make any improvements to the Premises and Property as reasonably deemed necessary by the LESSOR. Said improvements shall not be inconsistent with the LESSEE's use of the Premises. Nothing contained in this Agreement shall be deemed or construed in any way to limit the LESSOR's authority to exercise any right or power concerning the utilization of the Premises and Property. LESSEE's use of the Premises shall be subordinate to the LESSOR's use of the Property. LESSOR shall notify LESSEE of any intended use of the Property by the LESSOR which may be reasonably expected to affect LESSEE's use of the Premises and any such use shall not be inconsistent with nor interfere with LESSEE's use of the Premises.

4. GOVERNMENTAL APPROVALS/TERMINATION: It is understood and agreed that LESSEE's ability to use the Premises is contingent upon its obtaining after the execution date of this Agreement all of the certificates, permits and other approvals relating to the presence and operation of the Equipment at the Premises (collectively the "Governmental Approvals") that may be required by any Federal, State or Local authorities, including all applicable Federal Communications Commission (FCC) requirements. This requirement includes any necessary construction, building or use permits and compliance with any progress inspections that may be required by any regulatory body. In lieu of construction permits, LESSOR may charge LESSEE a reasonable fee for the Facilities Impact Review that will permit LESSEE use of the Premises as set forth above. LESSOR shall cooperate with LESSEE in its effort to obtain such approvals and shall take no action that would adversely affect the status of the Property with respect to the proposed use by LESSEE. In the event that any of such applications for such Governmental Approvals should be finally rejected or any Governmental Approval issued to LESSEE is canceled, expires, lapses, or is otherwise withdrawn or terminated by governmental authority so that LESSEE in its sole discretion will be unable to use the Premises for its intended purposes or the LESSEE determines that the Premises are no longer technically compatible for its intended use, LESSEE shall have the right to terminate this Agreement. Notice of the LESSEE's exercise of its right to terminate shall be given to LESSOR in writing by certified mail, return receipt requested, and shall be effective upon the mailing of such notice by the LESSEE. All Lease Fees paid prior to said termination date shall be retained by the LESSOR. Upon such termination, this Agreement shall be of no further force or effect except to the extent of the representations, warranties and indemnities made by each party to the other hereunder. Otherwise, all the parties shall have no further obligations, including the payment of money, to each other.

5. INTERFERENCE: LESSEE agrees to have installed radio/wireless equipment of the type and frequency that will not cause interference to LESSOR or to other current lessees of the Property. In the event LESSEE's Equipment causes such interference, and after LESSOR has notified LESSEE of such

Initials L _____

Attachment "A"— Wireless Communication Site Lease Agreement

interference pursuant to this Agreement, LESSEE will take all steps necessary to correct and eliminate the interference within thirty (30) days of said notice. LESSOR acknowledges that interference may come from different sources, and LESSEE shall only be responsible to correct interference caused by LESSEE's Equipment. LESSOR agrees that LESSOR and/or any other tenants of the Property who currently have or in the future take possession of the Property will be permitted to install only such radio/wireless equipment that is of the type and frequency which will not cause measurable interference to the existing equipment of the LESSEE.

6. **ACCESS:** LESSOR shall make all reasonable effort to allow LESSEE (including LESSEE's employees, agents, contractors, and subcontractors) twenty-four (24) hour per day/seven (7) days per week access to the Property under the following conditions:

- a) LESSEE shall adhere to LESSOR's security policies (that may be reasonably changed from time to time) regarding access to and use of the Premises.
- b) LESSEE shall contact the LESSOR or designated representative indicated in Section 15, at least one (1) business day (24 hours) in advance, for access onto the Premises, except in the case of an emergency. For emergency access, LESSEE shall contact the Monterey County Communications Dispatch at (831) 755-5100 and ask for the General Services' "emergency on call" person for assistance.
- c) If deemed necessary by LESSOR due to security reasons, LESSEE shall provide identification (business card with driver's license) to the LESSOR or designated representative for each entry onto the Premises.
- d) LESSEE shall park service vehicles on the Property only in places approved by the LESSOR or designated representative.
- e) Subject to Section 5 above, LESSEE shall not unreasonably interfere with LESSOR's operations and employees within the Property and shall not go into any offices, rooms, stairwells, or other portions of the Property not required for the purposes of this Agreement.
- f) LESSEE shall maintain and enforce safety and physical security procedures with respect to its access of LESSOR's facilities: (a) that are at least equivalent to those in effect for LESSOR's employees, officers, contractors, and agents, (b) that are at least equal to industry standards for such types of locations, (c) which provide reasonably appropriate technical and organizational safeguards against accidental or unlawful destruction, loss, alteration, or interruption of LESSOR's communications equipment, facilities, systems, and capabilities, and (d) which prevent unauthorized access, use, or disclosure of LESSOR's confidential information stored at, or communicated via, LESSOR's systems, facilities, and equipment.
- g) LESSEE shall take all reasonable measures to safeguard LESSOR's communications systems, facilities, and equipment from those who may seek to access LESSOR's systems via the facility access granted to LESSEE and periodically test those safeguard measures for potential areas where security could be breached and unauthorized access afforded. LESSEE will provide reports of such security assessments to LESSOR and use diligent efforts to remedy any deficiencies in LESSEE's safety and physical security procedures to avoid a breach of security or unauthorized access to LESSOR's facilities and/or systems.
- h) LESSEE shall immediately report to LESSOR any breach of security or unauthorized facility access that LESSEE observes, detects, or becomes aware of, conduct a root cause analysis to determine if LESSEE's practices contributed to the breach in a timely manner and report any necessary mitigation efforts necessary to avoid future incidents of security breach or unauthorized access.

7. **UTILITIES:** It is the LESSEE's responsibility to provide any electrical power or any other utilities or services for LESSEE's use or benefit at the Premises, and LESSOR shall not be responsible in any way for any loss of power or other utilities which may occur at the Premises except to the extent caused by LESSOR's negligence or willful misconduct. In the event it is necessary for LESSEE to sub-

Initials L _____

Attachment "A"— Wireless Communication Site Lease Agreement

meter from LESSOR, LESSEE shall reimburse LESSOR for any power it uses no later than thirty (30) days from receipt of written notice from LESSOR. LESSOR shall at all times provide electrical service and telephone service access within the Premises. LESSEE, at LESSEE's sole cost and expense, shall be permitted to install, maintain and/or gain access to and use of, as necessary (during any power interruptions at the Premises), a temporary power source with appropriate sound suppression if LESSOR's auxiliary power source is deemed inadequate by a qualified electrical engineer.

8. LEASE FEE AND OTHER CHARGES:

- a) For the rights granted under this Agreement, LESSEE shall pay to LESSOR an annual fee (hereinafter "Lease Fee") in the amount of Eighteen Thousand Dollars and 00/100 (\$18,000.00) per year. LESSEE shall pay the first yearly Lease Fee on the Commencement Date, as defined in Section 9 below. The Lease Fee shall be made to (need not be sent certified): **County of Monterey**, at the address listed below:

County of Monterey
C/o General Services Department, Fiscal Division
855 East Laurel Drive, Building C
Salinas, California 93905

- b) The Lease Fee for all subsequent years during the stated term of this Agreement shall be paid in full by LESSEE to LESSOR, without demand, in advance, and in accordance with subsection a) of this Section.
- c) Upon submittal of the LESSOR's Wireless Communication Site Application Form and Authorization and Indemnification Agreement, LESSEE shall pay LESSOR the non-refundable sum of One Thousand Five Hundred Dollars and 00/100 (\$1,500.00) for collocation engineering review and facilitation.
- d) Upon full execution of this Agreement, LESSEE shall pay LESSOR the non-refundable sum of One Thousand Five Hundred Dollars and 00/100 (\$1,500.00) for lease review and facilitation.

9. **TERM OF AGREEMENT:** The initial term of this Agreement shall be for five (5) years commencing on the first (1st) day of the month following the date this Agreement is executed by the parties or the first (1st) day of the month following the date LESSEE is granted a building permit by the governmental agency charged with issuing such permits, whichever event occurs last (the "Commencement Date").

10. **EXTENSIONS:** This Agreement shall automatically be extended for three (3) additional five (5) year terms unless the LESSEE terminates it at the end of the then current term by giving the LESSOR written notice of the intent to terminate not less than six (6) months prior to the end of the then current term.

11. **LEASE FEE INCREASES:** The Lease Fee shall be increased on each annual anniversary of the Commencement Date by an amount equal to three percent (3%) of the monthly Lease Fee paid for the previous year.

12. **ADDITIONAL EXTENSIONS:** If at the end of the third (3rd) five (5) year extension term this Agreement has not been terminated by either party by giving to the other written notice of an intention to terminate at least three (3) months prior to the end of such term, this Agreement shall continue in force upon the same covenants, terms and conditions for a further term of five (5) years and for five (5) year terms thereafter until terminated by either party by giving to the other written notice of its intention to terminate at least three (3) months prior to the end of such term or until the end of the eighteenth

Initials g _____

Attachment "A"— Wireless Communication Site Lease Agreement

additional five (5) year term, whichever comes first, but in no case exceeding a total of ninety-nine (99) years.

13. ASSIGNMENT: Neither this Agreement nor any rights thereunder shall be transferred or assigned by the LESSEE, nor shall the LESSEE lease to any person or corporation or business entity, or permit the use of any portion of the Premises by others without the written consent of LESSOR, which consent shall not be unreasonably withheld, conditioned or delayed. It is understood and agreed that should LESSOR give consent to a sublease, LESSEE shall pay LESSOR in addition to the Lease Fee fifty percent (50%) of the income actually received from each sublessee. Notwithstanding the above, LESSEE may assign this Agreement, without written consent by LESSOR, to LESSEE's principal, affiliates, subsidiaries of its principal or to any entity which acquires all or substantially all of LESSEE's assets in the market defined by the Federal Communications Commission in which the Property is located by reason of a merger, acquisition, or other business reorganization. Notwithstanding anything to the contrary contained in this Agreement, LESSEE may assign, mortgage, pledge, hypothecate or otherwise transfer with the written consent of LESSOR its interest in this Agreement to any financing entity, or agent on behalf of any financing entity, to whom LESSEE (i) has obligations for borrowed money or in respect of guaranties thereof, (ii) has obligations evidenced by bonds, debentures, notes or similar instruments, or (iii) has obligations under or with respect to letters of credit, bankers acceptances and similar facilities or in respect of guaranties thereof. It is understood and agreed that the written consent of the LESSOR shall not be granted until LESSOR receives satisfactory documentation evidencing LESSEE's Assignee's assumption of the terms and conditions of this Agreement. LESSEE shall not encumber the Premises or Property in any manner whatsoever.

14. ANNUAL TERMINATION: Notwithstanding anything to the contrary contained herein, provided LESSEE is not in default hereunder and shall have paid all of the rents and sums due and payable to the LESSOR by LESSEE, LESSEE shall have the right to terminate this Agreement upon the annual anniversary of this Agreement provided that six (6) months prior notice is given to the LESSOR.

15. NOTICES: Any demand or notice which either party shall be required, or may desire, to make upon or give to the other shall be in writing and shall be delivered personally upon the other or be sent by prepaid certified mail and shall be effective as of the date sent to the respective parties as follows:

To LESSOR: County of Monterey
General Services Department
c/o Real Property Specialist
855 E. Laurel Drive, Building C
Salinas, CA 93905
Tel: (831) 755-4855
Fax: (831) 755-4688
Email: salcidog@co.monterey.ca.us

To LESSEE: MetroPCS California/Florida, Inc.
8144 Walnut Hill Lane, Suite 800
Dallas, Texas 75231
Attn: Property Management
Tel: (214)_265-2550
Fax: (214)_265-2570

Email:

Initials 4 _____

Attachment "A"— Wireless Communication Site Lease Agreement

Either party may, from time to time, designate any other address for this purpose by written notice to the other party. Either party for general communication may use telephone, email or facsimile.

16. ACKNOWLEDGMENT OF TITLE: It is understood and agreed that LESSEE, by the acceptance of this Agreement and by the use or occupancy of said Premises, has not acquired and shall not acquire hereafter any property rights or interest in or to said Premises (other than the leasehold interest granted herein), and LESSEE may use the Premises only as herein provided. LESSEE shall not have, nor will it obtain, any right or claim to the continued use of said Premises beyond that specifically given in this Agreement. LESSOR covenants that LESSEE, on paying the Lease Fee and performing the covenants, shall peaceably and quietly have, hold and enjoy the Premises. LESSOR covenants that LESSOR is seized of good and sufficient title and interest to the Property and has full authority to enter into and execute this Agreement. LESSOR further covenants that there are no other liens, judgments or impediments of title on the Property or affecting LESSOR's title to the same and that there are no covenants, easements or restrictions which prevent the use of the Premises by the LESSEE as set forth above.

17. REPAIRS: LESSEE shall be responsible for all maintenance and repairs of LESSEE's Equipment, and LESSEE shall keep its installation, including but not limited to, fencing and screening, in good, neat and clean condition in conformity with the standards of the local governing body regulations. LESSEE shall be responsible for the timely repair of all damage to Premises and Property caused by the negligence or willful misconduct of LESSEE, its employees, agents or business vendors. LESSEE shall maintain the leased portion of the Property's roofing system, if applicable, in a weather tight condition.

18. INSPECTION: The LESSOR shall have the right at all times to enter upon said Premises to inspect the Equipment and determine if said use is to the satisfaction of LESSOR, provided, however, that LESSOR shall not alter, adjust, move, disrupt or otherwise affect the operation of the LESSEE's Equipment. LESSOR shall provide LESSEE at least forty-eight (48) hours notice prior to entry, and LESSEE may have a representative present during the inspection. If LESSOR alters, adjusts, moves, disrupts or otherwise affects the operation of LESSEE's Equipment during the inspection in such a manner to cause damage to LESSEE's Equipment, LESSOR shall be liable for the damage.

19. INSURANCE COVERAGE REQUIREMENTS: Without limiting LESSEE's duty to indemnify, LESSEE shall maintain in effect throughout the term of this Agreement a policy or policies of insurance with the following minimum limits of liability:

- a) Commercial general liability insurance, including but not limited to premises and operations, including coverage for Bodily Injury and Property Damage, Personal Injury, Contractual liability, Broadform Property Damage, Independent Contractors, Products and Completed Operations, with a combined single limit for Bodily Injury and Property Damage of not less than \$1,000,000 per occurrence.
- b) Business automobile liability insurance, covering all motor vehicles, including owned, leased, non-owned, and hired vehicles, used for purposes under this Agreement, with a combined single limit for Bodily Injury and Property Damage of not less than \$1,000,000 per occurrence.
- c) Workers' Compensation Insurance, if LESSEE employs others in the performance of this Agreement, in accordance with California Labor Code section 3700 and with Employer's Liability limits not less than \$1,000,000 each person, \$1,000,000 each accident and \$1,000,000 each disease.
- d) Other Insurance Requirements. All insurance required by this Agreement shall be with a company acceptable to the LESSOR and issued and executed by an admitted insurer authorized to transact Insurance business in the State of California. Unless otherwise specified by this Agreement, all such insurance shall be written on an occurrence basis, or, if

Initials 3 —

Attachment "A"— Wireless Communication Site Lease Agreement

the policy is not written on an occurrence basis, such policy with the coverage required herein shall continue in effect for a period of three years following termination of this Agreement.

Each liability policy shall provide that the LESSOR shall be given notice in writing at least thirty days in advance of any endorsed reduction in coverage or limit, cancellation, or intended non-renewal thereof. Each policy shall provide coverage for LESSEE and additional insureds with respect to claims arising from each subcontractor, if any, performing work under this Agreement, or be accompanied by a certificate of insurance from each subcontractor showing each subcontractor has identical insurance coverage to the above requirements.

Commercial general liability and automobile liability policies shall provide an endorsement naming the County of Monterey, its officers, agents, and employees as Additional Insureds and shall further provide that such insurance is primary insurance to any insurance or self-insurance maintained by the LESSOR and that the insurance of the Additional Insureds shall not be called upon to contribute to a loss covered by the LESSEE's insurance. The required endorsement form for Commercial General Liability Additional Insured is ISO Form CG 20 10 11-85 or CG 20 10 10 01 in tandem with CG 20 37 10 01 (2000). The required endorsement form for Automobile Additional Insured endorsement is ISO Form CA 20 48 02 99.

Prior to the execution of this Agreement by the LESSOR, LESSEE shall file certificates of insurance with LESSOR showing that the LESSEE has in effect the insurance required by this Agreement. The LESSEE shall file a new or amended certificate of insurance within five calendar days after any change is made in any insurance policy which would alter the information on the certificate then on file. Acceptance or approval of insurance shall in no way modify or change the indemnification clause in this Agreement, which shall continue in full force and effect.

LESSEE shall at all times during the term of this Agreement maintain in force the insurance coverage required under this Agreement and shall send, without demand by LESSOR, annual certificates to LESSOR. If the certificate is not received by the expiration date, LESSOR shall notify LESSEE and LESSEE shall have five calendar days to send in the certificate, evidencing no lapse in coverage during the interim. Failure by LESSEE to maintain such insurance is a default of this Agreement which entitles LESSOR, at its sole discretion, to terminate this Agreement immediately.

20. CONDEMNATION: In the event of any condemnation of the Property, LESSEE may terminate this Agreement upon fifteen (15) days written notice to LESSOR if such condemnation may reasonably be expected to disrupt LESSEE's operations at the Premises for more than forty-five (45) days. LESSEE may on its own behalf make a claim in any condemnation proceeding involving the Premises for losses related to the antennas, Equipment, its relocation costs and its damages and losses (but not for the loss of its leasehold interest). Any such notice of termination shall cause this Agreement to expire with the same force and effect as though the date set forth in such notice were the date originally set as the expiration date of this Agreement, and LESSOR and LESSEE shall make an appropriate adjustment, as of such termination date, with respect to payments due to the other under this Agreement.

21. CASUALTY:

- a) In the event of damage by fire or other casualty to the Premises that cannot reasonably be expected to be repaired within forty-five (45) days following same or, if the Property is damaged by fire or other casualty so that such damage may reasonably be expected to disrupt LESSEE's operations at the Premises for more than forty-five (45) days, then LESSEE may at any time following such fire or other casualty, provided LESSOR has not completed the restoration required to permit LESSEE to resume its operation at the Premises, terminate this Agreement upon fifteen (15) days written notice to LESSOR. Any such notice of termination

Initials L _____

Attachment "A"— Wireless Communication Site Lease Agreement

shall cause this Agreement to expire with the same force and effect as though the date set forth in such notice were the date originally set as the expiration date of this Agreement and LESSOR and LESSEE shall make an appropriate adjustment, as of such termination date, with respect to payments due to the other under this Agreement. Notwithstanding the foregoing, the Lease Fee shall abate during the period of repair following such fire or other casualty.

- b) Should any matter or condition beyond the control of LESSOR and LESSEE, such as war, public emergency, calamity, fire, earthquake, flood, or act of God prevent performance of this Agreement by either party, such party shall be relieved of the performance of such obligations during the time period of the event.
- c) LESSEE shall be solely responsible for any damage or loss to LESSEE's Equipment resulting from theft or vandalism or resulting from any other cause, except as caused by LESSOR's acts or omissions.

22. INDEMNIFICATION: LESSEE shall indemnify, defend, and hold harmless LESSOR, its officers, agents, and employees, from and against any and all claims, liabilities, and losses whatsoever (including damages to property and injuries to or death of persons, court costs, and reasonable attorneys' fees) occurring or resulting to any and all persons, firms or corporations furnishing or supplying work, services, materials, or supplies in connection with this Agreement, and from any and all claims, liabilities, and losses occurring or resulting to any person, firm, or corporation for damage, injury, or death arising out of or connected with the use of the Premises under this Agreement, unless such claims, liabilities, or losses arise out of the sole negligence or willful misconduct of the LESSOR. LESSEE's "use of the premises" includes LESSEE's action or inaction and the action or inaction of LESSEE's officers, employees, agents and subcontractors. This indemnification shall survive any termination of this Agreement and shall be in addition to any other rights that LESSOR or LESSEE may have under applicable law.

23. ENVIRONMENTAL: LESSOR warrants and agrees that neither LESSOR nor, to LESSOR's knowledge, any third party has used, generated, stored or disposed of, or permitted the use, generation, storage or disposal of, any Hazardous Material (as defined below) on, under, about or within LESSOR's Property in violation of any law or regulation. LESSOR and LESSEE each agree that they will not use, generate, store or dispose of any Hazardous Material on, under, about or within LESSOR's Property in violation of any law or regulation. LESSOR and LESSEE each agree to defend and indemnify the other and the other's partners, affiliates, officers, agents and employees against any and all losses, liabilities, claims and/or costs (including reasonable attorneys' fees and costs) arising from any breach of any warranty or agreement contained in this paragraph. "Hazardous Material" shall mean any substance, chemical or waste identified as hazardous, toxic or dangerous in any applicable federal, state or local law or regulation (including petroleum and asbestos).

24. CONDITION OF PREMISES UPON TERMINATION: Within ninety (90) days after termination or expiration of this Agreement, LESSEE at its sole cost and expense shall remove all of LESSEE's Equipment from the Premises and, to the extent reasonably requested by LESSOR, restore the Premises as nearly as possible to the condition in which it existed immediately prior to the Commencement Date, including, but not limited to, removing rooftop mounts and tie downs (if applicable), electrical conduits, cabling and switches, whether underground or above-ground, reasonable wear and tear excepted. LESSEE shall keep on file with LESSOR either (i) a letter of credit, or (ii) a performance bond executed by an admitted surety licensed to do business in California, substantially in the respective forms attached to this Agreement as Exhibit "C," either of which shall be in the amount of Twenty-Five Thousand Dollars and 00/100 (\$25,000.00) for the cost of removal of LESSEE's Equipment and restoration of the Premises in the event LESSEE cannot or will not restore the Premises.

Initials L _____

Attachment "A"— Wireless Communication Site Lease Agreement

25. REAL ESTATE TAXES: LESSEE shall pay as additional rent any documented increase in real estate taxes levied against the leased Property which are directly attributable to the improvements constructed by LESSEE. LESSOR shall provide to LESSEE a copy of any notice, assessment or billing relating to real estate taxes for which LESSEE is responsible under this Agreement within sixty (60) days of receipt of the same by LESSOR. LESSEE shall have no obligation to make payment of any real estate taxes until LESSEE has received the notice, assessment or billing relating to such payment as set forth in the preceding sentence. In the event LESSOR fails to provide to LESSEE a copy of any real estate tax notice, assessment or billing within the sixty (60) day period set forth herein, LESSEE shall be relieved of any obligation or responsibility to make payment of real estate taxes referred to in the notice, assessment or billing which was not timely delivered by LESSOR to LESSEE.

LESSEE shall have the right, at its sole option and at its sole cost and expense, to appeal, challenge or seek modification of any real estate tax assessment or billing for which LESSEE is wholly or partly responsible for payment under this Agreement. LESSOR shall reasonably cooperate with LESSEE in filing, prosecuting and perfecting any appeal or challenge to real estate taxes as set forth in the preceding sentence, including but not limited to, executing any consent to appeal or other similar document.

26. ASSIGNMENT FOR BENEFIT OF CREDITORS, INSOLVENCY, OR BANKRUPTCY: Appointment of a receiver to take possession of LESSEE's assets, LESSEE's general assignment for benefit of creditors, or LESSEE's insolvency or taking or suffering action under the Bankruptcy Act is a breach of this Agreement and this Agreement shall terminate.

27. DEFAULT: Notwithstanding any other provision to the contrary contained herein this Agreement, in the event there is a default by the LESSEE with respect to any of the provisions of this Agreement or its obligations under it, including the payment of the Lease Fee, the LESSOR shall give LESSEE written notice of such default. After receipt of such written notice, the LESSEE shall have fifteen (15) days in which to cure any monetary default and thirty (30) days in which to cure any non-monetary default, provided the LESSEE shall have such extended period as may be required beyond the thirty (30) days if the nature of the cure is such that it reasonably requires more than thirty (30) days and the LESSEE commences the cure within the thirty (30) day period and thereafter continuously and diligently pursues the cure to completion. The LESSOR may not maintain any action or effect any remedies for default against the LESSEE unless and until the LESSEE has failed to cure the same within the time periods provided in this paragraph. The laws of the State of California shall govern this Agreement. The duties and obligations of the parties created hereunder are performable in Monterey County, and such county shall be the venue for any action or proceeding that may be brought or arise by reason or connection with this Agreement.

28. RECORDING: LESSOR agrees to execute a Memorandum of this Agreement that LESSEE may record with the appropriate Recording Officer. The date set forth in the Memorandum of Lease is for recording purposes only and bears no reference to commencement of either term or Lease Fee payments.

29. SUBORDINATION AND NON-DISTURBANCE: At LESSOR's option, this Agreement shall be subordinate to any mortgage or other security interest by LESSOR which from time to time may encumber all or part of the Property or right-of-way; provided, however, every such mortgage or other security interest shall recognize the validity of this Agreement in the event of a foreclosure of LESSOR's interest and also LESSEE's right to remain in occupancy of and have access to the Premises as long as LESSEE is not in default of this Agreement. LESSEE shall execute whatever instruments may reasonably be required to evidence this subordination clause. In the event the Property is encumbered by a mortgage or other security interest, the LESSOR immediately after this Agreement is executed, will

Initials *g* _____

Attachment "A"— Wireless Communication Site Lease Agreement

obtain and furnish to LESSEE a non-disturbance agreement for each such mortgage or other security interest in recordable form. In the event the LESSOR defaults in the payment and/or other performance of any mortgage or other security interest encumbering the Property, LESSEE may, at its sole option and without obligation, cure or correct LESSOR's default and upon doing so, LESSEE shall be subrogated to any and all rights, titles, liens and equities of the holders of such mortgage or security interest and the LESSEE shall be entitled to deduct and setoff against all rents that may otherwise become due under this Agreement the sums paid by LESSEE to cure or correct such defaults.

30. DRUG FREE WORKPLACE: LESSEE and LESSEE's employees shall comply with LESSOR's policy of a drug free workplace. Neither LESSEE nor LESSEE's employees shall unlawfully manufacture, distribute, dispense, possess, or use controlled substances, including but not limited to marijuana, heroin, cocaine, methamphetamine, barbiturates or amphetamines, at any of LESSEE's facilities or LESSOR's facilities or worksites. If any employee of LESSEE is found to be under the influence of or in possession of any illegal substance at or on the Premises or Property, and that employee, during the course of their employ with LESSEE, are convicted or plead nolo contendere to a criminal substance abuse statute, LESSEE shall be responsible for notifying the LESSOR within seventy-two (72) hours of becoming aware of said conviction or plea. Violation of this notification provision shall constitute grounds for termination of this Agreement.

31. HOLDING OVER: In the event that LESSEE shall hold over after expiration of the term of this Agreement or any extension or renewal thereof, with the consent, express or implied, of LESSOR, such holding over shall be deemed merely a tenancy from month-to-month on the terms, covenants, and conditions, so far as applicable, and subject to the same exceptions and reservations, as herein contained, until such tenancy is terminated in a manner prescribed by law.

32. CONFIDENTIALITY: As a result of shared access to some common facilities and communications infrastructure it is paramount that the confidentiality of information being transmitted and the security provisions protecting those communications facilities systems be maintained in the strictest confidence and only be released on a need-to-know basis. Therefore, the parties agree to maintain a mutual Non-Disclosure Agreement throughout the term of this lease agreement and to extend beyond any termination of this lease agreement for the period of time established in the mutual Non-Disclosure Agreement (see ATTACHMENT "A" Exhibit D).

33. MISCELLANEOUS:

- a) LESSEE agrees to abide by any future rules and regulations which may be adopted by LESSOR as long as they do not cause material interference with LESSEE's operations at the Premises. Such rules and regulations shall be reasonably developed by LESSOR and shall be promptly provided to LESSEE in a written form.
- b) LESSOR shall not provide security, patrolled or otherwise, for LESSEE's Equipment and improvements at the Premises.
- c) This Agreement constitutes the entire agreement and understanding between the parties, and supersedes all offers, negotiations and other agreements concerning the subject matter contained herein. Any amendments to this Agreement must be in writing and executed by both parties.

34. TITLE TO LESSEE'S FACILITIES: Title to LESSEE's Facilities and any equipment placed on the Premises by LESSEE shall be held by LESSEE. All of LESSEE's Facilities shall remain the property of LESSEE and are not fixtures. LESSEE has the right to remove all of LESSEE's Facilities at its sole expense on or before the expiration or termination of this Agreement. LESSOR acknowledges that LESSEE may enter into financing arrangements including promissory notes and financial and security agreements for the financing of LESSEE's Facilities (the "Collateral") with a third party

Initials L _____

Attachment "A"— Wireless Communication Site Lease Agreement

financing entity and may in the future enter into additional financing arrangements with other financing entities. In connection therewith, LESSOR (i) consents to the installation of the Collateral to the extent that the Collateral is part of the approved LESSEE's Facilities; (ii) disclaims any interest in the Collateral, as fixtures or otherwise; and (iii) agrees that the Collateral shall be exempt from execution, foreclosure, sale, levy, attachment, or distress for any rent due or to become due and that such Collateral may be removed at any time without recourse to legal proceedings.

IN WITNESS WHEREOF, the parties hereto have executed this Agreement on the dates appearing below their respective authorized signatures.

LESSOR: (County of Monterey)

APPROVED AS TO FORM: (County Counsel)

By: 
Title: Purchasing Manager
Date: 10/28/05

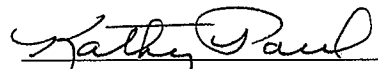
By: 
Title: Deputy County Counsel
Date: October 27, 2005

LESSEE: (MetroPCS - California/Florida, Inc.)

By: 
Title: Vice President/General Manager
Date: 09/28/05

(Location # _____)

Initials h _____

Attachment "A"— Wireless Communication Site Lease Agreement

Exhibit A

(Legal Description of the Property)

Real Property in the City of Salinas, County of Monterey, State of California, described as follows:

LOT 7, AS SHOWN ON THE MAP ENTITLED "TRACT NO. 922, UNIT NO. 1, SALINAS AIRPORT BUSINESS" FILED FOR RECORD MAY 6, 1981 IN VOLUME 14 OF "CITIES AND TOWNS", AT PAGE 57, IN THE OFFICE OF THE COUNTY RECORDER OF MONTEREY COUNTY, CALIFORNIA.

Initials *h* _____

IFB# 9795

Attachment "A"— Wireless Communication Site Lease Agreement

Exhibit B

(Sketch of the Premises)

See insert(s)

Ten (10) Pages Attached (T-1,T-2,A-1,A-2,A-3,A-4,A-5,E-1,E-2,E-3)

Initials *h*

IFB# 9795

BATTERY INFORMATION

ITEM	QUANTITY	UNIT	DESCRIPTION
1	1	CONCRETE	CONCRETE FOR BATTERY
2	1	REINFORCING	REINFORCING FOR BATTERY
3	1	STEEL	STEEL FOR BATTERY
4	1	WALL	WALL FOR BATTERY
5	1	SLAB	SLAB FOR BATTERY
6	1	BEAM	BEAM FOR BATTERY
7	1	WALL	WALL FOR BATTERY
8	1	SLAB	SLAB FOR BATTERY
9	1	BEAM	BEAM FOR BATTERY
10	1	WALL	WALL FOR BATTERY
11	1	SLAB	SLAB FOR BATTERY
12	1	BEAM	BEAM FOR BATTERY
13	1	WALL	WALL FOR BATTERY
14	1	SLAB	SLAB FOR BATTERY
15	1	BEAM	BEAM FOR BATTERY
16	1	WALL	WALL FOR BATTERY
17	1	SLAB	SLAB FOR BATTERY
18	1	BEAM	BEAM FOR BATTERY
19	1	WALL	WALL FOR BATTERY
20	1	SLAB	SLAB FOR BATTERY
21	1	BEAM	BEAM FOR BATTERY
22	1	WALL	WALL FOR BATTERY
23	1	SLAB	SLAB FOR BATTERY
24	1	BEAM	BEAM FOR BATTERY
25	1	WALL	WALL FOR BATTERY
26	1	SLAB	SLAB FOR BATTERY
27	1	BEAM	BEAM FOR BATTERY
28	1	WALL	WALL FOR BATTERY
29	1	SLAB	SLAB FOR BATTERY
30	1	BEAM	BEAM FOR BATTERY
31	1	WALL	WALL FOR BATTERY
32	1	SLAB	SLAB FOR BATTERY
33	1	BEAM	BEAM FOR BATTERY
34	1	WALL	WALL FOR BATTERY
35	1	SLAB	SLAB FOR BATTERY
36	1	BEAM	BEAM FOR BATTERY
37	1	WALL	WALL FOR BATTERY
38	1	SLAB	SLAB FOR BATTERY
39	1	BEAM	BEAM FOR BATTERY
40	1	WALL	WALL FOR BATTERY
41	1	SLAB	SLAB FOR BATTERY
42	1	BEAM	BEAM FOR BATTERY
43	1	WALL	WALL FOR BATTERY
44	1	SLAB	SLAB FOR BATTERY
45	1	BEAM	BEAM FOR BATTERY
46	1	WALL	WALL FOR BATTERY
47	1	SLAB	SLAB FOR BATTERY
48	1	BEAM	BEAM FOR BATTERY
49	1	WALL	WALL FOR BATTERY
50	1	SLAB	SLAB FOR BATTERY
51	1	BEAM	BEAM FOR BATTERY
52	1	WALL	WALL FOR BATTERY
53	1	SLAB	SLAB FOR BATTERY
54	1	BEAM	BEAM FOR BATTERY
55	1	WALL	WALL FOR BATTERY
56	1	SLAB	SLAB FOR BATTERY
57	1	BEAM	BEAM FOR BATTERY
58	1	WALL	WALL FOR BATTERY
59	1	SLAB	SLAB FOR BATTERY
60	1	BEAM	BEAM FOR BATTERY
61	1	WALL	WALL FOR BATTERY
62	1	SLAB	SLAB FOR BATTERY
63	1	BEAM	BEAM FOR BATTERY
64	1	WALL	WALL FOR BATTERY
65	1	SLAB	SLAB FOR BATTERY
66	1	BEAM	BEAM FOR BATTERY
67	1	WALL	WALL FOR BATTERY
68	1	SLAB	SLAB FOR BATTERY
69	1	BEAM	BEAM FOR BATTERY
70	1	WALL	WALL FOR BATTERY
71	1	SLAB	SLAB FOR BATTERY
72	1	BEAM	BEAM FOR BATTERY
73	1	WALL	WALL FOR BATTERY
74	1	SLAB	SLAB FOR BATTERY
75	1	BEAM	BEAM FOR BATTERY
76	1	WALL	WALL FOR BATTERY
77	1	SLAB	SLAB FOR BATTERY
78	1	BEAM	BEAM FOR BATTERY
79	1	WALL	WALL FOR BATTERY
80	1	SLAB	SLAB FOR BATTERY
81	1	BEAM	BEAM FOR BATTERY
82	1	WALL	WALL FOR BATTERY
83	1	SLAB	SLAB FOR BATTERY
84	1	BEAM	BEAM FOR BATTERY
85	1	WALL	WALL FOR BATTERY
86	1	SLAB	SLAB FOR BATTERY
87	1	BEAM	BEAM FOR BATTERY
88	1	WALL	WALL FOR BATTERY
89	1	SLAB	SLAB FOR BATTERY
90	1	BEAM	BEAM FOR BATTERY
91	1	WALL	WALL FOR BATTERY
92	1	SLAB	SLAB FOR BATTERY
93	1	BEAM	BEAM FOR BATTERY
94	1	WALL	WALL FOR BATTERY
95	1	SLAB	SLAB FOR BATTERY
96	1	BEAM	BEAM FOR BATTERY
97	1	WALL	WALL FOR BATTERY
98	1	SLAB	SLAB FOR BATTERY
99	1	BEAM	BEAM FOR BATTERY
100	1	WALL	WALL FOR BATTERY

1. THE ELECTRICIAN AND/OR JUMPERS SHALL BE RESPONSIBLE FOR THE PROTECTION OF THE BATTERY FROM THE LOCAL DRAINAGE SYSTEM.
2. THE ELECTRICIAN SHALL BE RESPONSIBLE FOR THE PROTECTION OF THE BATTERY FROM THE LOCAL DRAINAGE SYSTEM.
3. THE ELECTRICIAN SHALL BE RESPONSIBLE FOR THE PROTECTION OF THE BATTERY FROM THE LOCAL DRAINAGE SYSTEM.
4. THE ELECTRICIAN SHALL BE RESPONSIBLE FOR THE PROTECTION OF THE BATTERY FROM THE LOCAL DRAINAGE SYSTEM.
5. THE ELECTRICIAN SHALL BE RESPONSIBLE FOR THE PROTECTION OF THE BATTERY FROM THE LOCAL DRAINAGE SYSTEM.

ANTENNA & CABLE SCHEDULE

ANTENNA SECTOR	ANTENNA MAKE/MODEL	CABLE LENGTH	NUMBER OF CABLES PER SECTOR	CABLE SIZE	CABLE NO. / PORT NO.	CABLE CODE	TOP JUMPER LENGTH	BOTTOM JUMPER LENGTH	ELECTRICAL DOWNHILL	MECHANICAL DOWNHILL	COMMENTS
SECTOR A (UPN)	DAS R85-18-00912	95'±	2	7/8"	1/100: ALPHA 1/ PORT 1	RED	4'	3'	2	0'	-
SECTOR B (DOWN)	DAS R85-18-00912	95'±	2	7/8"	1/100: BETA 1/ PORT 2	RED	4'	3'	2	0'	-
SECTOR C (DOWN)	DAS R85-18-00912	95'±	2	7/8"	1/100: GAMMA 1/ PORT 3	RED	4'	3'	2	0'	-
GPS	DAS R85-18-00912	10'±	1	1/2"	1/100: DELTA 1/ PORT 4	RED	-	-	-	-	-

NOTE: CONTRACTOR TO FIELD VERIFY CABLE LENGTHS FROM TO ORDERING, FABRICATOR, OR INSTALLATION OF CABLES.

CONCRETE AND REINFORCING STEEL NOTES

1. ALL CONCRETE SHALL BE IN ACCORDANCE WITH THE ACI 308, ACI 318, ACI 309, ACI 314, ACI 315, ACI 316, ACI 317, ACI 318, ACI 319, ACI 320, ACI 321, ACI 322, ACI 323, ACI 324, ACI 325, ACI 326, ACI 327, ACI 328, ACI 329, ACI 330, ACI 331, ACI 332, ACI 333, ACI 334, ACI 335, ACI 336, ACI 337, ACI 338, ACI 339, ACI 340, ACI 341, ACI 342, ACI 343, ACI 344, ACI 345, ACI 346, ACI 347, ACI 348, ACI 349, ACI 350, ACI 351, ACI 352, ACI 353, ACI 354, ACI 355, ACI 356, ACI 357, ACI 358, ACI 359, ACI 360, ACI 361, ACI 362, ACI 363, ACI 364, ACI 365, ACI 366, ACI 367, ACI 368, ACI 369, ACI 370, ACI 371, ACI 372, ACI 373, ACI 374, ACI 375, ACI 376, ACI 377, ACI 378, ACI 379, ACI 380, ACI 381, ACI 382, ACI 383, ACI 384, ACI 385, ACI 386, ACI 387, ACI 388, ACI 389, ACI 390, ACI 391, ACI 392, ACI 393, ACI 394, ACI 395, ACI 396, ACI 397, ACI 398, ACI 399, ACI 400, ACI 401, ACI 402, ACI 403, ACI 404, ACI 405, ACI 406, ACI 407, ACI 408, ACI 409, ACI 410, ACI 411, ACI 412, ACI 413, ACI 414, ACI 415, ACI 416, ACI 417, ACI 418, ACI 419, ACI 420, ACI 421, ACI 422, ACI 423, ACI 424, ACI 425, ACI 426, ACI 427, ACI 428, ACI 429, ACI 430, ACI 431, ACI 432, ACI 433, ACI 434, ACI 435, ACI 436, ACI 437, ACI 438, ACI 439, ACI 440, ACI 441, ACI 442, ACI 443, ACI 444, ACI 445, ACI 446, ACI 447, ACI 448, ACI 449, ACI 450, ACI 451, ACI 452, ACI 453, ACI 454, ACI 455, ACI 456, ACI 457, ACI 458, ACI 459, ACI 460, ACI 461, ACI 462, ACI 463, ACI 464, ACI 465, ACI 466, ACI 467, ACI 468, ACI 469, ACI 470, ACI 471, ACI 472, ACI 473, ACI 474, ACI 475, ACI 476, ACI 477, ACI 478, ACI 479, ACI 480, ACI 481, ACI 482, ACI 483, ACI 484, ACI 485, ACI 486, ACI 487, ACI 488, ACI 489, ACI 490, ACI 491, ACI 492, ACI 493, ACI 494, ACI 495, ACI 496, ACI 497, ACI 498, ACI 499, ACI 500, ACI 501, ACI 502, ACI 503, ACI 504, ACI 505, ACI 506, ACI 507, ACI 508, ACI 509, ACI 510, ACI 511, ACI 512, ACI 513, ACI 514, ACI 515, ACI 516, ACI 517, ACI 518, ACI 519, ACI 520, ACI 521, ACI 522, ACI 523, ACI 524, ACI 525, ACI 526, ACI 527, ACI 528, ACI 529, ACI 530, ACI 531, ACI 532, ACI 533, ACI 534, ACI 535, ACI 536, ACI 537, ACI 538, ACI 539, ACI 540, ACI 541, ACI 542, ACI 543, ACI 544, ACI 545, ACI 546, ACI 547, ACI 548, ACI 549, ACI 550, ACI 551, ACI 552, ACI 553, ACI 554, ACI 555, ACI 556, ACI 557, ACI 558, ACI 559, ACI 560, ACI 561, ACI 562, ACI 563, ACI 564, ACI 565, ACI 566, ACI 567, ACI 568, ACI 569, ACI 570, ACI 571, ACI 572, ACI 573, ACI 574, ACI 575, ACI 576, ACI 577, ACI 578, ACI 579, ACI 580, ACI 581, ACI 582, ACI 583, ACI 584, ACI 585, ACI 586, ACI 587, ACI 588, ACI 589, ACI 590, ACI 591, ACI 592, ACI 593, ACI 594, ACI 595, ACI 596, ACI 597, ACI 598, ACI 599, ACI 600, ACI 601, ACI 602, ACI 603, ACI 604, ACI 605, ACI 606, ACI 607, ACI 608, ACI 609, ACI 610, ACI 611, ACI 612, ACI 613, ACI 614, ACI 615, ACI 616, ACI 617, ACI 618, ACI 619, ACI 620, ACI 621, ACI 622, ACI 623, ACI 624, ACI 625, ACI 626, ACI 627, ACI 628, ACI 629, ACI 630, ACI 631, ACI 632, ACI 633, ACI 634, ACI 635, ACI 636, ACI 637, ACI 638, ACI 639, ACI 640, ACI 641, ACI 642, ACI 643, ACI 644, ACI 645, ACI 646, ACI 647, ACI 648, ACI 649, ACI 650, ACI 651, ACI 652, ACI 653, ACI 654, ACI 655, ACI 656, ACI 657, ACI 658, ACI 659, ACI 660, ACI 661, ACI 662, ACI 663, ACI 664, ACI 665, ACI 666, ACI 667, ACI 668, ACI 669, ACI 670, ACI 671, ACI 672, ACI 673, ACI 674, ACI 675, ACI 676, ACI 677, ACI 678, ACI 679, ACI 680, ACI 681, ACI 682, ACI 683, ACI 684, ACI 685, ACI 686, ACI 687, ACI 688, ACI 689, ACI 690, ACI 691, ACI 692, ACI 693, ACI 694, ACI 695, ACI 696, ACI 697, ACI 698, ACI 699, ACI 700, ACI 701, ACI 702, ACI 703, ACI 704, ACI 705, ACI 706, ACI 707, ACI 708, ACI 709, ACI 710, ACI 711, ACI 712, ACI 713, ACI 714, ACI 715, ACI 716, ACI 717, ACI 718, ACI 719, ACI 720, ACI 721, ACI 722, ACI 723, ACI 724, ACI 725, ACI 726, ACI 727, ACI 728, ACI 729, ACI 730, ACI 731, ACI 732, ACI 733, ACI 734, ACI 735, ACI 736, ACI 737, ACI 738, ACI 739, ACI 740, ACI 741, ACI 742, ACI 743, ACI 744, ACI 745, ACI 746, ACI 747, ACI 748, ACI 749, ACI 750, ACI 751, ACI 752, ACI 753, ACI 754, ACI 755, ACI 756, ACI 757, ACI 758, ACI 759, ACI 760, ACI 761, ACI 762, ACI 763, ACI 764, ACI 765, ACI 766, ACI 767, ACI 768, ACI 769, ACI 770, ACI 771, ACI 772, ACI 773, ACI 774, ACI 775, ACI 776, ACI 777, ACI 778, ACI 779, ACI 780, ACI 781, ACI 782, ACI 783, ACI 784, ACI 785, ACI 786, ACI 787, ACI 788, ACI 789, ACI 790, ACI 791, ACI 792, ACI 793, ACI 794, ACI 795, ACI 796, ACI 797, ACI 798, ACI 799, ACI 800, ACI 801, ACI 802, ACI 803, ACI 804, ACI 805, ACI 806, ACI 807, ACI 808, ACI 809, ACI 810, ACI 811, ACI 812, ACI 813, ACI 814, ACI 815, ACI 816, ACI 817, ACI 818, ACI 819, ACI 820, ACI 821, ACI 822, ACI 823, ACI 824, ACI 825, ACI 826, ACI 827, ACI 828, ACI 829, ACI 830, ACI 831, ACI 832, ACI 833, ACI 834, ACI 835, ACI 836, ACI 837, ACI 838, ACI 839, ACI 840, ACI 841, ACI 842, ACI 843, ACI 844, ACI 845, ACI 846, ACI 847, ACI 848, ACI 849, ACI 850, ACI 851, ACI 852, ACI 853, ACI 854, ACI 855, ACI 856, ACI 857, ACI 858, ACI 859, ACI 860, ACI 861, ACI 862, ACI 863, ACI 864, ACI 865, ACI 866, ACI 867, ACI 868, ACI 869, ACI 870, ACI 871, ACI 872, ACI 873, ACI 874, ACI 875, ACI 876, ACI 877, ACI 878, ACI 879, ACI 880, ACI 881, ACI 882, ACI 883, ACI 884, ACI 885, ACI 886, ACI 887, ACI 888, ACI 889, ACI 890, ACI 891, ACI 892, ACI 893, ACI 894, ACI 895, ACI 896, ACI 897, ACI 898, ACI 899, ACI 900, ACI 901, ACI 902, ACI 903, ACI 904, ACI 905, ACI 906, ACI 907, ACI 908, ACI 909, ACI 910, ACI 911, ACI 912, ACI 913, ACI 914, ACI 915, ACI 916, ACI 917, ACI 918, ACI 919, ACI 920, ACI 921, ACI 922, ACI 923, ACI 924, ACI 925, ACI 926, ACI 927, ACI 928, ACI 929, ACI 930, ACI 931, ACI 932, ACI 933, ACI 934, ACI 935, ACI 936, ACI 937, ACI 938, ACI 939, ACI 940, ACI 941, ACI 942, ACI 943, ACI 944, ACI 945, ACI 946, ACI 947, ACI 948, ACI 949, ACI 950, ACI 951, ACI 952, ACI 953, ACI 954, ACI 955, ACI 956, ACI 957, ACI 958, ACI 959, ACI 960, ACI 961, ACI 962, ACI 963, ACI 964, ACI 965, ACI 966, ACI 967, ACI 968, ACI 969, ACI 970, ACI 971, ACI 972, ACI 973, ACI 974, ACI 975, ACI 976, ACI 977, ACI 978, ACI 979, ACI 980, ACI 981, ACI 982, ACI 983, ACI 984, ACI 985, ACI 986, ACI 987, ACI 988, ACI 989, ACI 990, ACI 991, ACI 992, ACI 993, ACI 994, ACI 995, ACI 996, ACI 997, ACI 998, ACI 999, ACI 1000, ACI 1001, ACI 1002, ACI 1003, ACI 1004, ACI 1005, ACI 1006, ACI 1007, ACI 1008, ACI 1009, ACI 1010, ACI 1011, ACI 1012, ACI 1013, ACI 1014, ACI 1015, ACI 1016, ACI 1017, ACI 1018, ACI 1019, ACI 1020, ACI 1021, ACI 1022, ACI 1023, ACI 1024, ACI 1025, ACI 1026, ACI 1027, ACI 1028, ACI 1029, ACI 1030, ACI 1031, ACI 1032, ACI 1033, ACI 1034, ACI 1035, ACI 1036, ACI 1037, ACI 1038, ACI 1039, ACI 1040, ACI 1041, ACI 1042, ACI 1043, ACI 1044, ACI 1045, ACI 1046, ACI 1047, ACI 1048, ACI 1049, ACI 1050, ACI 1051, ACI 1052, ACI 1053, ACI 1054, ACI 1055, ACI 1056, ACI 1057, ACI 1058, ACI 1059, ACI 1060, ACI 1061, ACI 1062, ACI 1063, ACI 1064, ACI 1065, ACI 1066, ACI 1067, ACI 1068, ACI 1069, ACI 1070, ACI 1071, ACI 1072, ACI 1073, ACI 1074, ACI 1075, ACI 1076, ACI 1077, ACI 1078, ACI 1079, ACI 1080, ACI 1081, ACI 1082, ACI 1083, ACI 1084, ACI 1085, ACI 1086, ACI 1087, ACI 1088, ACI 1089, ACI 1090, ACI 1091, ACI 1092, ACI 1093, ACI 1094, ACI 1095, ACI 1096, ACI 1097, ACI 1098, ACI 1099, ACI 1100, ACI 1101, ACI 1102, ACI 1103, ACI 1104, ACI 1105, ACI 1106, ACI 1107, ACI 1108, ACI 1109, ACI 1110, ACI 1111, ACI 1112, ACI 1113, ACI 1114, ACI 1115, ACI 1116, ACI 1117, ACI 1118, ACI 1119, ACI 1120, ACI 1121, ACI 1122, ACI 1123, ACI 1124, ACI 1125, ACI 1126, ACI 1127, ACI 1128, ACI 1129, ACI 1130, ACI 1131, ACI 1132, ACI 1133, ACI 1134, ACI 1135, ACI 1136, ACI 1137, ACI 1138, ACI 1139, ACI 1140, ACI 1141, ACI 1142, ACI 1143, ACI 1144, ACI 1145, ACI 1146, ACI 1147, ACI 1148, ACI 1149, ACI 1150, ACI 1151, ACI 1152, ACI 1153, ACI 1154, ACI 1155, ACI 1156, ACI 1157, ACI 1158, ACI 1159, ACI 1160, ACI 1161, ACI 1162, ACI 1163, ACI 1164, ACI 1165, ACI 1166, ACI 1167, ACI 1168, ACI 1169, ACI 1170, ACI 1171, ACI 1172, ACI 1173, ACI 1174, ACI 1175, ACI 1176, ACI 1177, ACI 1178, ACI 1179, ACI 1180, ACI 1181, ACI 1182, ACI 1183, ACI 1184, ACI 1185, ACI 1186, ACI 1187, ACI 1188, ACI 1189, ACI 1190, ACI 1191, ACI 1192, ACI 1193, ACI 1194, ACI 1195, ACI 1196, ACI 1197, ACI 1198, ACI 1199, ACI 1200, ACI 1201, ACI 1202, ACI 1203, ACI 1204, ACI 1205, ACI 1206, ACI 1207, ACI 1208, ACI 1209, ACI 1210, ACI 1211, ACI 1212, ACI 1213, ACI 1214, ACI 1215, ACI 1216, ACI 1217, ACI 1218, ACI 1219, ACI 1220, ACI 1221, ACI 1222, ACI 1223, ACI 1224, ACI 1225, ACI 1226, ACI 1227, ACI 1228, ACI 1229, ACI 1230, ACI 1231, ACI 1232, ACI 1233, ACI 1234, ACI 1235, ACI 1236, ACI 1237, ACI 1238, ACI 1239, ACI 1240, ACI 1241, ACI 1242, ACI 1243, ACI 1244, ACI 1245, ACI 1246, ACI 1247, ACI 1248, ACI 1249, ACI 1250, ACI 1251, ACI 1252, ACI 1253, ACI 1254, ACI 1255, ACI 1256, ACI 1257, ACI 1258, ACI 1259, ACI 1260, ACI 1261, ACI

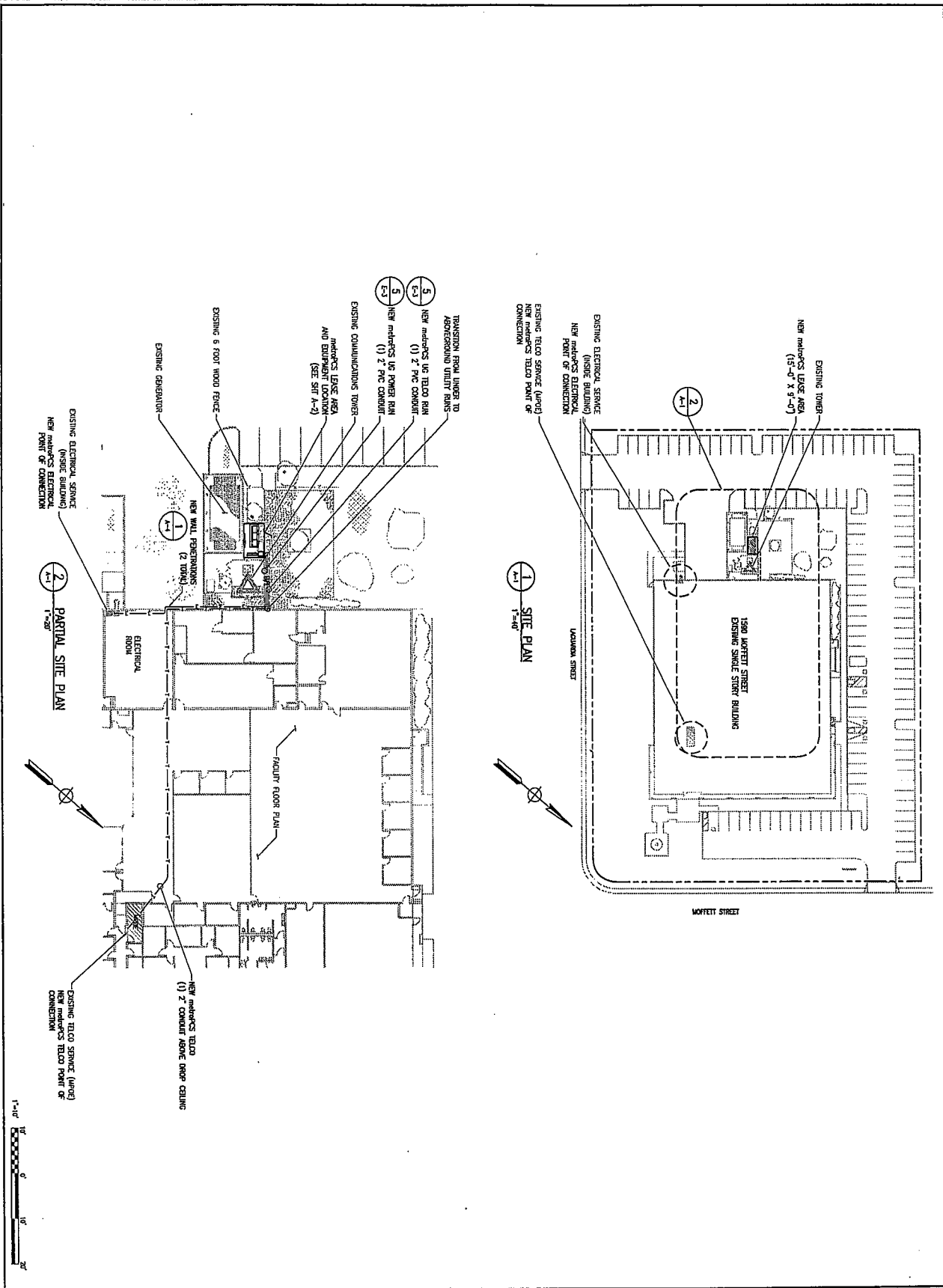

1 SITE PLAN
 1/4" = 1'-0"

2 PARTIAL SITE PLAN
 1/4" = 1'-0"



SHEET TITLE
 OVERALL SITE PLAN
 PARTIAL SITE PLAN
 SHEET

SITE NAME
 COUNTY OF MONTEREY
 LTD COMM. TOWER
 SITE NUMBER
 SF-167600A

SITE ADDRESS
 1590 MOFFETT STREET
 SALINAS, CA 93905

DESIGN BY: PJS
 CHECKED BY: AZB
 JOB NUMBER: 0513

THIS DRAWING IS CONSIDERED VALID & THE SOLE PROPERTY OF THE OWNER. IT IS PROVIDED AS A SERVICE TO THE CLIENT AND IS NOT TO BE REPRODUCED OR TRANSMITTED IN ANY FORM OR BY ANY MEANS, WITHOUT THE WRITTEN PERMISSION OF THE OWNER.

ISSUED NO.	DATE	DESCRIPTION
C	10/21/05	100% CONSTRUCTION
B	10/21/05	90% CONSTRUCTION
A	10/20/05	90% ZONING REVIEW

REVISIONS	NO.	DATE	DESCRIPTION
Δ	1		
Δ	2		
Δ	3		
Δ	4		
Δ	5		
Δ	6		
Δ	7		
Δ	8		
Δ	9		
Δ	10		



metropcs
 Benjamin & Associates, Inc.
 P.O. Box 16423
 San Francisco, California 94116
 PH 415-421-4276
 FAX 415-421-4276
 WWW.METROP.CS

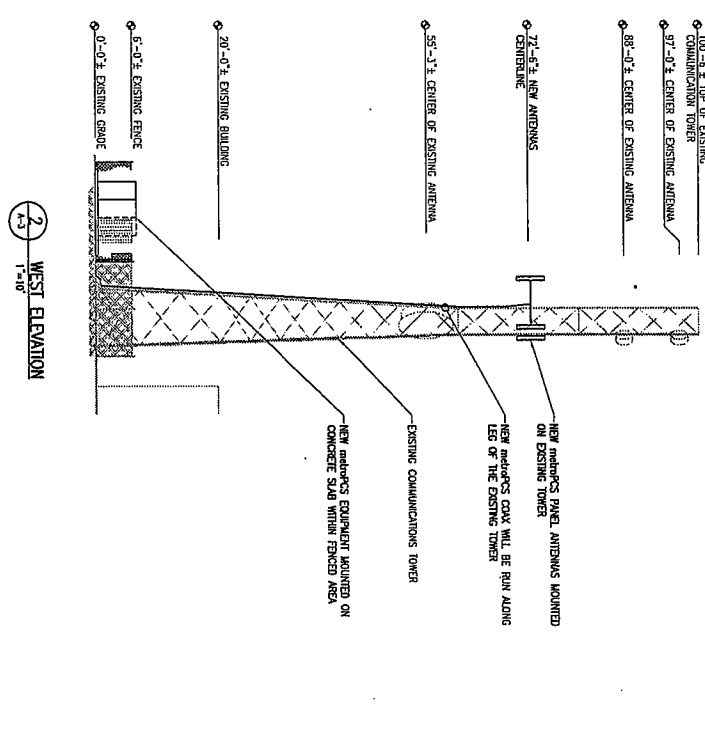
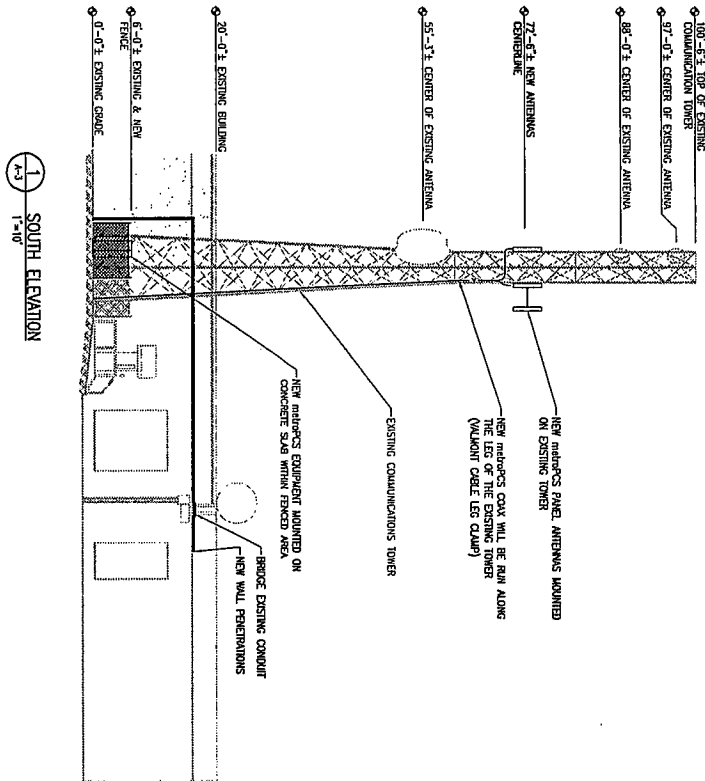
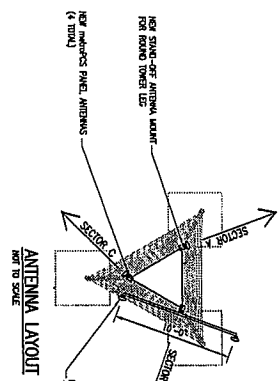
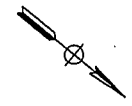
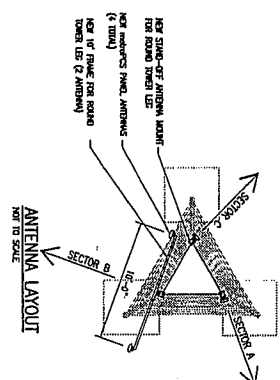

metropcs

Benjamin & Associates, Inc.
 P.O. Box 18423
 San Francisco, California 94116
 Fax 831-400-3100
 www.bap-inc.com

REVISIONS

NO.	DATE	DESCRIPTION
A	03/05/03	100% CONSTRUCTION
B	03/14/03	80% CONSTRUCTION
C	03/17/03	100% CONSTRUCTION

DESIGNED BY: PJS
 CHECKED BY: AZB
 JOB NUMBER: 0513

SITE NAME: COUNTY OF MONTEREY
 ITD COMM. TOWER
 SITE NUMBER: SF16760A
 SITE ADDRESS: 1590 MOFFETT STREET
 SALINAS, CA 93905

SHEET TITLE: ELEVATIONS

SHEET NUMBER: A-3

<p>NOT USED</p> <p>SCALE: NONE NAME: NONE</p>	<p>PANEL ANTENNA MOUNT</p> <p>SCALE: NONE NAME: NONE</p>	<p>GPS ANTENNA MOUNT</p> <p>SCALE: NONE NAME: NONE</p>	<p>UTILITY RACK</p> <p>SCALE: NONE NAME: NONE</p>
---	--	--	---

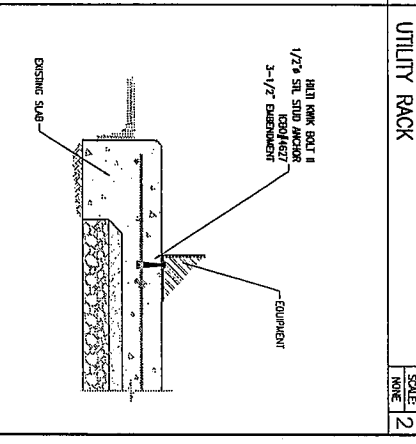
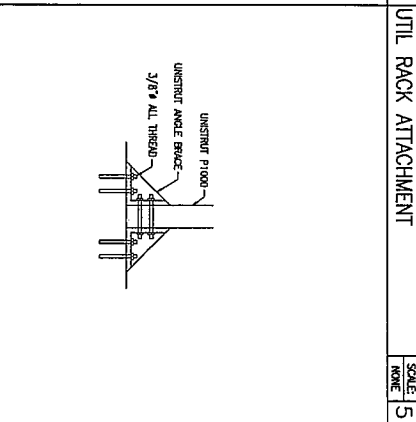
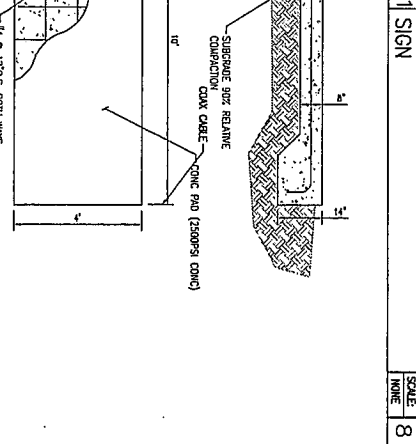
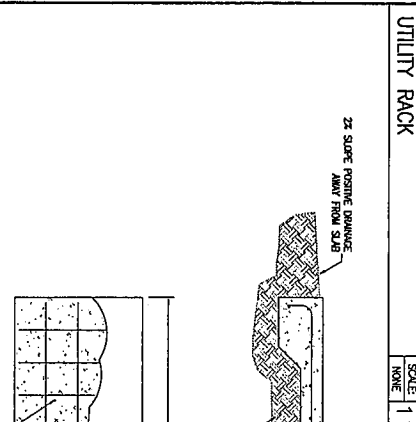
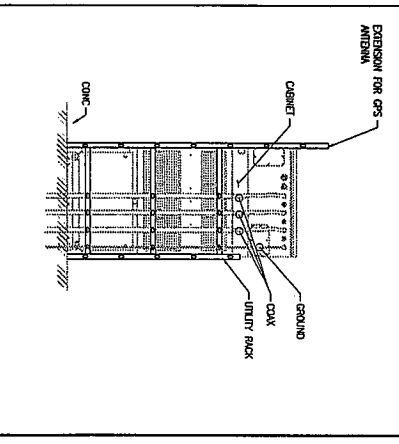
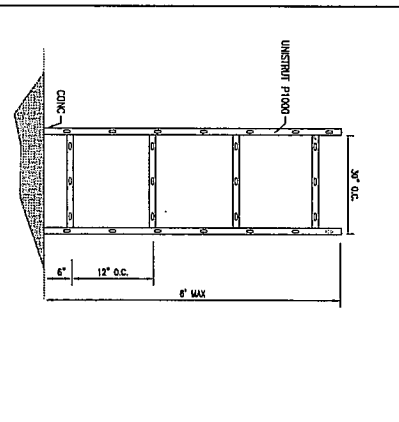
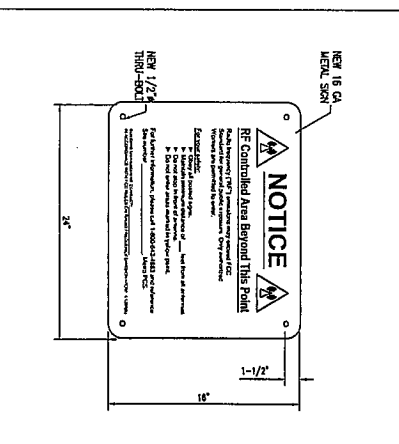
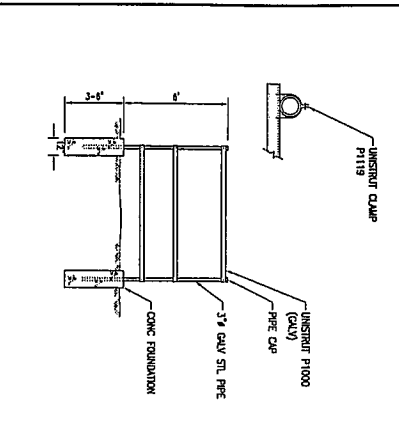

<p>CONCRETE PAD</p> <p>SCALE: NONE NAME: NONE</p>	<p>UTIL RACK SUPPORT</p> <p>SCALE: NONE NAME: NONE</p>	<p>CABINET ANCHOR BOLT</p> <p>SCALE: NONE NAME: NONE</p>
---	--	--

metropcs

Benjamin & Associates, Inc.
 P.O. Box 1423
 San Francisco, California 94116
 Ph 831-421-1216
 Fx 831-508-2189
 www.metropcs.com

REVISIONS

NO.	DATE	DESCRIPTION
1	02/17/05	100% CONSTRUCTION
2	03/14/05	80% CONSTRUCTION
3	05/02/05	FINAL ZONING REVIEW

THIS DRAWING IS COMPARED AND IS THE STATE OF THE ART. IT IS PROVIDED FOR YOUR INFORMATION AND IS NOT TO BE USED FOR ANY OTHER PURPOSE WITHOUT THE WRITTEN PERMISSION OF THE OWNER.

DRAWN BY: PJS
 CHECKED BY: AZB
 JOB NUMBER: 05113

SHEET TITLE: DETAILS

SHEET NUMBER: SF-16760A

SITE ADDRESS: 1590 MOFFETT STREET, SALINAS, CA 93905

SHEET: A-4

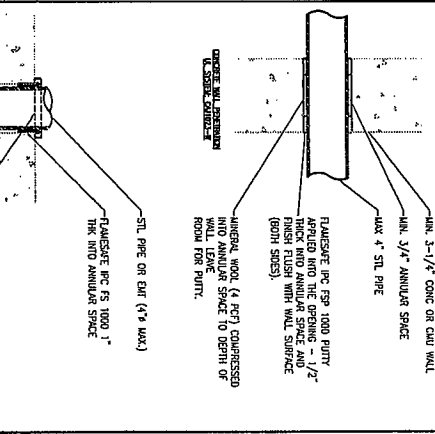
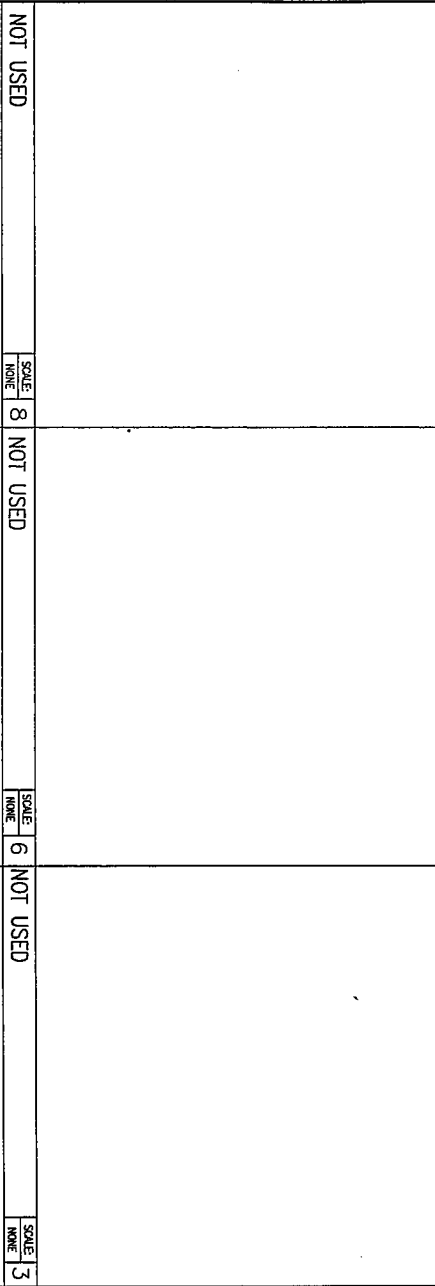
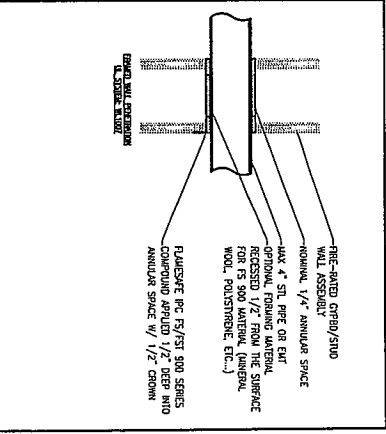
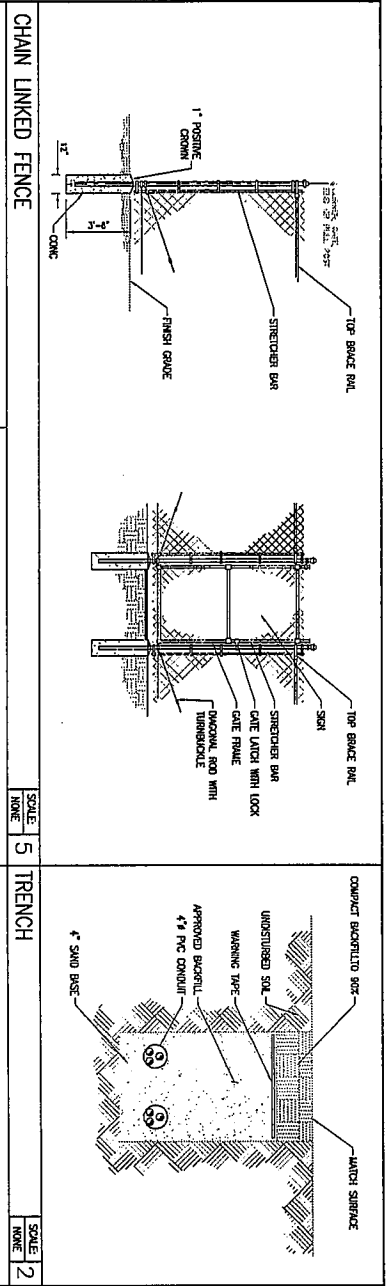

NOT USED	SCALE: NONE	NOT USED	SCALE: NONE	NOT USED	SCALE: NONE
NOT USED	SCALE: NONE	NOT USED	SCALE: NONE	NOT USED	SCALE: NONE
NOT USED	SCALE: NONE	NOT USED	SCALE: NONE	NOT USED	SCALE: NONE
NOT USED	SCALE: NONE	NOT USED	SCALE: NONE	NOT USED	SCALE: NONE

PENETRATION FIRESTOPPING

NOTE:
 1. CONDUITS TO 3-4" AIR SPACES TO BE MAINTAINED OR CONCRETE TO LOCATE (3) RE-GRIND DO NOT CUT RE-GRIND.
 2. ALL PENETRATIONS SHALL CONFORM TO TITLE 24, CALIF. BLDG. CODE, SECTION 714.
 3. PENETRATIONS THRU WALLS SHALL CONFORM WITH T24, CBC SECTION 709.6.
 4. PENETRATIONS THRU DOORS/CEILING SHALL CONFORM WITH T24, CBC SECTION 710.3. F RATING - PENETRATIONS 4" OR LESS T RATING - PENETRATIONS LARGER THAN 4". PENETRATIONS NOT CONTAINED W/IN A WALL.

metropcs

Benjamin & Associates, Inc.
 P.O. Box 16423
 San Francisco, California 94116
 PH: 415-774-1200
 FAX: 415-774-1210
 WWW: b-a-p-e.com

ISSUED: _____

NO. DATE _____

C 03/17/05 LOCK CONSTRUCTION

B 02/14/05 POZE CONSTRUCTION

A 03/09/05 POZE ZONING REVIEW

REVISIONS

NO.	DESCRIPTION

THE OWNER IS COMPEDED AND IS THE SOLE PROPRIETOR OF THE OWNER. IT IS PROHIBITED TO REPRODUCE OR TRANSMIT IN ANY FORM OR BY ANY MEANS, ELECTRONIC OR MECHANICAL, INCLUDING PHOTOCOPYING, RECORDING, OR BY ANY INFORMATION STORAGE AND RETRIEVAL SYSTEM, WITHOUT THE WRITTEN PERMISSION OF THE OWNER.

DRAWN BY: PJS
 CHECKED BY: AZB
 JOB NUMBER: 0513

SITE NAME: _____
 COUNTY OF MONTEREY
 TTD COMM. TOWER
 SITE NUMBER: _____
 SF-16780A
 SITE ADDRESS: _____
 1590 MOFFETT STREET
 SALINAS, CA 93905

SHEET TITLE: _____
 DETAILS

SHEET: _____

TOWER / STRUCTURE / EQUIPMENT
REMOVAL BOND

Exhibit C

Location of tower/structure/equipment:
Site Name & Address:

County of Monterey Information Technology
Department Communications Tower
1590 Moffett St.
Salinas, CA 93905
Site #: SF16760A

Bond Number: 104511492

KNOW ALL MEN BY THESE PRESENTS:

THAT MetroPCS Wireless, Inc., 8144 Walnut Hill Ln., #800, Dallas, TX 75231, as Principal, and Travelers Casualty and Surety Company of America, a corporation duly organized under the laws of the State of Connecticut as Surety, are held and firmly bound unto County of Monterey, c/o Real Property Specialist, 855 E. Laurel Dr., Building C, Salinas, CA 93905, as Obligee, the penal sum of ---Twenty-Five Thousand & no/100--- Dollars (\$25,000.00---) for the payment of which, well and truly to be made, we bind ourselves, our heirs, executors, administrators, successors and assigns, jointly and severally, firmly by these presents, the liability of the surety being limited to the penal sum of this bond regardless of the number of years the bond is in effect.

WHEREAS, the Principal has entered into a written agreement with the property owner for the placement of a tower, structure or equipment furnishing telephone, television or other electronic media service, which agreement sets forth the terms and conditions which govern the use of such towers, structures or equipment and which agreement is hereby specifically referred to and made part hereof, and

WHEREAS, the County of Monterey, CA (city/county ordinance and/or property owner), requires the submission of a bond guaranteeing the maintenance, replacement, removal or relocation of said tower,

NOW THEREFORE, the condition of this obligation is such, that if the above bounden Principal shall perform in accordance with the aforesaid ordinance and/or agreement, and indemnify the Obligee against all loss caused by Principal's breach of any ordinance or agreement relating to the maintenance, replacement, removal or relocation of a tower, structure or equipment, then this obligation to be void, otherwise to remain in full force and effect unless cancelled as set forth below.

THIS BOND may be cancelled by Surety by giving sixty (60) days written notice to the Obligee by registered mail. Such cancellation shall not affect any liability the surety has incurred under this bond prior to the effective date of the termination.

PROVIDED that no action, suit or proceeding shall be maintained against the Surety on this bond unless the action is brought within twelve (12) months of the cancellation date of this bond. If suit is brought upon this bond by the Obligee and judgment is recovered, the Surety shall pay all litigation expenses incurred by the Obligee in such suit, including attorney's fees, court costs, expert witness fees and investigation expenses.

SIGNED this 20th day of October, 2005 and to be effective October 20, 2005.

Principal: MetroPCS Wireless, Inc.

By: 

Surety: Travelers Casualty and Surety Company of America

By: 

Sharyl A. Markovits, Attorney-in-Fact



IMPORTANT DISCLOSURE NOTICE OF TERRORISM INSURANCE COVERAGE

On November 26, 2002, President Bush signed into law the Terrorism Risk Insurance Act of 2002 (the "Act"). The Act establishes a short-term program under which the Federal Government will share in the payment of covered losses caused by certain acts of international terrorism. We are providing you with this notice to inform you of the key features of the Act, and to let you know what effect, if any, the Act will have on your premium.

Under the Act, insurers are required to provide coverage for certain losses caused by international acts of terrorism as defined in the Act. The Act further provides that the Federal Government will pay a share of such losses. Specifically, the Federal Government will pay 90% of the amount of covered losses caused by certain acts of terrorism which is in excess of an insurer's statutorily established deductible for that year. The Act also caps the amount of terrorism-related losses for which the Federal Government or an insurer can be responsible at \$100,000,000,000.00, provided that the insurer has met its deductible.

Please note that passage of the Act does not result in any change in coverage under the attached policy or bond (or the policy or bond being quoted). Please also note that no separate additional premium charge has been made for the terrorism coverage required by the Act. The premium charge that is allocable to such coverage is inseparable from and imbedded in your overall premium, and is no more than one percent of your premium.

POWER OF ATTORNEY AND CERTIFICATE OF AUTHORITY OF ATTORNEY(S)-IN-FACT

KNOW ALL PERSONS BY THESE PRESENTS, THAT TRAVELERS CASUALTY AND SURETY COMPANY OF AMERICA, TRAVELERS CASUALTY AND SURETY COMPANY and FARMINGTON CASUALTY COMPANY, corporations duly organized under the laws of the State of Connecticut, and having their principal offices in the City of Hartford, County of Hartford, State of Connecticut, (hereinafter the "Companies") hath made, constituted and appointed, and do by these presents make, constitute and appoint: **David B. Ward, Sharyl A. Markovits, of Frisco, Texas,** their true and lawful Attorney(s)-in-Fact, with full power and authority hereby conferred to sign, execute and acknowledge, at any place within the United States, the following instrument(s): by his/her sole signature and act, any and all bonds, recognizances, contracts of indemnity, and other writings obligatory in the nature of a bond, recognizance, or conditional undertaking and any and all consents incident thereto *not exceeding the sum of TEN MILLION (\$10,000,000.00) DOLLARS per bond* and to bind the Companies, thereby as fully and to the same extent as if the same were signed by the duly authorized officers of the Companies, and all the acts of said Attorney(s)-in-Fact, pursuant to the authority herein given, are hereby ratified and confirmed.

This appointment is made under and by authority of the following Standing Resolutions of said Companies, which Resolutions are now in full force and effect:

VOTED: That the Chairman, the President, any Vice Chairman, any Executive Vice President, any Senior Vice President, any Vice President, any Second Vice President, the Treasurer, any Assistant Treasurer, the Corporate Secretary or any Assistant Secretary may appoint Attorneys-in-Fact and Agents to act for and on behalf of the company and may give such appointee such authority as his or her certificate of authority may prescribe to sign with the Company's name and seal with the Company's seal bonds, recognizances, contracts of indemnity, and other writings obligatory in the nature of a bond, recognizance, or conditional undertaking, and any of said officers or the Board of Directors at any time may remove any such appointee and revoke the power given him or her.

VOTED: That the Chairman, the President, any Vice Chairman, any Executive Vice President, any Senior Vice President or any Vice President may delegate all or any part of the foregoing authority to one or more officers or employees of this Company, provided that each such delegation is in writing and a copy thereof is filed in the office of the Secretary.

VOTED: That any bond, recognizance, contract of indemnity, or writing obligatory in the nature of a bond, recognizance, or conditional undertaking shall be valid and binding upon the Company when (a) signed by the President, any Vice Chairman, any Executive Vice President, any Senior Vice President or any Vice President, any Second Vice President, the Treasurer, any Assistant Treasurer, the Corporate Secretary or any Assistant Secretary and duly attested and sealed with the Company's seal by a Secretary or Assistant Secretary, or (b) duly executed (under seal, if required) by one or more Attorneys-in-Fact and Agents pursuant to the power prescribed in his or her certificate or their certificates of authority or by one or more Company officers pursuant to a written delegation of authority.

This Power of Attorney and Certificate of Authority is signed and sealed by facsimile (mechanical or printed) under and by authority of the following Standing Resolution voted by the Boards of Directors of TRAVELERS CASUALTY AND SURETY COMPANY OF AMERICA, TRAVELERS CASUALTY AND SURETY COMPANY and FARMINGTON CASUALTY COMPANY, which Resolution is now in full force and effect:

VOTED: That the signature of each of the following officers: President, any Executive Vice President, any Senior Vice President, any Vice President, any Assistant Vice President, any Secretary, any Assistant Secretary, and the seal of the Company may be affixed by facsimile to any power of attorney or to any certificate relating thereto appointing Resident Vice Presidents, Resident Assistant Secretaries or Attorneys-in-Fact for purposes only of executing and attesting bonds and undertakings and other writings obligatory in the nature thereof, and any such power of attorney or certificate bearing such facsimile signature or facsimile seal shall be valid and binding upon the Company and any such power so executed and certified by such facsimile signature and facsimile seal shall be valid and binding upon the Company in the future with respect to any bond or undertaking to which it is attached.

IN WITNESS WHEREOF, TRAVELERS CASUALTY AND SURETY COMPANY OF AMERICA, TRAVELERS CASUALTY AND SURETY COMPANY and FARMINGTON CASUALTY COMPANY have caused this instrument to be signed by their Senior Vice President and their corporate seals to be hereto affixed this 30th day of January 2002.

STATE OF CONNECTICUT

)SS. Hartford

COUNTY OF HARTFORD

TRAVELERS CASUALTY AND SURETY COMPANY OF AMERICA
TRAVELERS CASUALTY AND SURETY COMPANY
FARMINGTON CASUALTY COMPANY



By *George W. Thompson*
George W. Thompson
Senior Vice President

On this 30th day of January, 2002 before me personally came GEORGE W. THOMPSON to me known, who, being by me duly sworn, did depose and say: that he/she is Senior Vice President of TRAVELERS CASUALTY AND SURETY COMPANY OF AMERICA, TRAVELERS CASUALTY AND SURETY COMPANY and FARMINGTON CASUALTY COMPANY, the corporations described in and which executed the above instrument; that he/she knows the seals of said corporations; that the seals affixed to the said instrument are such corporate seals; and that he/she executed the said instrument on behalf of the corporations by authority of his/her office under the Standing Resolutions thereof.



Marie C. Tetreault
My commission expires June 30, 2006 Notary Public
Marie C. Tetreault

CERTIFICATE

I, the undersigned, Assistant Secretary of TRAVELERS CASUALTY AND SURETY COMPANY OF AMERICA, TRAVELERS CASUALTY AND SURETY COMPANY and FARMINGTON CASUALTY COMPANY, stock corporations of the State of Connecticut, DO HEREBY CERTIFY that the foregoing and attached Power of Attorney and Certificate of Authority remains in full force and has not been revoked; and furthermore, that the Standing Resolutions of the Boards of Directors, as set forth in the Certificate of Authority, are now in force.

Signed and Sealed at the Home Office of the Company, in the City of Hartford, State of Connecticut. Dated this 20th day of October, 2005.



By *Kori M. Johanson*
Kori M. Johanson
Assistant Secretary, Bond

Attachment "A"—Wireless Communication Site Lease Agreement

Exhibit D

NON-DISCLOSURE AGREEMENT

In order to protect certain Confidential Information (as defined below), MetroPCS California/Florida Inc., a Delaware corporation, d/b/a MetroPCS, for itself and its subsidiaries and affiliates, ("MetroPCS") and County of Monterey, for itself and its subsidiaries and affiliates ("Participant"), individually referred to as "Party" and collectively referred to as the "Parties" agree that:

1. **Effective Date.** The Effective Date of this Non-Disclosure Agreement ("Agreement") is 10/28/05.
2. **Mutual Agreement.** The Agreement shall apply to all Confidential Information disclosed either intentionally, or unintentionally.
3. **Additional Addenda.** In addition to this Agreement, the Parties may agree to additional matters in the form of fully executed Addenda that incorporate the terms of this Agreement.
4. **Confidential Information.** Confidential Information disclosed under this Agreement ("Confidential Information") is defined as personally identifiable information of a financial, healthcare, criminal justice, or other form; facility and electronic communications security provisions, tools, techniques, and methods; product and roadmap information; financial/pricing information; customer and vendor related data; services/support and other business information including, but not limited to, software, strategies, plans, techniques, drawings, designs, specifications, technical or know-how data, research and development, ideas, inventions, patent disclosures that may be disclosed between the parties whether in written, oral, electronic, website-based, or other form. This Agreement also includes Confidential Information acquired during any facilities access, tours, or conduct of business between the Parties.
5. **No Use of Name.** Without the prior written consent of the other Party, both Parties agree not to issue or release any articles, advertising, publicity or other matter relating to any Confidential Information (including the fact that a meeting or discussion has taken place between the Parties) or mentioning or implying the name of the other Party, except as may be required by law and then only after providing the other Party with an opportunity to review and comment thereon.
6. **Term and Purpose.** This Agreement shall remain in effect until it is terminated by either Party with thirty (30) days prior written notice. The terms and conditions of this Agreement shall survive any such terminations with respect to Confidential Information that is disclosed prior to the effective date of termination. The Parties receiving Confidential Information (each, a "Recipient") from the other Parties disclosing Confidential Information (each, a "Discloser") will use the Confidential Information only for the purpose of and in connection with the Parties' business relationship.
7. **Protection Period and Return of Information.** Unless the Parties otherwise agree in writing, a Recipient's duty to protect Confidential Information expires as defined by law or regulation but in no case sooner than three (3) years from the date of disclosure. A Recipient, upon Discloser's written request, will promptly return all Confidential Information received from the Discloser, together with all copies, or certify in writing that all such Confidential Information and copies thereof have been destroyed.
8. **Permitted Use.** A Recipient will use the same degree of care, but no less than a reasonable degree of care, as the Recipient uses with respect to its own similar information to protect the Confidential Information and to prevent (a) any use of Confidential Information not authorized in this Agreement, (b) dissemination of Confidential Information to any employee of Recipient without a need to know, (c) communication of Confidential Information to any third party or (d) publication of Confidential Information.
9. **Markings.** A Recipient will have a duty to protect Confidential Information (a) if it is marked or accompanied by documents clearly and conspicuously designating them as "confidential" or the equivalent, or (b) if it is identified by the Discloser as confidential before, during or promptly after the

Initials K _____

Attachment "A"— Wireless Communication Site Lease Agreement

- presentation or communication, or (c) if unmarked and unintentionally intercepted or received as a part of the parties business relationship.
10. **Exclusions.** This Agreement imposes no obligation upon a Recipient with respect to Confidential Information which (a) the Recipient can demonstrate was already in its possession before receipt from the Discloser; (b) is or becomes publicly available through no fault of the Recipient; (c) is rightfully received by the Recipient from a third party without a duty of confidentiality; (d) is disclosed by the Discloser to a third party without a duty of confidentiality on the third party; (e) is independently developed by the Recipient without a breach of this Agreement; or (f) is disclosed by the Recipient with the Discloser's prior written approval. If a Recipient is required by a government body or court of law to disclose Confidential Information, the Recipient agrees to give the Discloser reasonable advance notice so that Discloser may contest the disclosure or seek a protective order.
 11. **Disclaimers.** Each Discloser warrants that it has the right to disclose its Confidential Information when done so intentionally. No other warranties are made and no responsibility or liability is or will be accepted by either Party or as to the accuracy or completeness of the Confidential Information.
 12. **No Obligation.** This Agreement imposes no obligation on a Party to exchange Confidential Information or to purchase, sell, license, transfer or otherwise make use of any technology services or products.
 13. **Export Compliance.** A Recipient will adhere to all applicable laws and regulations of the U.S. Export Administration and will not export or re-export any technical data or products received from a Discloser, or the direct product of such technical data, to any proscribed country listed in the U.S. Export Administration regulations, or foreign national thereof, unless properly authorized by the U.S. Government.
 14. **Ownership.** No Party acquires any intellectual property rights under this Agreement except the limited rights necessary to carry out the purposes as set forth in this Agreement.
 15. **Remedies.** Each Party acknowledges that damages for improper disclosure of Confidential Information may be irreparable; therefore, the injured Party may be entitled to seek equitable relief, including injunction and preliminary injunction, in addition to all other remedies available at law or in equity.
 16. **Governing Law.** This Agreement is made under, and will be construed according to, the laws of the State of California.
 17. **Severability.** If any provision of this Agreement is found to be invalid or unenforceable in whole or in part, the Parties agree the remaining provisions of this Agreement shall remain valid and enforceable to the maximum extent compatible with existing law.
 18. **Miscellaneous.** The obligations and duties imposed by this Agreement with respect to any Confidential Information may be enforced by the Discloser of such Confidential Information against any and all Recipients of such Confidential Information. This Agreement does not create any agency or partnership relationship. This Agreement will not be assignable or transferable without the prior written consent of the other Party. All additions or modifications to this Agreement must be made in writing and must be signed by all Parties. Each Party agrees that facsimile signatures will have the same legal effect as originals signatures and may be used as evidence of execution.

MetroPCS *California / Florida, Inc.*
By: *HC Graves IV*
Name: HC Graves IV
Title: Vice President/General Manager
Address: 1080 Marina Village Pkwy #101
City, State, Zip: Alameda, CA 94501
09/28/05

County of Monterey
By: *[Signature]*
Name: *Mario S. [Signature]*
Title: **PURCHASING MANAGER
COUNTY OF MONTEREY**
Address:
City, State, Zip:

Initials *[Signature]*

Attachment "A"— Wireless Communication Site Lease Agreement

Date: _____ / _____ / _____

Date: _____ / _____ / _____

Initials *ly* _____