



## Monterey County Board of Supervisors

168 W. Alisal Street, 1<sup>st</sup> Floor  
Salinas, CA 93901  
831.755.5066  
[www.co.monterey.ca.us](http://www.co.monterey.ca.us)

### Board Order

A motion was made by Supervisor Chris Lopez, seconded by Supervisor Luis A. Alejo to Adopt Resolution No.19-137 to:

- a. Certify the Board considered the Negative Declaration previously adopted for the Combined Development Permit; and
- b. Approve an amendment to a previously approved Combined Development Permit (PLN150755) to allow the following modifications:
  - a. Relocation of the fire pit away from property line
  - b. Removal of the gate entrance in the fence along the creek side of the property
  - c. Revisions to the underground drainage plan which move the holding tanks away from the property line
  - d. Inclusion of additional evidence regarding ESHA (Finding 6, Evidence 'd')

Resolution includes findings and evidence, and;

Staff recommends approval subject to eighteen (18) conditions.

PASSED AND ADOPTED on this 7<sup>th</sup> day of May 2019, by the following vote, to wit:

AYES: Supervisors Alejo, Lopez, Adams, Parker and Phillips

NOES: None

ABSENT: None

I, Valerie Ralph, Clerk of the Board of Supervisors of the County of Monterey, State of California, hereby certify that the foregoing is a true copy of an original order of said Board of Supervisors duly made and entered in the minutes thereof of Minute Book 82 for the meeting May 7, 2019.

Dated: May 10, 2019  
Legistar File ID No. RES 19-049  
Agenda Item No. 12

Valerie Ralph, Clerk of the Board of Supervisors  
County of Monterey, State of California

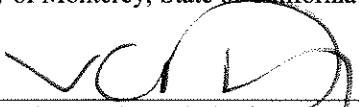
  
\_\_\_\_\_  
Valerie Ralph, Clerk of the Board

**RESOLUTION**

**Before the Board of Supervisors in and for the  
County of Monterey, State of California**

In the matter of the application of:

**RAVEN (PLN150755-AMD1)**

**RESOLUTION NO. 19-137**

Resolution by the Monterey County Board of Supervisors to:

- 1) Consider a Negative Declaration adopted for the Combined Development Permit; and
- 2) Approve an amendment to a previously approved Combined Development Permit (PLN150755) to allow the following modifications:
  - a. Relocation of the fire pit away from property line
  - b. Removal of the gate entrance in the fence along the creek side of the property
  - c. Revisions to the underground drainage plan which move the holding tanks away from the property line
  - d. Inclusion of additional evidence regarding ESHA (Finding 6, Evidence ‘d’)

3213 Whitman Lane, Pebble Beach, Del Monte Forest Land Use Plan, Coastal Zone (APN: 008-401-010-000)

**An Amendment to a previously approved Combined Development Permit (Raven application - PLN150755-AMD1) came on for a public hearing before the Monterey County Board of Supervisors on May 7, 2019. Having considered all the written and documentary evidence, the administrative record, the staff report, oral testimony, and other evidence presented, the Board of Supervisors finds and decides as follows:**

**FINDINGS**

1. **FINDING:** **PROCESS** – The County has processed the subject application (RMA-Planning File No. PLN150755-AMD1/Raven) for an amendment to Combined Development Permit (“Project”) in compliance with all applicable procedural requirements.  
**EVIDENCE:** a) On July 10, 2018, the Board of Supervisors heard the appeal of Ted Muhs and Elizabeth McGinnis, Glen and Angela Charles, Richard and Kathleen Doerr, Charles and Helen Schwab, and Sally Lucas from the April 26, 2018 Zoning Administrator’s approval of the Raven’s application (PLN150755) for a Combined Development Permit. The Board denied the appeal, adopted a Negative Declaration for the project, and approved the Raven application. (Board of Supervisors’ Resolution No. 18-215.). A Final Local Action Notice (FLAN) (File No. 3-MCO-18-0969) was sent to California Coastal

Commission (CCC) staff on August 30, 2018. On September 21, 2018, CCC staff notified the County of Monterey and the applicant via mail of a pending appeal of the Raven application (CCC Appeal No. A-3-MCO-18-0061). Prior to the application being scheduled before the Coastal Commission on appeal, the applicant notified the County of their desire to modify certain portions of the project contested during the appeal including the placement of a fire pit, gate access to the canyon, and location of development near trees on neighboring properties.

- b) Monterey County staff notified the Coastal Commission staff and the FLAN was withdrawn and the appeal was subsequently closed by CCC staff. Withdrawal of the FLAN and removal of the appeal to the Coastal Commission does not rescind the Board of Supervisors' July 10, 2018 adoption of the Negative Declaration and approval of the Combined Development. Accordingly, applicant's request to modify the project comes before the Board of Supervisors as an amendment to the previously adopted Combined Development Permit. A new FLAN will be required to be sent to the Coastal Commission. Except as modified, the previously approved Combined Development Permit remains in effect.
- c) The application, project plans, and related support materials submitted by the project applicant to Monterey County RMA-Planning for the proposed development found in Project File Nos. PLN150755 and PLN150755-AMD1.

2. **FINDING:** **CONSISTENCY** – The Project, as conditioned, is consistent with the applicable plans and policies which designate this area as appropriate for development.

- EVIDENCE:**
- a) During the course of review of this application, the project has been reviewed for consistency with the text, policies, and regulations in:
    - the 1982 Monterey County General Plan;
    - Del Monte Forest Land Use Plan;
    - Monterey County Coastal Implementation Plan Part 5;
    - Monterey County Zoning Ordinance (Title 20);

No conflicts were found to exist. The County finds that the project is consistent with the text, policies, and regulations in the applicable documents

- b) On July 10, 2018, the Board of Supervisors considered and approved the Raven application as follows:
  - 3) a Combined Development Permit consisting of:
    - a. Coastal Administrative Permit and Design Approval to allow the construction of a single family dwelling consisting of 2,306 square foot two story, 1,690 square foot basement and a 298 square foot garage;
    - b. Coastal Development Permit to allow development within 750 feet of an archaeological resource; and
    - c. Variance to exceed lot coverage by 3.9% (totaling 18.9%); and
    - d. Variance to exceed floor area ratio FAR by 5.3% (totaling 22.8%).

The following modifications have been added to the previously approved project:

- Revising the underground drainage plan to move the holding tanks away from the property line to avoid any tree root damage.
- Moving the proposed fire pit away from property line and into the back patio;
- Removing the gate originally in the fence line along the creek side of the property.;

The County has also added a Finding & Evidence related to development within 100 feet of ESHA. Except as modified by this amendment, the Combined Development Permit as approved on July 10, 2018 remains in effect.

- c) The property is located at 3213 Whitman Lane, Pebble Beach (Assessor's Parcel Number 008-401-010-000), Del Monte Forest (DMF) Land Use Plan (LUP), Coastal Zone. The parcel is zoned Low Density Residential, 1.5 acres per unit, with a Design Control zoning overlay (Coastal Zone) [LDR/1.5-D (CZ)]. Development of single-family dwellings and non-habitable accessory structures are identified as allowed uses pursuant to MCC Sections 20.14.040.A and F, subject to the granting of applicable coastal development permits. The Design Control zoning overlay requires the granting of a Design Approval for the proposed development (see Finding No. 2 below).
- d) The .262-acre (11,413 square feet) lot is a legal lot of record. (See Unconditional Certificate of Compliance (COC030103).)
- e) No Violations: The subject property is in compliance with all rules and regulations pertaining to zoning uses and applicable provisions of Title 20. There are no violations, so there are no outstanding zoning violation abatement costs. Monterey County RMA-Planning and RMA-Building Services records were reviewed, and the County is not aware of any violations existing on subject property.
- f) History: The approximately 0.262 acre parcel was the site of the former Pebble Beach golf course maintenance facility, but has since been cleared of all structures and other features (including underground storage tanks). The site was covered by a 2,700 square foot maintenance building, a lean-to shed, a concrete pad and asphalt concrete yard area. In addition, a fueling facility and underground storage tanks were also located in the central part of the yard. The fueling facility was inactive around October 2003 and staff has confirmed that the tanks were properly removed according to all County regulations in early 2004. Demolition activities and interim uses for materials and equipment stockpiling and storage have eliminated any sustainable habitat for native populations of plants or animals.
- g) Pescadero Watershed: The project is located on the edge of the Del Monte Forest Watershed Boundary, within an un-named watershed. Policy 77 of the Del Monte Forest Land Use Plan limits development of parcels within the applicable watersheds to a maximum site

coverage of 9,000 square feet, including both structural and impervious surface coverages. The intent of this policy is to reduce runoff into the waters of the Pacific Ocean surrounding the Del Monte Forest, specifically the Carmel Bay Area of Special Biological Significance (ASBS). Maximum coverage for the proposed project is 7,002 square feet (including covered patios, which is well under the maximum allowed). Although Variances are proposed, the structure meets all other site development standards (i.e., setbacks, height) within the LDR zoning district.

Monterey County Water Resources Agency and RMA-Environmental Services reviewed the submitted application materials, and applied conditions as necessary to ensure drainage or runoff design measures are implemented. Implementation of these conditions would ensure compliance with the stormwater policies of the Del Monte Forest Land Use Plan to provide on-site retention to prevent off-site discharge from storms. In addition, the storm drain on Whitman Lane is part of the Pebble Beach CSD storm drainage infrastructure. According to the Water Resources, discharging to existing storm drain infrastructure is acceptable and does not conflict with any drainage law. WRA has accepted the proposed drainage plan.

- h) Cultural Resources. The project site is in an area identified in County records as having a high archaeological sensitivity, and is within 750 feet of known archaeological resources. A “Preliminary Archaeological Reconnaissance” was prepared by Archaeological Consulting for the project site to evaluate potential resources on or within the vicinity of the site, which could be impacted by the proposed residential development on the project site. At the time of the reconnaissance, the parcel contained the existing maintenance building, asphalt pavements, a small pesticide shed and piles of various plastic pipes, plywood, vehicles, etc. Some soil was visible in the center of the parcel where a fuel tank had been removed. None of the materials frequently associated with prehistoric cultural resources in this area were observed during the field reconnaissance. Based upon the background research and field reconnaissance, it has been concluded that there is no surface evidence of potentially significant archaeological resources on the project parcel. Therefore, there is no evidence that any cultural resources would be disturbed, and the potential for inadvertent impacts to cultural resources is limited and will be controlled by application of the County’s standard project condition (Condition No. 3) which requires the contractor to stop work if previously unidentified resources are discovered during construction.
- i) ESHA. Pursuant to Section 20.14.030 of Monterey County Code, a Coastal Development Permit is required for Development within 100 feet of mapped or field identified environmentally sensitive habitats (ESHA). Although approximately 90 feet from ESHA, an entitlement is required for the development. The purpose of setbacks from ESHA is for protection of sensitive resources and to avoid the degradation of otherwise healthy sensitive habitat. According to Patrick Regan’s peer review of prior biological assessments, this

habitat (Stillwater Creek) is seriously disturbed and degraded. The project as designed will not impact the physical attributes or vegetation of the creek canyon and will not degrade the habitat value of the Stillwater creek and surrounding habitat. (See discussion in ESHA Finding #6)

- j) The application, plans, and supporting materials submitted by the project applicant to Monterey County RMA-Planning for the proposed development found in project files PLN150755 and PLN150755-AMD1.

3. **FINDING:** **SITE SUITABILITY** – The site is physically suitable for the use proposed.

**EVIDENCE:** a) The project has been reviewed for site suitability by RMA-Planning, RMA-Public Works, RMA-Environmental Services, Pebble Beach Community Services District (Fire Protection District), and Monterey County Water Resources Agency. There has been no indication from these departments/agencies that the site is not suitable for the proposed development. Conditions recommended have been incorporated.

b) The following technical reports have been prepared:

- Preliminary Biological Resource Reconnaissance (LIB160343), prepared by Zander Associates, Berkeley, CA, June 13, 2106;
- Assessment of Resource Values Associated with Stillwater Creek & Adjoining Private Properties, prepared by Jeffrey B. Froke, Ph.D., Pebble Beach CA, dated October 26, 2016;
- Updated Soil Sampling and Analysis Report, Former Pebble Beach Golf Course Maintenance Facility, Whitman Lane, Pebble Beach, prepared by D&M Consulting Engineers, Inc., dated October 20, 2003;
- Preliminary Archaeological Assessment (LIB090296) prepared by Archaeological Consulting, Salinas, California, June 2, 2009;
- Soil Engineering Investigation for Raven Residence at 3213 Whitman Lane, Pebble Beach (LIB160055), prepared by LandSet Engineers, Inc., Salinas, CA, dated January, 2016;
- 2016 CBC Soil Engineering Investigation Update for Raven Residence, prepared by LandSet Engineers, Inc., Salinas, CA, dated September 27, 2017;
- Peer Review of Project Impact Assessment by Frank Ono Consulting (LIB190086) prepared by Pat Regan, August 16, 2018;
- Peer Review of Biological Assessments by M. Zander and J. Froke (LIB190087) prepared by Pat Regan, July 14, 2018

The above-mentioned technical reports by outside consultants indicate that there are no physical or environmental constraints that would indicate that the site is not suitable for the use proposed. County staff has independently reviewed these reports and concurs with their conclusions.

- c) County staff reviewed the application materials and plans, as well as the County’s GIS database, to verify that the proposed project on the subject site conforms to the applicable plans, and that the site is suitable for the proposed development.

4. **FINDING:** **HEALTH AND SAFETY** - The establishment, maintenance, or operation of the project applied for will not under the circumstances of this particular case be detrimental to the health, safety, peace, morals, comfort, and general welfare of persons residing or working in the neighborhood of such proposed use, or be detrimental or injurious to property and improvements in the neighborhood or to the general welfare of the County.

- EVIDENCE:**
- a) The project was reviewed by the RMA - Planning, Pebble Beach Community Services District, Public Works, RMA Environmental Services, Environmental Health Bureau, and Water Resources Agency. The respective agencies have recommended conditions, where appropriate, to ensure that the project will not have an adverse effect on the health, safety, and welfare of persons either residing or working in the neighborhood.
  - b) Necessary public facilities are available for the single family dwelling. The property is and will be served by a public water system (California American Water) and an existing public sewer system (Pebble Beach Community Services District and Carmel Area Wastewater District). The Environmental Health Bureau did not impose any conditions for project approval

5. **FINDING:** **DESIGN** – The design of the proposed project assures protection of the public viewshed, is consistent with neighborhood character, and assures visual integrity without imposing undue restrictions on private property.

- EVIDENCE:**
- a) The proposed project would re-develop an existing previously disturbed 0.262-acre (11,413 square foot) lot with a single-family dwelling with attached garage.
  - b) The proposed project site and surrounding area are designated as a Design Control Combining District (D District), subject to Chapter 20.44 of Title 20 (Coastal Zoning Ordinance) of the Monterey County Code (MCC), which regulates the location, size, configuration, materials, and colors of structures and fences to assure the protection of the public viewshed and neighborhood character.
  - c) Material and Color Finishes. The proposed exterior colors and materials are consistent with the residential setting and other dwelling units in the immediate vicinity. The primary colors and materials include tan stucco and natural wood doors and windows, copper accents, a metal gate and clay tile roofing materials. The second story is set back from the first story so as to prevent the feeling of a box-type structure. A variety of roof pitches help to soften the height of the structure. Exterior finishes include several openings along with shutters, stained wood beams, rafter tails and outriggers, which allow the structure to blend with the environment, blend with the residential character of the neighborhood, and is consistent with other dwellings in the neighborhood. The only exterior changes made to

the original design include moving fire pit away from property line and removing the gate entrance to the creek.

- d) Visual Resources. The subject property is located in an area where the Local Coastal Program may require visual public access (Figure 3, Visual Resources, Del Monte Forest Land Use Plan). Portions of the Whitman Drive enclave are visible from Point Lobos Reserve at a distance of over three miles. However, the subject property is in the northernmost portion (rear) of the enclave and is fully shielded from Point Lobos by topography. The project site and the Whitman Drive enclave are also visible from Seventeen Mile Drive across the 15<sup>th</sup> fairway of the Pebble Beach Golf Course. At the closest point, the site is about 300 feet from Seventeen Mile Drive. That portion of Seventeen Mile Drive is two lanes with minimal shoulders. While there are clear views towards the site, there is ample screening along Seventeen Mile Drive, the 15<sup>th</sup> hole, and along the parcel itself to minimize the view of the project to the public. The proposed two-story structure is well below the existing trees on the property. The proposed home will also be subject to County lighting conditions to prevent light pollution and intrusion into the public viewshed. In addition to screening, due to the speed of traffic, and the length of the visible window to the project site, there is only a short duration that the project site is visible at all. The proposed development is consistent with Del Monte Forest Land Use Plan Policies 123 and 137, and will not block significant public views toward the ocean and will not adversely impact the public viewshed or scenic character in the project vicinity.

As sited and designed the proposed house will not have a significant visual impact on the area's scenic resources. Standard conditions of approval will require landscaping and exterior lighting plans. Approval of colors and materials have been approved as consistent. The proposed structure will only retain and enhance the public's visual access, and would be visually compatible with other structures in the site vicinity. As proposed, the project would not result in any visual impacts, and the project is consistent with the applicable visual resource and public access policies of the Del Monte Forest Land Use Plan.

- e) Review of Development Standards. The development standards for the LDR zoning district are identified in MCC Section 20.14.060. Required setbacks in the LDR district for main dwelling units are 30 feet (front), 20 feet (rear), and 20 feet (sides). As proposed, the structure meets or exceeds all required setbacks. Corresponding maximum structure height is 30 feet, proposed is 29.9 feet. A height verification condition of approval has been included (Condition #9). The Combined Development approved by the Board on July 10, 2018, included a variance allowing the project to exceed lot coverage and Floor Area Ratio (FAR), as the lot is substantially smaller than other lots within this Whitman enclave.



- f) The project planner conducted a site inspections on August 17 and September 21, 2017 to verify that the proposed project on the subject parcel conforms to the applicable plans and MCC, and will not adversely impact the neighborhood character or scenic/visual resources.

6. **FINDING:** **ESHA** - Policy 8 of the Del Monte Forest Land Use Plan states that “environmentally sensitive habitat areas be protected against any significant disruption of habitat values. Land uses and development adjacent to environmentally sensitive habitat areas shall be compatible with long-term maintenance of the habitat area, and such land use and development shall be sited and designed to prevent impacts that would significantly degrade the habitat areas.”

- EVIDENCE:**
- a) A Biological Assessment was prepared by Zander and Associates in June 2016 for the applicant, to determine the potential impacts to any environmentally sensitive habitat which could be located on the project site. The Biological Assessment concluded there are no sensitive biological resources on the subject property. The history of use of the lot has eliminated any natural vegetation and wildlife habitat characteristics on the site. A single coast live oak along the westerly fence line was the only tree within the fenced perimeter of the lot.
- b) An additional Biological Assessment of Resource Values Associated with Stillwater Creek and Adjoining Private Properties prepared by Jeff Froke in October 2016, was submitted by the appellants’ attorney. It confirms that Stillwater Creek is a riparian resource and qualifies as ESHA. The report purports no connection to the Raven project other than to reflect a collegial agreement between Mr. Zander and Mr. Froke to maintain a dialog regarding iota of the Stillwater Creek environment.
- c) At peer review of the Biological Assessments prepared by Michael Zander and Jeffrey Froke was submitted by Patrick Regan to the applicants on July 14, 2018. The report was submitted to the County in 2019 as part of this amendment Based on the review of the reports and survey of the area, it is clear that the assessment created by Mr. Zander considered the actual project site from a biological impacts perspective, and he rightly determined that no sensitive species or habitat would be directly impact by the development of the lot and that indirect impacts to surrounding properties would be less than significant as long as basic common conditions such as appropriate timed bird nest surveys, standard erosion control and other best management practices were applied.
- d) “In addition to environmentally sensitive habitat area policies that may apply, riparian plant communities shall be protected by establishing a setback/buffer of at least 100 feet as measured from the outer edge of riparian vegetation. The setback/buffer requirement may be reduced only if it is clearly demonstrated that a narrower setback/buffer is sufficient to protect riparian vegetation and associated wildlife values and other ecological functions” (Policy 23 Del Monte Forest Land Use Plan)). Stillwater Creek is classified by the United States Fish and Wildlife Service National Wetlands database by Classification code: R4SBA, which means it is a temporarily flowing riverine channel or

intermittent river-like system that occasionally floods. Although the creek is considered a wetland, which does qualify as ESHA, the reach of the actual delineable wetland is located only at the very bottom of the canyon. The canyon that Stillwater creek flows through is old enough and incised enough that the vegetation growing at the top and down each side is not dependent upon the stream flow for survival. The project home will be less than 100 feet when measured on a straight line from the structure to a point in midair over the canyon bottom where the wetland vegetation begins. The ground plane distance from the southwest corner of the house to the beginning of the daylighted creek “canal” and actual wetland plants begins to occur at 97 feet. However, Stillwater Creek is seriously disturbed and degraded. The project as designed will not impact the physical attributes or vegetation of the creek canyon; and therefore, the narrower setback is sufficient.

7. **FINDING:** **CEQA (Negative Declaration)** – The Board of Supervisors has considered the Negative Declaration previously adopted for the Combined Development Permit. The amendment to the Combined Development Permit consists of minor modifications as described above. These project modifications do not require major revisions of the Negative Declaration, as they do not involve new significant environmental effects or increase the severity of any previously identified potential environmental impacts. Additionally, there are no substantial changes in circumstances or new information of substantial importance, which was not known or could not have been known with reasonable diligence at the time of adoption of the Negative Declaration, that shows that the project would have one or more significant effects not discussed in the Negative Declaration or that show that potentially significant effects previously discussed would be substantially more severe than shown in the previous Negative Declaration.

- EVIDENCE:**
- a) Monterey County RMA-Planning prepared an Initial Study pursuant to CEQA. The Initial Study is on file in the offices of RMA-Planning and is hereby incorporated by reference (PLN150755).
  - b) An Initial Study/ Draft Negative Declaration (ND) was prepared in accordance with CEQA and circulated for public review from March 16, 2018 to April 16, 2018. The Board of Supervisors adopted the Negative Declaration on July 10, 2018 prior to approving the Combined Development Permit (PLN150755).
  - c) Moving the fire pit further from the property line and removing the gate altogether from the fence reduces any impacts already analyzed in the Initial Study. Originally, both project components were closer to the canyon; and the gate could have potentially impacted canyon access. Moving the fire pit closer to the house also reduces the potential for nuisance from noise impacting the closest neighbors. Adding the ESHA Finding merely clarifies and amplifies and does not change the conclusion of the Negative Declaration. Monterey County RMA-Planning, located at 1441 Schilling Place, 2<sup>nd</sup> Floor, Salinas, California, 93901, is the custodian of documents and other

materials that constitute the record of proceedings upon which the decision to adopt the mitigated negative declaration is based.

8. **FINDING:** **PUBLIC ACCESS** – The project is in conformance with the public access and recreation policies of the Coastal Act (specifically Chapter 3 of the Coastal Act of 1976, commencing with Section 30200 of the Public Resources Code) and Local Coastal Program, and does not interfere with any form of historic public use or trust rights.

- EVIDENCE:**
- a) No access is required as part of the project as no substantial adverse impact on access, either individually or cumulatively, as described in Section 20.147.130 of the Monterey County Coastal Implementation Plan can be demonstrated.
  - b) No evidence or documentation has been submitted or found showing the existence of historic public use or trust rights over this property.
  - c) The subject property is not described as an area where the Local Coastal Program requires physical public access (Figure 8, Major Public Access and Recreational Facilities, in the Del Monte Forest Land Use Plan).
  - d) The subject property is identified as an area where the Local Coastal Program may require visual public access (Figure 3, Visual Resources, Del Monte Forest Land Use Plan). See also Finding No. 2.
  - e) The proposed development is consistent with Del Monte Forest Land Use Plan Policies 123 and 137, and will not block significant public views toward the ocean and will not adversely impact the public viewshed or scenic character in the project vicinity. As proposed, the project is consistent with applicable visual resource and public access policies in the Del Monte Forest Land Use Plan.
  - f) The project planner completed site inspections on August 17, September 21, 2017, to verify that the proposed project would not impact public access. The project planner also reviewed plans and visual simulations of the proposed development to verify that the structures will not impact visual resources/access.
  - g) The application, plans and supporting materials submitted by the project applicant to Monterey County RMA-Planning for the proposed development are found in Project Files PLN150755 and PLN150755-AMD1.

9. **FINDING:** **APPEALABILITY** – The decision on this project may be appealed to the California Coastal Commission.

- EVIDENCE:**
- a) California Coastal Commission: Pursuant to Section 20.86.080.A of the Monterey County Zoning Ordinance (Title 20), the project is subject to appeal by/to the California Coastal Commission because it involves development between the sea and the first through public road paralleling the sea (State Route 1), and development that is permitted in the underlying zone as a conditional use.

**DECISION**

**NOW, THEREFORE BE IT RESOLVED**, based on the above findings and evidence, and the administrative record as a whole, that the Board of Supervisors does hereby:

- 1) Certify that the Board considered the Negative Declaration adopted for the Combined Development Permit; and
- 2) Approve an amendment to a previously approved Combined Development Permit (PLN150755) to allow the following modifications:
  - a. Relocation of the fire pit away from property line
  - b. Removal of the gate entrance in the fence along the creek side of the property
  - c. Revisions to the underground drainage plan which move the holding tanks away from the property line
  - d. Inclusion of additional evidence regarding ESHA (Finding 6, Evidence 'd')

In general conformance with the attached plans and subject to the conditions of approval, both being attached hereto and incorporated herein by reference. Except as modified herein, the previously approved Combined Development Permit remains in effect.

**PASSED AND ADOPTED** upon motion of Supervisor Lopez, seconded by Supervisor Alejo, and carried this 7<sup>th</sup> day of May, 2019, by the following vote to wit:

AYES: Supervisors Lopez, Alejo, Parker, Adams and Phillips  
NOES: None  
ABSENT: None  
ABSTAIN: None

I, Valerie Ralph, Clerk of the Board of Supervisors of the County of Monterey, State of California, hereby certify that the foregoing is a true copy of an original order of said Board of Supervisors duly made and entered in the minutes thereof Minute Book 82 for the meeting on May 7, 2019.

Date: May 9, 2019  
Legistar File Number: RES 19-049  
Agenda Item No. 12

Valerie Ralph, Clerk of the Board of Supervisors  
County of Monterey, State of California

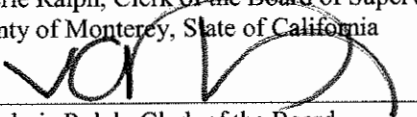
By   
Valerie Ralph, Clerk of the Board

# Monterey County RMA Planning

## Conditions of Approval/Implementation Plan/Mitigation Monitoring and Reporting Plan

PLN150755-AMD1

### 1. PD001 - SPECIFIC USES ONLY

**Responsible Department:** RMA-Planning

**Condition/Mitigation Monitoring Measure:** This amendment to a previously approved Combined development Permit (PLN150755) to allow the following modifications:

- a. Relocation of the fire pit away from property line
- b. Removal of the gate entrance in the fence along the creek side of the property
- c. Revisions to the underground drainage plan which move the holding tanks away from the property line
- d. Inclusion of additional evidence regarding ESHA (Finding 6, Evidence 'd')

The property is located at 3213 Whitman Lane, Pebble Beach, Del Monte Forest Land Use Plan, Coastal Zone (APN: 008-401-010-000) Del Monte Forest Land Use Plan. This permit was approved in accordance with County ordinances and land use regulations subject to the terms and conditions described in the project file. Neither the uses nor the construction allowed by this permit shall commence unless and until all of the conditions of this permit are met to the satisfaction of the Director of RMA - Planning. Any use or construction not in substantial conformance with the terms and conditions of this permit is a violation of County regulations and may result in modification or revocation of this permit and subsequent legal action. No use or construction other than that specified by this permit is allowed unless additional permits are approved by the appropriate authorities. To the extent that the County has delegated any condition compliance or mitigation monitoring to the Monterey County Water Resources Agency, the Water Resources Agency shall provide all information requested by the County and the County shall bear ultimate responsibility to ensure that conditions and mitigation measures are properly fulfilled. (RMA - Planning)

**Compliance or Monitoring Action to be Performed:** The Owner/Applicant shall adhere to conditions and uses specified in the permit on an ongoing basis unless otherwise stated.

**2. PD002 - NOTICE PERMIT APPROVAL**

**Responsible Department:** RMA-Planning

**Condition/Mitigation Monitoring Measure:** The applicant shall record a Permit Approval Notice. This notice shall state:  
 "An Amendment (PLN150755-AMD1) to Combined Development Permit (Resolution Number 19-137) was approved by the Board of Supervisors for Assessor's Parcel Number 008-401-010-000 on May 7, 2019. The permit was granted subject to 18 conditions of approval which run with the land. A copy of the permit is on file with Monterey County RMA - Planning."

Proof of recordation of this notice shall be furnished to the Director of RMA - Planning prior to issuance of grading and building permits, Certificates of Compliance, or commencement of use, whichever occurs first and as applicable. (RMA - Planning)

**Compliance or Monitoring Action to be Performed:** Prior to the issuance of grading and building permits, certificates of compliance, or commencement of use, whichever occurs first and as applicable, the Owner/Applicant shall provide proof of recordation of this notice to the RMA - Planning.

**3. PD003(A) - CULTURAL RESOURCES NEGATIVE ARCHAEOLOGICAL REPORT**

**Responsible Department:** RMA-Planning

**Condition/Mitigation Monitoring Measure:** If, during the course of construction, cultural, archaeological, historical or paleontological resources are uncovered at the site (surface or subsurface resources) work shall be halted immediately within 50 meters (165 feet) of the find until a qualified professional archaeologist can evaluate it. Monterey County RMA - Planning and a qualified archaeologist (i.e., an archaeologist registered with the Register of Professional Archaeologists) shall be immediately contacted by the responsible individual present on-site. When contacted, the project planner and the archaeologist shall immediately visit the site to determine the extent of the resources and to develop proper mitigation measures required for recovery.  
 (RMA - Planning)

**Compliance or Monitoring Action to be Performed:** The Owner/Applicant shall adhere to this condition on an on-going basis.

Prior to the issuance of grading or building permits and/or prior to the recordation of the final/parcel map, whichever occurs first, the Owner/Applicant shall include requirements of this condition as a note on all grading and building plans. The note shall state "Stop work within 50 meters (165 feet) of uncovered resource and contact Monterey County RMA - Planning and a qualified archaeologist immediately if cultural, archaeological, historical or paleontological resources are uncovered."

When contacted, the project planner and the archaeologist shall immediately visit the site to determine the extent of the resources and to develop proper mitigation measures required for the discovery.

**4. PD006(A) - CONDITION COMPLIANCE FEE**

**Responsible Department:** RMA-Planning

**Condition/Mitigation Monitoring Measure:** The Owner/Applicant shall pay the Condition Compliance fee, as set forth in the fee schedule adopted by the Board of Supervisors, for the staff time required to satisfy conditions of approval. The fee in effect at the time of payment shall be paid prior to clearing any conditions of approval.

**Compliance or Monitoring Action to be Performed:** Prior to clearance of conditions, the Owner/Applicant shall pay the Condition Compliance fee, as set forth in the fee schedule adopted by the Board of Supervisors.

**5. CC01 INDEMNIFICATION AGREEMENT**

**Responsible Department:** County Counsel-Risk Management

**Condition/Mitigation Monitoring Measure:** The property owner agrees as a condition and in consideration of approval of this discretionary development permit that it will, pursuant to agreement and/or statutory provisions as applicable, including but not limited to Government Code Section 66474.9, defend, indemnify and hold harmless the County of Monterey or its agents, officers and employees from any claim, action or proceeding against the County or its agents, officers or employees to attack, set aside, void or annul this approval, which action is brought within the time period provided for under law, including but not limited to, Government Code Section 66499.37, as applicable. The property owner will reimburse the County for any court costs and attorney's fees which the County may be required by a court to pay as a result of such action. The County may, at its sole discretion, participate in the defense of such action; but such participation shall not relieve applicant of his/her/its obligations under this condition. An agreement to this effect shall be recorded upon demand of County Counsel or concurrent with the issuance of building permits, use of property, filing of the final map, recordation of the certificates of compliance whichever occurs first and as applicable. The County shall promptly notify the property owner of any such claim, action or proceeding and the County shall cooperate fully in the defense thereof. If the County fails to promptly notify the property owner of any such claim, action or proceeding or fails to cooperate fully in the defense thereof, the property owner shall not thereafter be responsible to defend, indemnify or hold the County harmless. (County Counsel-Risk Management)

**Compliance or Monitoring Action to be Performed:** Upon demand of County Counsel or concurrent with the issuance of building permits, use of the property, recording of the final/parcel map, or recordation of Certificates of Compliance, whichever occurs first and as applicable, the Owner/Applicant shall submit a signed and notarized Indemnification Agreement to the Office of County Counsel-Risk Management for review and signature by the County.

Proof of recordation of the Indemnification Agreement, as outlined, shall be submitted to the Office of County Counsel-Risk Management

<b>6. PD012(D) - LANDSCAPE PLAN &amp; MAINTENANCE (MPWMD-SFD ONLY)</b>
--

**Responsible Department:** RMA-Planning

**Condition/Mitigation Monitoring Measure:** The site shall be landscaped. Prior to the issuance of building permits, three (3) copies of a landscaping plan shall be submitted to the Director of RMA - Planning . A landscape plan review fee is required for this project. Fees shall be paid at the time of landscape plan submittal. The landscaping plan shall be in sufficient detail to identify the location, species, and size of the proposed landscaping materials and shall include an irrigation plan. The plan shall be accompanied by a nursery or contractor's estimate of the cost of installation of the plan. Before occupancy, landscaping shall be either installed or a certificate of deposit or other form of surety made payable to Monterey County for that cost estimate shall be submitted to the Monterey County RMA - Planning. All landscaped areas and fences shall be continuously maintained by the applicant; all plant material shall be continuously maintained in a litter-free, weed-free, healthy, growing condition. (RMA - Planning)

**Compliance or Monitoring Action to be Performed:** Prior to issuance of building permits, the Owner/Applicant/Licensed Landscape Contractor/Licensed Landscape Architect shall submit landscape plans and contractor's estimate to RMA - Planning for review and approval. Landscaping plans shall include the recommendations from the Forest Management Plan or Biological Survey as applicable. All landscape plans shall be signed and stamped by licensed professional under the following statement, "I certify that this landscaping and irrigation plan complies with all Monterey County landscaping requirements including use of native, drought-tolerant, non-invasive species; limited turf; and low-flow, water conserving irrigation fixtures."

Prior to issuance of building permits, the Owner/Applicant/Licensed Landscape Contractor/Licensed Landscape Architect shall submit one (1) set landscape plans of approved by RMA-Planning, a Maximum Applied Water Allowance (MAWA) calculation, and a completed "Residential Water Release Form and Water Permit Application" to the Monterey Peninsula Water Management District for review and approval.

Prior to issuance of building permits, the Owner/Applicant/Licensed Landscape Contractor/ shall submit an approved water permit from the MPWMD to RMA-Building Services.

Prior to occupancy, the Owner/Applicant/Licensed Landscape Contractor/Licensed Landscape Architect shall ensure that the landscaping shall be either installed or a certificate of deposit or other form of surety made payable to Monterey County for that cost estimate shall be submitted to Monterey County RMA - Planning.

On an on-going basis, all landscaped areas and fences shall be continuously maintained by the Owner/Applicant; all plant material shall be continuously maintained in a litter-free, weed-free, healthy, growing condition.



## 7. PD014(A) - LIGHTING - EXTERIOR LIGHTING PLAN

**Responsible Department:** RMA-Planning

**Condition/Mitigation Monitoring Measure:** All exterior lighting shall be unobtrusive, down-lit, harmonious with the local area, and constructed or located so that only the intended area is illuminated and off-site glare is fully controlled. The lighting source shall be shielded and recessed into the fixture. The applicant shall submit three (3) copies of an exterior lighting plan which shall indicate the location, type, and wattage of all light fixtures and include catalog sheets for each fixture. The lighting shall comply with the requirements of the California Energy Code set forth in California Code of Regulations Title 24 Part 6. The exterior lighting plan shall be subject to approval by the Director of RMA - Planning, prior to the issuance of building permits.  
(RMA - Planning)

**Compliance or Monitoring Action to be Performed:** Prior to the issuance of building permits, the Owner/Applicant shall submit three copies of the lighting plans to RMA - Planning for review and approval. Approved lighting plans shall be incorporated into final building plans.

Prior to final/occupancy, the Owner/Applicant/Contractor shall submit written and photographic evidence demonstrating that the lighting has been installed according to the approved plan.

On an on-going basis, the Owner/Applicant shall ensure that the lighting is installed and maintained in accordance with the approved plan.

## 8. PD041 - HEIGHT VERIFICATION

**Responsible Department:** RMA-Planning

**Condition/Mitigation Monitoring Measure:** The applicant shall have a benchmark placed upon the property and identify the benchmark on the building plans. The benchmark shall remain visible on-site until final building inspection. The applicant shall provide evidence from a licensed civil engineer or surveyor to the Director of RMA - Building Services for review and approval, that the height of the structure(s) from the benchmark is consistent with what was approved on the building permit associated with this project. (RMA - Planning and RMA - Building Services)

**Compliance or Monitoring Action to be Performed:** Prior to the issuance of grading or building permits, the Owner/Applicant shall have a benchmark placed upon the property and identify the benchmark on the building plans. The benchmark shall remain visible onsite until final building inspection.

Prior to the foundation pre-pour inspection, the Owner/Applicant shall provide evidence from a licensed civil engineer or surveyor, to the Director of RMA- Building Services for review and approval, that the height of first finished floor from the benchmark is consistent with what was approved on the building permit.

Prior to the final inspection, the Owner/Applicant/Engineer shall provide evidence from a licensed civil engineer or surveyor, to the Director of RMA- Building Services for review and approval, that the height of the structure(s) from the benchmark is consistent with what was approved on the building permit.

**9. PD050 - RAPTOR/MIGRATORY BIRD NESTING**

**Responsible Department:** RMA-Planning

**Condition/Mitigation Monitoring Measure:** Any tree removal activity that occurs during the typical bird nesting season (February 22-August 1), the County of Monterey shall require that the project applicant retain a County qualified biologist to perform a nest survey in order to determine if any active raptor or migratory bird nests occur within the project site or within 300 feet of proposed tree removal activity. During the typical nesting season, the survey shall be conducted no more than 30 days prior to ground disturbance or tree removal. If nesting birds are found on the project site, an appropriate buffer plan shall be established by the project biologist. (RMA - Planning)

**Compliance or Monitoring Action to be Performed:** No more than 30 days prior to ground disturbance or tree removal, the Owner/Applicant/Tree Removal Contractor shall submit to RMA-Planning a nest survey prepared by a County qualified biologist to determine if any active raptor or migratory bird nests occur within the project site or immediate vicinity.

**10. EROSION CONTROL PLAN:**

**Responsible Department:** Environmental Services

**Condition/Mitigation Monitoring Measure:** The applicant shall submit an erosion control plan in conformance with the requirements of Monterey County Code Chapter 16.12. The erosion control plan shall include a construction entrance, concrete washout, stockpile area(s), material storage area(s), portable sanitation facilities and waste collection area(s), as applicable. (RMA – Environmental Services)

**Compliance or Monitoring Action to be Performed:** Prior to issuance of any grading or building permits, the applicant shall submit an erosion control plan to RMA-Environmental Services for review and approval.

**11. GEOTECHNICAL CERTIFICATION**

**Responsible Department:** Environmental Services

**Condition/Mitigation Monitoring Measure:** The applicant shall provide certification from a licensed practitioner that all development has been constructed in accordance with the recommendations in the project Soil Engineering Investigation. (RMA- Environmental Services)

**Compliance or Monitoring Action to be Performed:** Prior to final inspection, the owner/applicant shall provide RMA-Environmental Services a letter from a licensed practitioner.

**12. GRADING PLAN**

**Responsible Department:** Environmental Services

**Condition/Mitigation Monitoring Measure:** The applicant shall submit a grading plan incorporating the recommendations in the project Soil Engineering Investigation prepared by LandSet Engineers, Inc. The grading plan shall also address the requirements of Monterey County Code Chapter 16.08, and the geotechnical inspection schedule shall be included on the plan. The applicant shall provide certification from the licensed practitioner that the grading plan incorporates their geotechnical recommendations. (RMA-Environmental Services)

**Compliance or Monitoring Action to be Performed:** Prior to issuance of any grading or building permits, the applicant shall submit a grading plan to RMA-Environmental Services for review and approval.

Prior to issuance of any grading or building permits, the applicant shall submit certification from a licensed practitioner that they have reviewed the grading plan for conformance with the geotechnical recommendations.

**13. INSPECTION-DURING ACTIVE CONSTRUCTION**

**Responsible Department:** Environmental Services

**Condition/Mitigation Monitoring Measure:** The applicant shall schedule an inspection with RMA-Environmental Services to inspect drainage device installation, review the maintenance and effectiveness of BMPs installed, and to verify that pollutants of concern are not discharged from the site. At the time of the inspection, the applicant shall provide certification that all necessary geotechnical inspections have been completed to that point. This inspection requirement shall be noted on the Erosion Control Plan. (RMA – Environmental Services)

**Compliance or Monitoring Action to be Performed:** During construction, the applicant shall schedule an inspection with RMA-Environmental Services

**14. INSPECTION-FOLLOWING ACTIVE CONSTRUCTION**

**Responsible Department:** Environmental Services

**Condition/Mitigation Monitoring Measure:** The applicant shall schedule an inspection with RMA-Environmental Services to ensure all disturbed areas have been stabilized and all temporary erosion and sediment control measures that are no longer needed have been removed. This inspection requirement shall be noted on the Erosion Control Plan. (RMA – Environmental Services)

**Compliance or Monitoring Action to be Performed:** Prior to final inspection, the owner/applicant shall schedule an inspection with RMA-Environmental Services.

**15. INSPECTION-PRIOR TO LAND DISTURBANCE**

**Responsible Department:** Environmental Services

**Condition/Mitigation Monitoring Measure:** The applicant shall schedule an inspection with RMA-Environmental Services to ensure all necessary sediment controls are in place and the project is compliant with Monterey County regulations. This inspection requirement shall be noted on the Erosion Control Plan. (RMA – Environmental Services)

**Compliance or Monitoring Action to be Performed:** Prior to commencement of any land disturbance, the owner/applicant shall schedule an inspection with RMA-Environmental Services.

**16. PW0044 - CONSTRUCTION MANAGEMENT PLAN**

**Responsible Department:** RMA-Public Works

**Condition/Mitigation Monitoring Measure:** The applicant shall submit a Construction Management Plan (CMP) to the RMA-Planning Department and the Department of Public Works for review and approval. The CMP shall include measures to minimize traffic impacts during the construction/grading phase of the project and shall provide the following information:

Duration of the construction, hours of operation, an estimate of the number of truck trips that will be generated, truck routes, number of construction workers, parking areas for both equipment and workers, and locations of truck staging areas. Approved measures included in the CMP shall be implemented by the applicant during the Construction/grading phase of the project.

**Compliance or Monitoring Action to be Performed:**

1. Prior to issuance of the Grading Permit or Building Permit Owner/Applicant/Contractor shall prepare a CMP and shall submit the CMP to the RMA-Planning Department and the Department of Public Works for review and approval.
2. On-going through construction phases Owner/Applicant/Contractor shall implement the approved measures during the construction/grading phase of the project.

**17. WR008 - STORMWATER DETENTION**

**Responsible Department:** Environmental Services

**Condition/Mitigation Monitoring Measure:** The applicant shall provide a drainage plan, prepared by a registered civil engineer, addressing on-site and off-site impacts. The plan shall include detention facilities to mitigate the impact of impervious surface stormwater runoff. Supporting calculations and construction details shall also be provided. Drainage improvements shall be constructed in accordance with plans approved by the Water Resources Agency. (Water Resources Agency)

**Compliance or Monitoring Action to be Performed:** Prior to issuance of any construction permit, the owner/applicant shall submit a drainage plan with the construction permit application. The Building Services Department will route a plan set to the Water Resources Agency for review and approval.

**18. WR010 - COMPLETION CERTIFICATION**

**Responsible Department:** Environmental Services

**Condition/Mitigation Monitoring Measure:** The applicant shall provide certification from a registered civil engineer or licensed contractor that stormwater detention facilities have been constructed in accordance with the approved drainage plan. (Water Resources Agency)

**Compliance or Monitoring Action to be Performed:** Prior to final inspection, the owner/applicant shall submit a letter to the Water Resources Agency prepared by a registered civil engineer or licensed contractor.



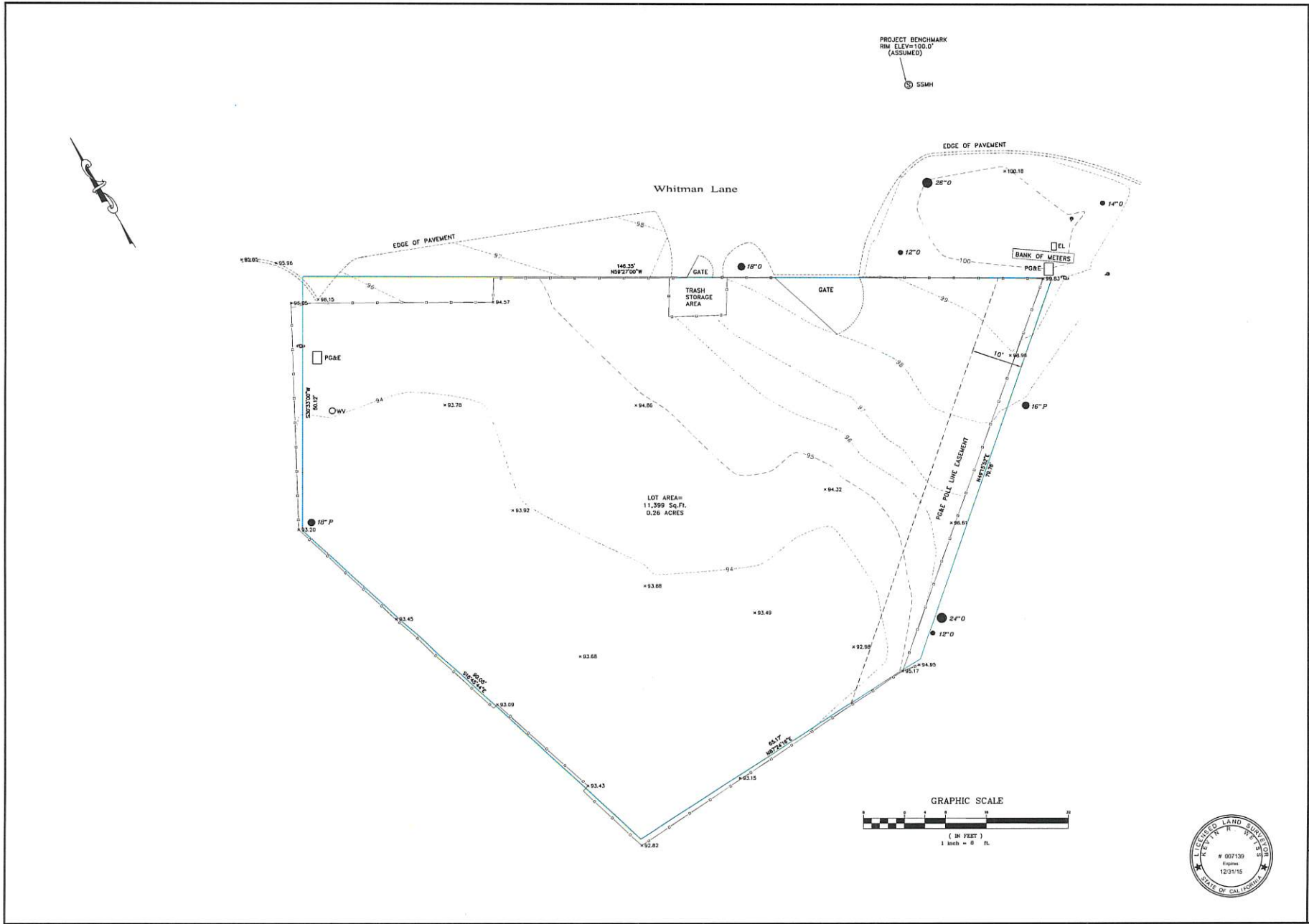

LOT AREA = 11,399 Sq. Ft. 0.26 ACRES

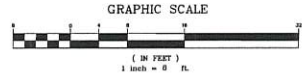

Baseline Consulting  
 13720 Nimitz Blvd  
 Castroville, California 95012  
 831-632-0956

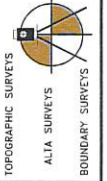

TOPOGRAPHIC SURVEYS  
 ALTA SURVEYS  
 BOUNDARY SURVEYS

DRAWN BY: MS  
 APPROVED BY: HEW  
 REVISION: 1/8"=1"  
 SCALE: 06-26-2015  
 DATE:

**SITE PLAN**  
 APN 008-401-010  
 3213 Whitman Lane, Pebble Beach, Ca  
 prepared for:  
 Mr. & Mrs. Scott Raven

SHEET 1  
 OF  
 1 SHEETS







THIS SET OF ARCHITECTURAL DRAWINGS IS THE PROPERTY OF ERIC MILLER ARCHITECTS, INC. AND IS TO BE USED ONLY FOR THE PROJECT AND SITE SPECIFICALLY IDENTIFIED HEREON. NO PART OF THIS SET OF ARCHITECTURAL DRAWINGS IS TO BE REPRODUCED OR TRANSMITTED IN ANY FORM OR BY ANY MEANS, ELECTRONIC OR MECHANICAL, INCLUDING PHOTOCOPYING, RECORDING, OR BY ANY INFORMATION STORAGE AND RETRIEVAL SYSTEM, WITHOUT THE WRITTEN PERMISSION OF ERIC MILLER ARCHITECTS, INC. CONSULTANT SHALL ASSUME LIABILITY FOR ANY ERRORS OR OMISSIONS OF THESE ARCHITECTS.

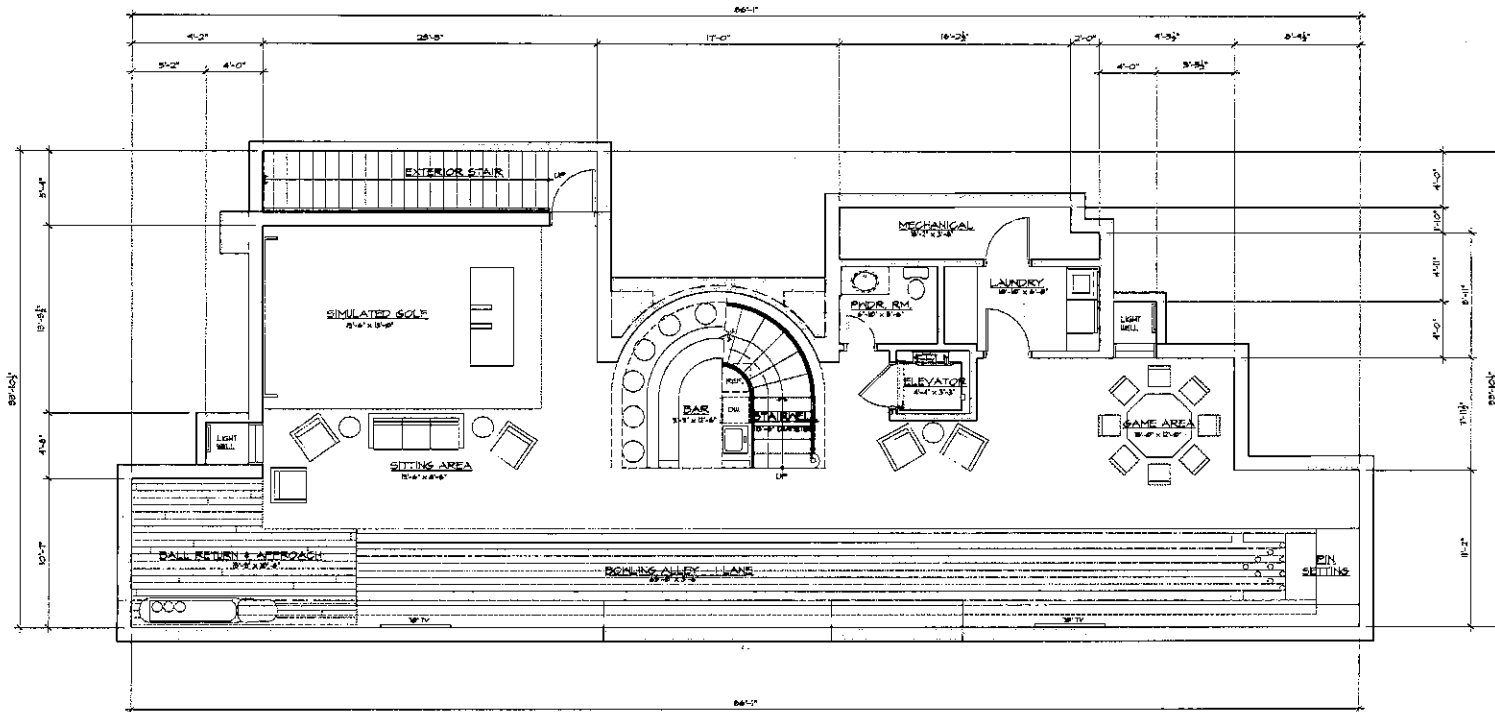

**BASEMENT FLOOR PLAN**  
 SCALE: 1/4" = 1'-0"

REVISION	No.

ARCHITECT  
**ERIC MILLER ARCHITECTS, INC.**  
 211 HOFFMAN AVENUE MONTEREY, CA 93940  
 PHONE (831) 326-8142 • FAX (831) 375-7546 • WEB: www.ericmillerarchitects.com

**BASEMENT W/ VARIANCE**  
 JOB NAME:  
**Raven Residence**  
 9319 Millman Lane  
 Pebble Beach, CA  
 A.P.N. 008-401-010

DATE: 2/7/19  
 SCALE: 1/4" = 1'-0"  
 DRAWN: C.B.  
 JOB NUMBER: 19-17

A-2.0

SHEET 09

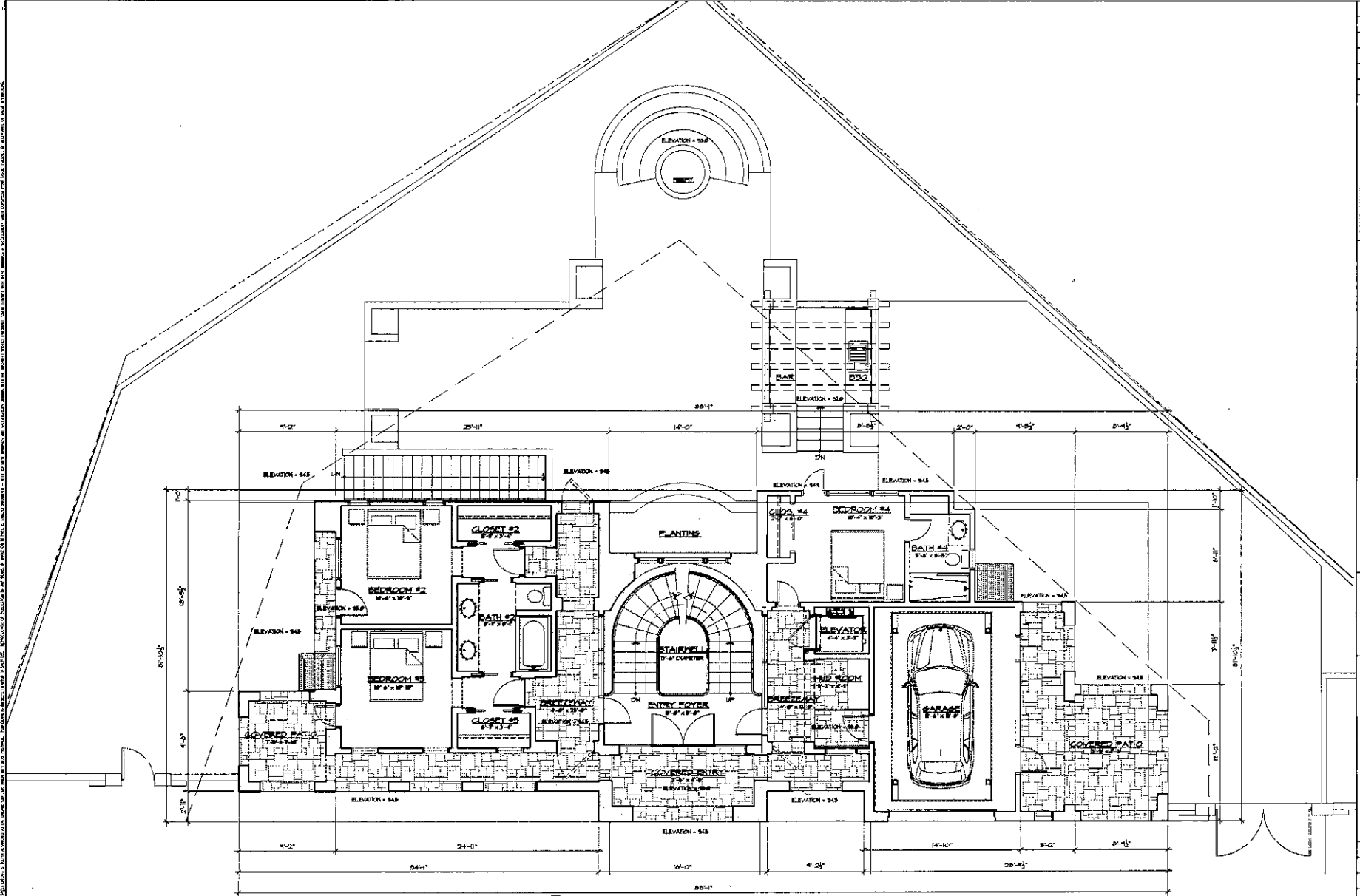

**FIRST FLOOR PLAN**  
SCALE: 1/4" = 1'-0"

REVISION	No.

CONSULTANT:

ARCHITECT  
**ERIC MILLER ARCHITECTS, INC.**  
 211 HOFFMAN AVENUE MONTEREY, CA 93940  
 PHONE: (831) 238-1100 FAX: (831) 238-1100  
 WWW.ERICMILLERARCHITECTS.COM

FIRST FLOOR VARIANCE

PROJECT NAME:  
**Raven Residence**  
 3315 Millerton Lane  
 Pebble Beach, CA  
 A.P.N. 003-401-010

DATE:	2/14/21
SCALE:	1/4" = 1'-0"
DRAWN:	EMK
JOB NUMBER:	15117

**A-2.1**  
SHEET OF 17



ALL WORK SHALL BE IN ACCORDANCE WITH THE CALIFORNIA BUILDING CODE, 2019 EDITION, UNLESS OTHERWISE SPECIFIED. THE ARCHITECT SHALL BE RESPONSIBLE FOR OBTAINING ALL NECESSARY PERMITS AND APPROVALS FROM THE LOCAL JURISDICTION. THE ARCHITECT SHALL BE RESPONSIBLE FOR OBTAINING ALL NECESSARY PERMITS AND APPROVALS FROM THE LOCAL JURISDICTION. THE ARCHITECT SHALL BE RESPONSIBLE FOR OBTAINING ALL NECESSARY PERMITS AND APPROVALS FROM THE LOCAL JURISDICTION.

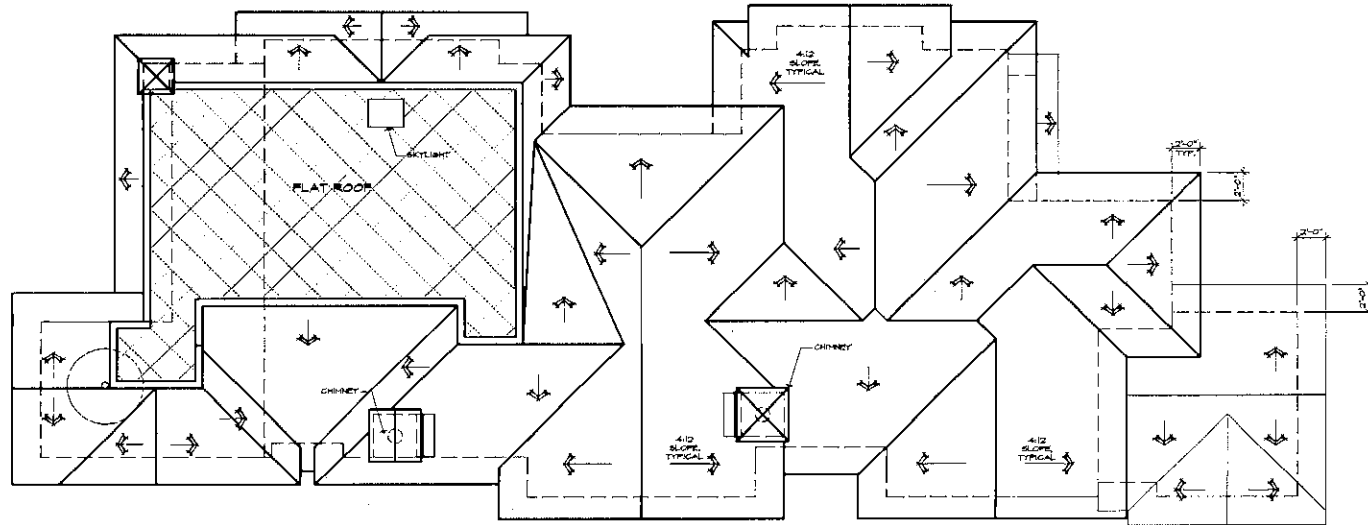

**ROOF PLAN**  
 SCALE: 1/4" = 1'-0"

REVISION	No.

CONSULTANT:



**ERIC MILLER ARCHITECTS, INC.**  
 211 HOFFMAN AVENUE MONTEREY, CA 93940  
 PHONE: 831.372.8116 FAX: 831.372.8167 WEB: www.ericmillerarch.com

ARCHITECT

**ROOF PLAN**  
 JOB NAME: **Raven Residence**  
 5415 Millerton Lane  
 Pacific Beach, CA  
 A.P.N. C02-401-010

DATE: 02/19/19  
 SCALE: 1/4" = 1'-0"  
 DRAWN: DMR  
 JOB NUMBER: 1917

**A-2.3**  
 SHEET OF

ALL WORK SHALL BE IN ACCORDANCE WITH THE CALIFORNIA BUILDING CODE (CBC) AND ALL APPLICABLE LOCAL ORDINANCES. THE DESIGNER SHALL BE RESPONSIBLE FOR OBTAINING ALL NECESSARY PERMITS AND APPROVALS FROM THE LOCAL JURISDICTION. THE DESIGNER SHALL BE RESPONSIBLE FOR OBTAINING ALL NECESSARY PERMITS AND APPROVALS FROM THE LOCAL JURISDICTION. THE DESIGNER SHALL BE RESPONSIBLE FOR OBTAINING ALL NECESSARY PERMITS AND APPROVALS FROM THE LOCAL JURISDICTION.

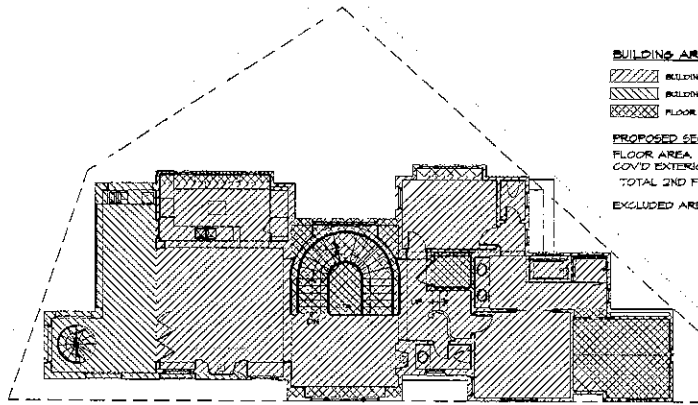

**BUILDING AREA INDEX**

- BUILDING FLOOR AREA
- BUILDING SITE COVERAGE
- FLOOR AREA (EXCLUDED)

**PROPOSED SECOND FLOOR**

- FLOOR AREA ..... 1,366 S.F.
- COVD'D EXTERIOR ..... 306 S.F.
- TOTAL 2ND FLR. .... 1,642 S.F.
- EXCLUDED AREA ..... 473 S.F.



**SECOND FLOOR AREA DIAGRAM**  
SCALE: 1/8" = 1'-0"

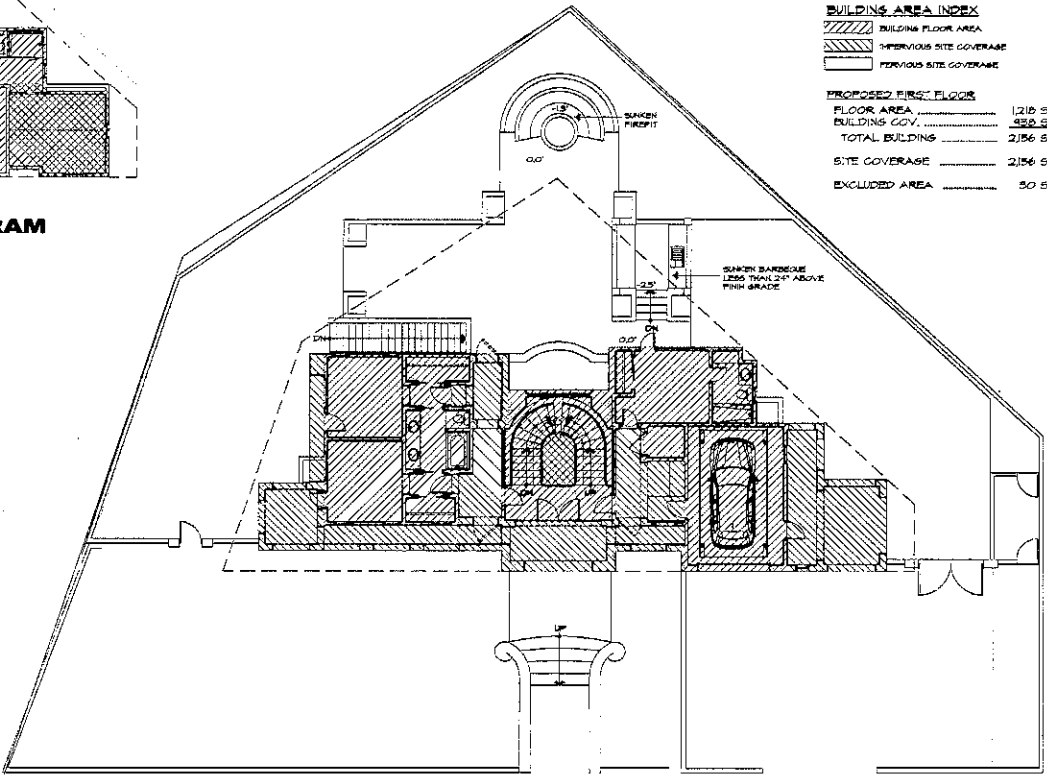

**BUILDING AREA INDEX**

- BUILDING FLOOR AREA
- PERVIOUS SITE COVERAGE
- PREVIOUS SITE COVERAGE

**PROPOSED FIRST FLOOR**

- FLOOR AREA ..... 1,216 S.F.
- BUILDING COV. .... 488 S.F.
- TOTAL BUILDING ..... 2,156 S.F.
- SITE COVERAGE ..... 2,156 S.F.
- EXCLUDED AREA ..... 30 S.F.



**FIRST FLOOR AREA DIAGRAM**  
SCALE: 1/8" = 1'-0"

REVISION	No.

CONSULTANT:



**ERIC MILLER ARCHITECTS, INC.**  
 211 HOTFMAN AVENUE MONTEREY, CA 93940  
 PHONE (831) 726-0416 • FAX (831) 726-0416 • WEB: www.ericmillerarchitects.com

ARCHITECT

FLOOR AREA DIAGRAM

FOR NAME: **Raven Residence**  
 3213 Milliken Lane  
 Piedale Beach, CA  
 A.P.N. COB-401-010

DATE: 2/14/19  
 SCALE: 1/8" = 1'-0"  
 DRAWN: DRW  
 JOB NUMBER: 1917

**A-2.4**  
 SHEET OF





**FRONT ELEVATION VIEW FROM WHITMAN LANE**

ALL CITY OF SAN FRANCISCO AND SAN JOAQUIN COUNTY RECORDS TO BE OPENED TO THE PUBLIC BY THE ARCHITECT. THE ARCHITECT IS NOT RESPONSIBLE FOR THE ACCURACY OF THE INFORMATION PROVIDED. THE ARCHITECT IS NOT RESPONSIBLE FOR THE ACCURACY OF THE INFORMATION PROVIDED. THE ARCHITECT IS NOT RESPONSIBLE FOR THE ACCURACY OF THE INFORMATION PROVIDED.

REVISION	No.

CONSULTANT:

ARCHITECT  
**ERIC MILLER ARCHITECTS, INC.**  
 211 HOFFMAN AVENUE MONTEREY, CA 93940  
 PHONE (831) 372-0110 • FAX (831) 372-1446 • [www.ericmillerarchitects.com](http://www.ericmillerarchitects.com)

RENDERING  
 ART NAME: Raven Residence  
 5217 Millman Lane  
 Pebble Beach, CA  
 A.P.N. 008-401-010

DATE: 2/14/19  
 SCALE: N.T.S.  
 DRAWN: C.J.H.  
 JOB NUMBER: 19171

**A-7.1**  
 SHEET OF







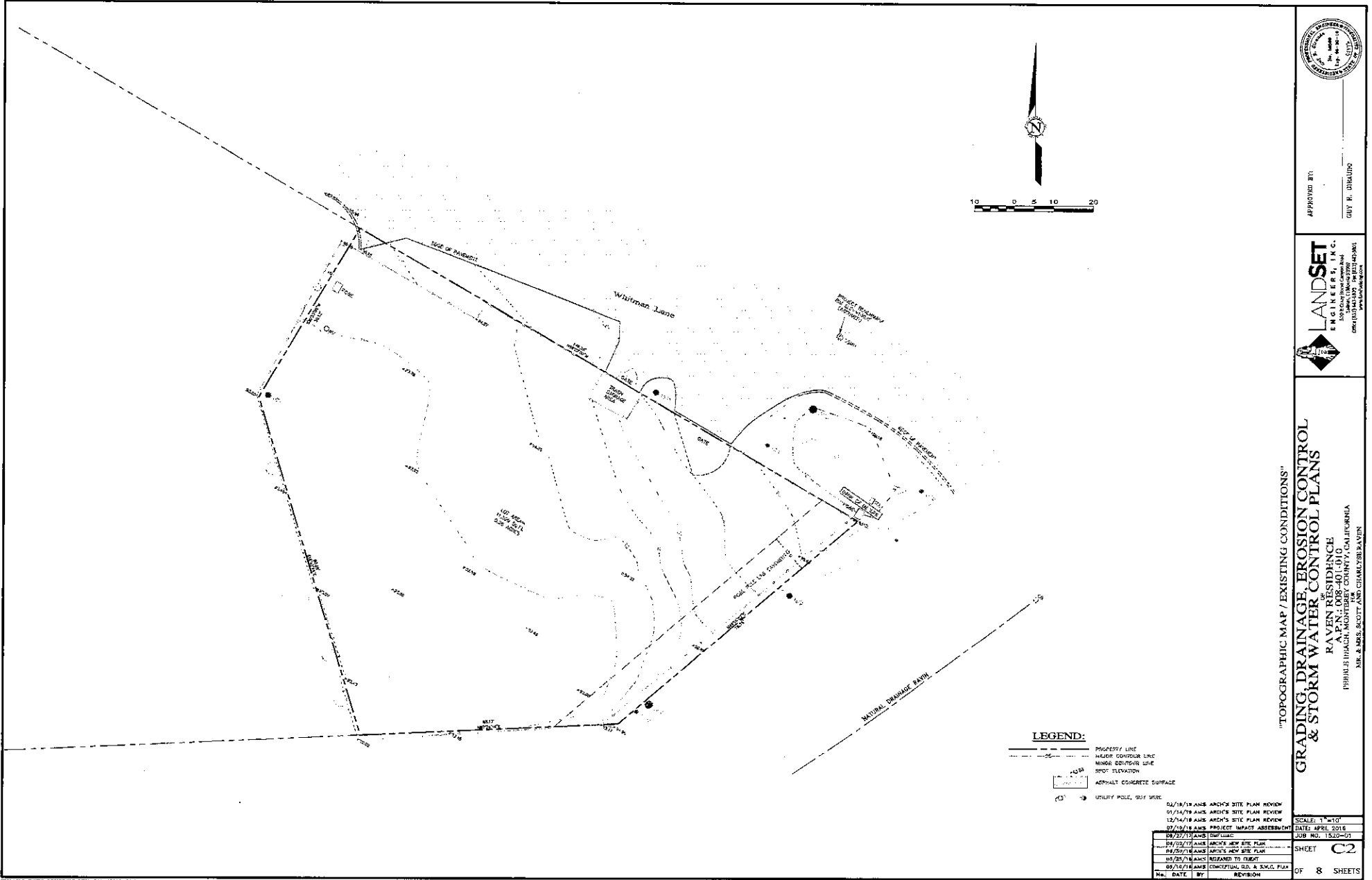

**LEGEND:**

- PROPERTY LINE
- MAJOR CONTOUR LINE
- MINOR CONTOUR LINE
- SPOT ELEVATION
- ▭ ASPHALT CONCRETE SURFACE
- UTILITY POLE, 20FT SPAC.

**"TOPOGRAPHIC MAP / EXISTING CONDITIONS"**  
**GRADING, DRAINAGE, EROSION CONTROL**  
**& STORM WATER CONTROL PLANS**

**RAVEN RESIDENCE**  
 10000 WILLOW CREEK DRIVE  
 PUEBLO BLVD. TRACT, MONTGOMERY COUNTY, CALIFORNIA  
 MR. & MRS. SCOTT AND CHELSEA BEAVER



APPROVED BY:  
 GUY H. GILGOUNG



02/18/18 AME ARCH'S SITE PLAN REVIEW	02/18/18 AME PROJECT IMPACT ASSESSMENT	DATE: APRIL 2016
01/14/18 AME ARCH'S SITE PLAN REVIEW		SCALE: 1"=10'
12/24/18 AME ARCH'S SITE PLAN REVIEW		JOB NO. 1510-01
08/27/17 AME CIVIL/ME		DATE: APRIL 2016
04/03/17 AME ARCH'S NEW SITE PLAN		SHEET
04/25/16 AME ARCH'S NEW SITE PLAN		02
04/25/16 AME REFERRED TO CLIENT		OF 8 SHEETS
02/16/16 AME CONSTRUCTION & S.M.C. PLAN		
NO. DATE BY REVISION		

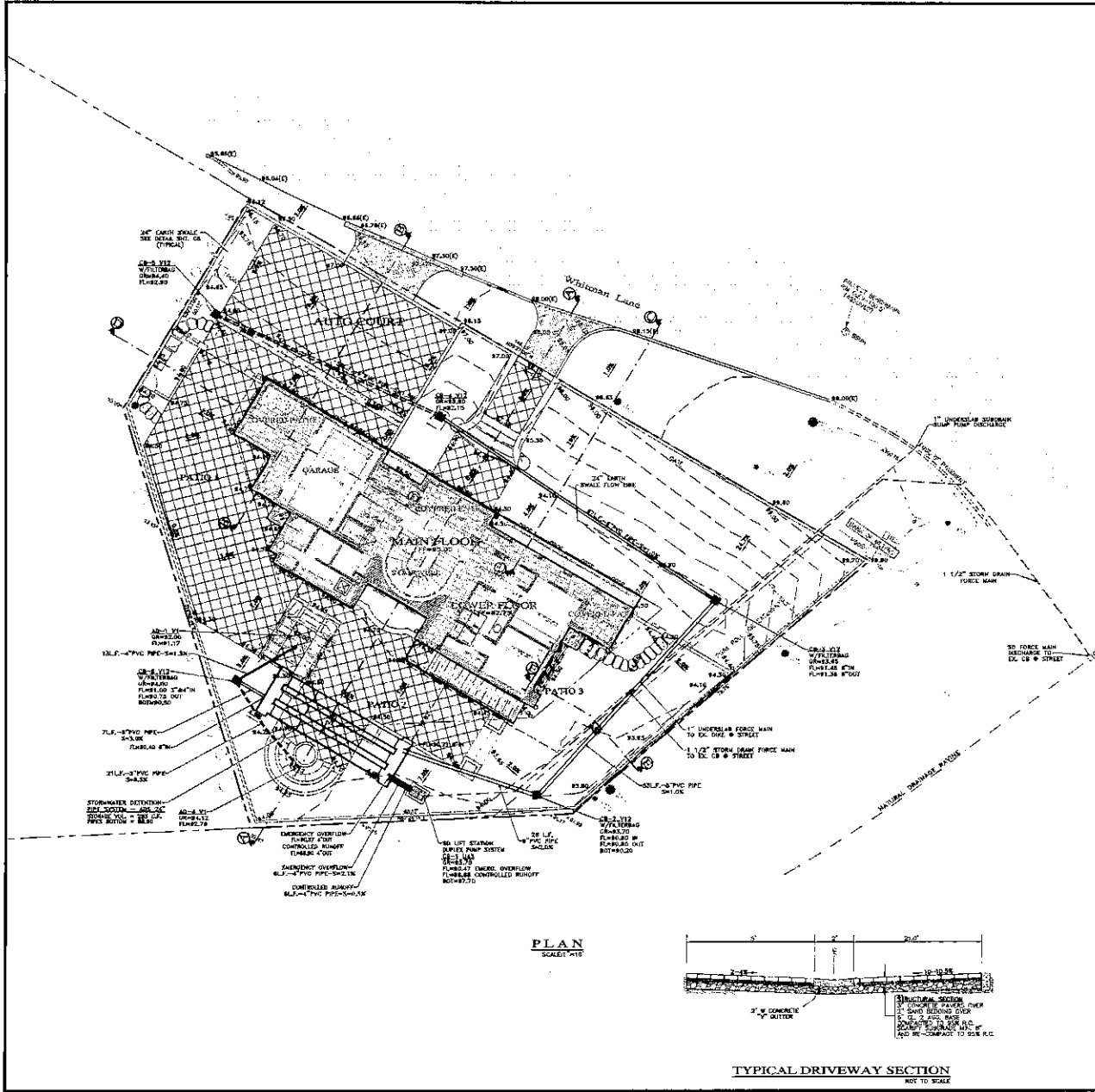

PLAN  
SCALE: 1/8" = 1'-0"

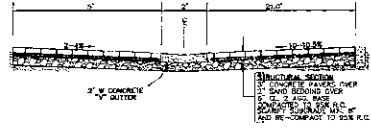

TYPICAL DRIVEWAY SECTION  
NOT TO SCALE

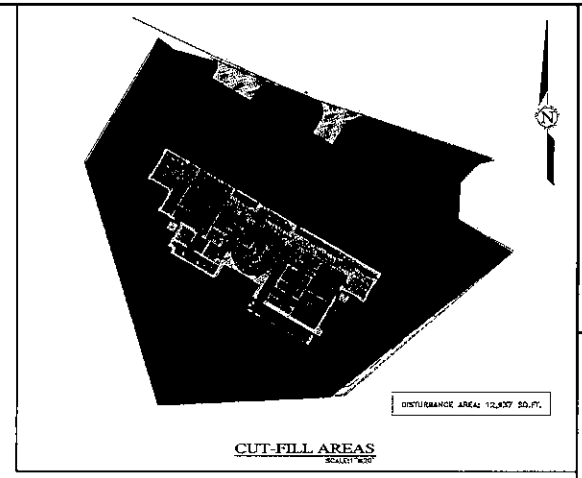

Cut/Fill Summary

Name	Cut Section	Fill Section	Area	Cut	Fill	Net
1320-001 2280	1.068	12837.22	Sq. Ft.	1360.42 Cu. Yd.	93.14 Cu. Yd.	1267.28 Cu. Yd. = 62537
Total				12837.22 Sq. Ft.	1360.42 Cu. Yd.	93.14 Cu. Yd. = 1267.28 Cu. Yd. = 62537

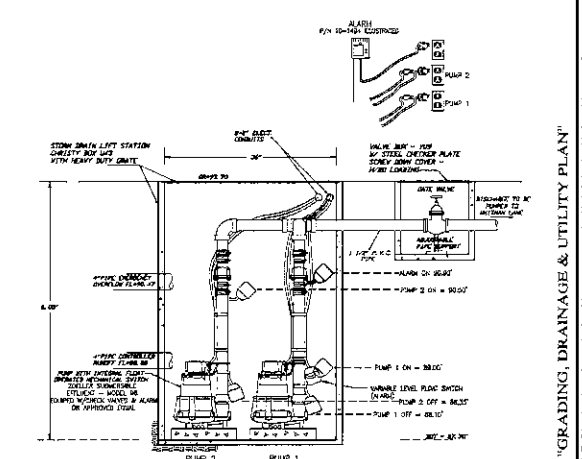

STORM DRAIN LIFT STATION

DESIGN CRITERIA:  
 PUMP ELEVATION = 87.70ft  
 STREET ELEVATION = 89.30  
 LENGTH OF DISCHARGE = 178 LF.  
 Q = 89 GPM

NO.	DATE	BY	REVISION
02/19/18	AMS	ARCH'S SITE PLAN REVIEW	
01/14/18	AMS	ARCH'S SITE PLAN REVIEW	
12/14/18	AMS	ARCH'S SITE PLAN REVIEW	
07/15/18	AMS	PROJECT IMPACT ASSESSMENT	
09/27/17	AMS	SHAULIAC	
04/05/17	AMS	ARCH'S NEW SITE PLAN	
04/05/18	AMS	ARCH'S NEW SITE PLAN	
05/28/18	AMS	RELEASED TO CLIENT	
05/15/18	AMS	CONCEPTUAL G.S. & S.W.G. PLAN	

APPROVED BY: [Signature]  
 CITY CLERK: [Signature]  
**LANDSET ENGINEERS, INC.**  
 1000 S. GARDEN AVENUE, SUITE 100  
 ANAHEIM, CALIFORNIA 92805  
 (714) 933-1100  
 www.landset.com

"GRADING, DRAINAGE & UTILITY PLAN"  
**GRADING, DRAINAGE, EROSION CONTROL & STORM WATER CONTROL PLANS**  
 KAYEN RESIDENCE  
 1415 N. AMES ROAD  
 PERRIS, CA 92570  
 MR. & MRS. SCOTT AND CHARLENE RAVEN

SCALE: AS SHOWN  
 DATE: APRIL 2018  
 JOB NO.: 1520-01  
 SHEET **C3**  
 OF 8 SHEETS

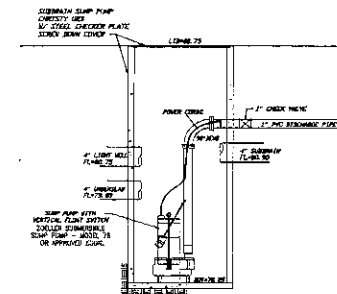
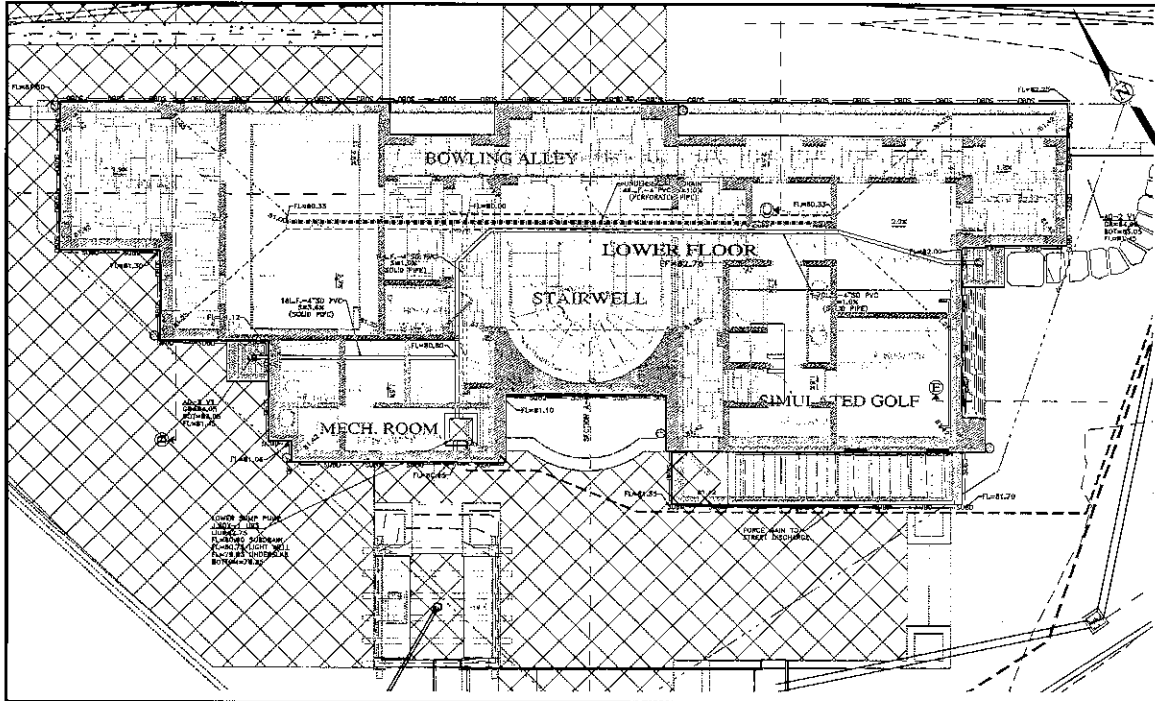

**DESIGN CRITERIA:**  
 PUMP ELEVATION = 78.25±  
 STREET ELEVATION = 89.20  
 LENGTH OF DISCHARGE = 15.4 L.F.  
 Q<sub>max</sub> = 5 G.P.M.

**LOWER SUMP PUMP**  
NOT TO SCALE

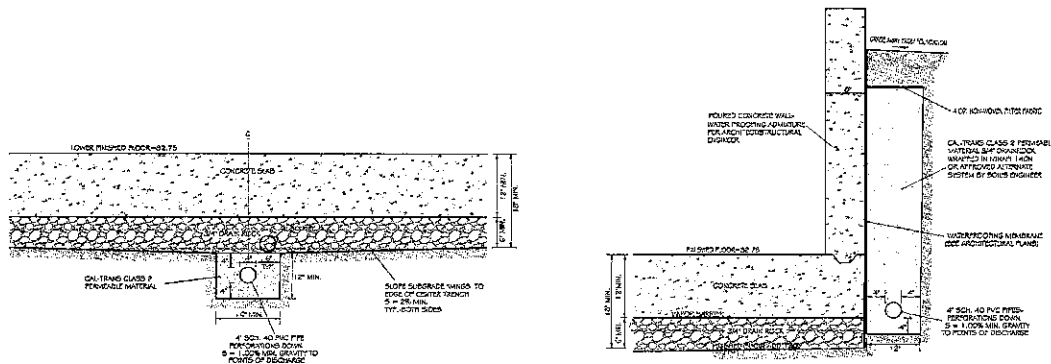

"LOWER FLOOR PLAN - UNDERSLAB DRAIN"

**GRADING, DRAINAGE, EROSION CONTROL & STORM WATER CONTROL PLANS**

R. AVEN RESIDENCE  
A. P. N. : 008-401410  
PUEBLO BEACH, MONTEREY COUNTY, CALIFORNIA  
MR. & MRS. SCOTT AND CHARLOTTE RAVEN

APPROVED BY: GUY M. QUINADO

**LANDSET ENGINEERS, INC.**  
12500 CALIFORNIA AVENUE  
CITY, CALIFORNIA 94622  
TEL: (415) 961-1661  
WWW.LANDSET.COM

02/16/18 AMS ARCHV'S SITE PLAN REVIEW  
 01/14/18 AMS ARCHV'S SITE PLAN REVIEW  
 02/14/18 AMS ARCHV'S SITE PLAN REVIEW  
 07/19/18 AMS PROJECT IMPACT ASSESSMENT  
 09/27/17 AMS EMPHASIS  
 04/27/17 AMS ARCHV'S NEW SITE PLAN  
 09/29/16 AMS ARCHV'S NEW SITE PLAN  
 03/25/16 AMS DELIVERED TO CLIENT  
 05/19/15 AMS CONCEPTUAL G.D. & S.D. PLAN

SCALE: AS SHOWN  
 DATE: APRIL 2016  
 JOB NO.: 1520-01

SHEET **C4** OF 8 SHEETS

REV. DATE BY REVISION

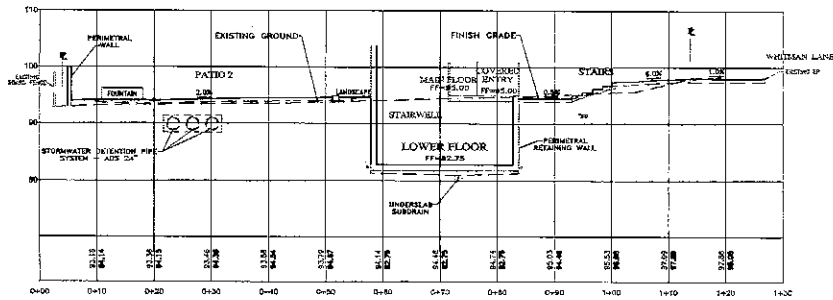

SECTION A-A  
SCALE 1"=10' H&V

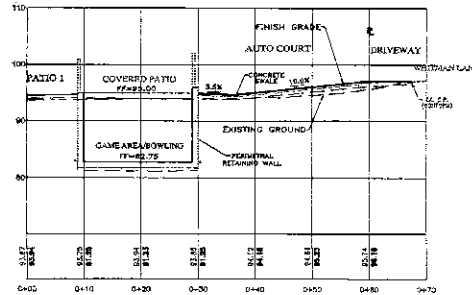

SECTION B-B  
SCALE 1"=10' H&V

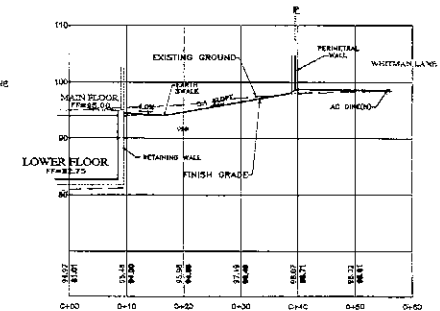

SECTION C-C  
SCALE 1"=10' H&V

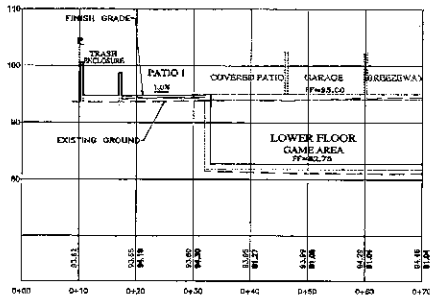

SECTION D-D  
SCALE 1"=10' H&V

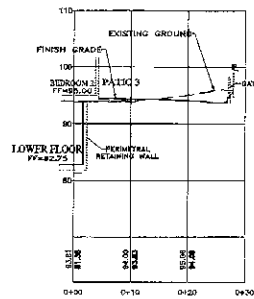

SECTION E-E  
SCALE 1"=10' H&V



APPROVED BY:  
CITY OF OAKLAND



"GRADING SECTIONS"  
GRADING, DRAINAGE, EROSION CONTROL  
& STORM WATER CONTROL PLANS  
FOR  
RAVEN RESIDENCE  
A.P.N.: 008-401-010  
PERHILL HILLS, MONTEREY COUNTY, CALIFORNIA  
MR. & MRS. SCOTT AND CHARLESE RAVEN

02/19/18	AMC ARCH'S SITE PLAN REVIEW	01/14/18	AMC ARCH'S SITE PLAN REVIEW
12/14/16	AMC ARCH'S SITE PLAN REVIEW	12/14/16	AMC ARCH'S SITE PLAN REVIEW
07/16/16	AMC PROJECT IMPACT ASSESSMENT	07/16/16	AMC PROJECT IMPACT ASSESSMENT
09/27/17	AMC DRAFTING	09/27/17	AMC DRAFTING
10/27/17	AMC ARCH'S NEW SITE PLAN	10/27/17	AMC ARCH'S NEW SITE PLAN
08/20/18	AMC ARCH'S NEW SITE PLAN	08/20/18	AMC ARCH'S NEW SITE PLAN
05/25/18	AMC RELEASED TO CLIENT	05/25/18	AMC RELEASED TO CLIENT
05/10/18	AMC CONCEPTUAL, G.S. & SW/SI PLAN	05/10/18	AMC CONCEPTUAL, G.S. & SW/SI PLAN
REV	DATE	BY	REVISION

SCALE: 1"=10' H&V  
SHEET 8 OF 8 SHEETS



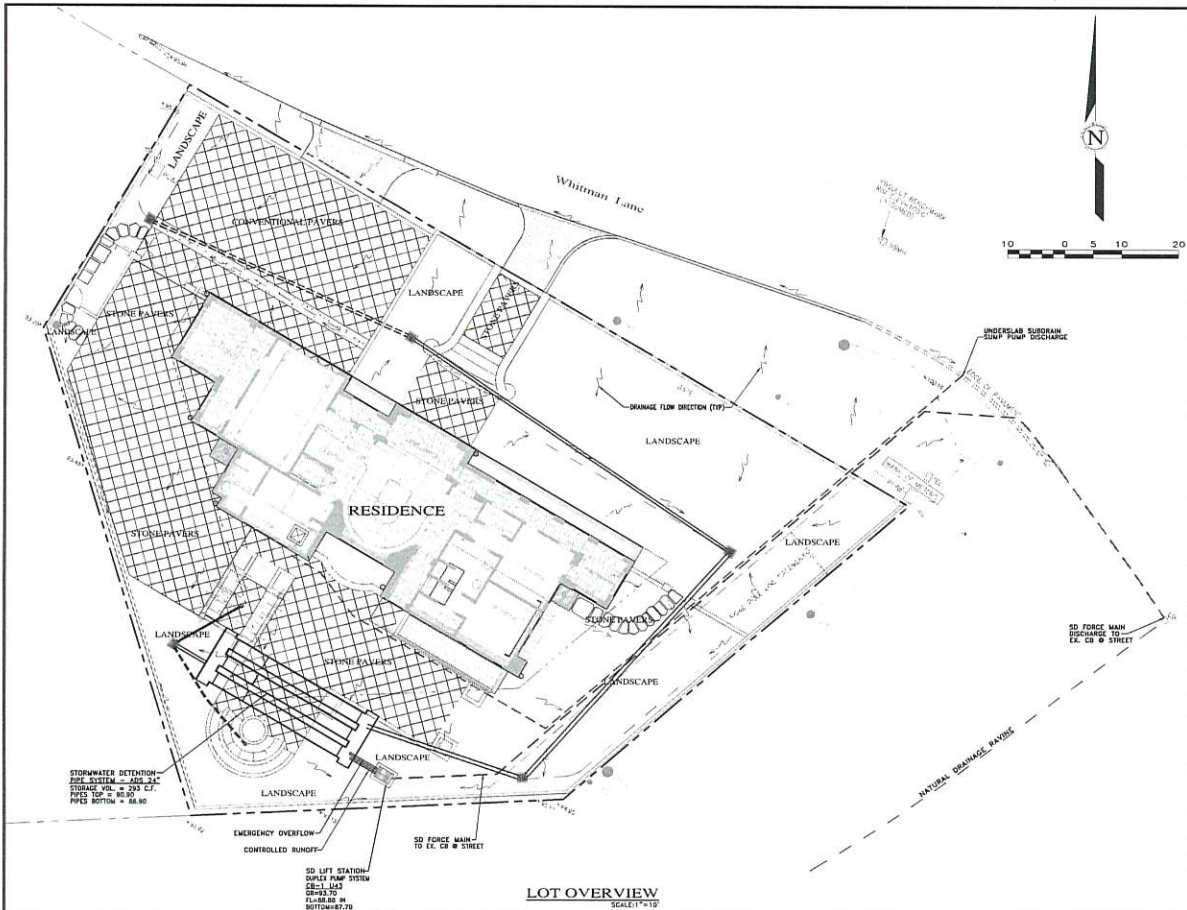

TOTAL LOT AREA 11,399 sq.ft. = 0.2617 Ac.		IMPERVIOUS POST-DEVELOPED AREA 5,598 sq.ft.	
PERVIOUS POST-DEVELOPED AREA 5,357 SQ.FT.		BUILDING - ROOF 2,130 SQ.FT.	
IMPERVIOUS POST-DEVELOPED AREA 5,598 SQ.FT.		AUTOCOURT - PAVERS 1,152 SQ.FT.	
		PATIOS - CONCRETE 2,316 SQ.FT.	

DRAIN AREA	CONTRIBUTING AREA (ACRES)	MEASURED AREA (SQ. FT.)	FLOW DISTANCE (FEET)	SOIL TYPE (S)	SLOPE (PERCENT)	PIPE SIZE (INCH)	PIPE MATERIAL	PIPE COVER (INCH)	INVERT ELEVATION (FEET)	OUTLET ELEVATION (FEET)	FLOW RATE (MGD)
1	0.00	0.00	0.00	1	0.00	12	SMC	18	100.00	99.50	0.00
2	0.00	0.00	0.00	1	0.00	12	SMC	18	100.00	99.50	0.00
3	0.00	0.00	0.00	1	0.00	12	SMC	18	100.00	99.50	0.00
4	0.00	0.00	0.00	1	0.00	12	SMC	18	100.00	99.50	0.00
5	0.00	0.00	0.00	1	0.00	12	SMC	18	100.00	99.50	0.00
6	0.00	0.00	0.00	1	0.00	12	SMC	18	100.00	99.50	0.00
7	0.00	0.00	0.00	1	0.00	12	SMC	18	100.00	99.50	0.00
8	0.00	0.00	0.00	1	0.00	12	SMC	18	100.00	99.50	0.00
9	0.00	0.00	0.00	1	0.00	12	SMC	18	100.00	99.50	0.00
10	0.00	0.00	0.00	1	0.00	12	SMC	18	100.00	99.50	0.00
11	0.00	0.00	0.00	1	0.00	12	SMC	18	100.00	99.50	0.00
12	0.00	0.00	0.00	1	0.00	12	SMC	18	100.00	99.50	0.00
13	0.00	0.00	0.00	1	0.00	12	SMC	18	100.00	99.50	0.00
14	0.00	0.00	0.00	1	0.00	12	SMC	18	100.00	99.50	0.00
15	0.00	0.00	0.00	1	0.00	12	SMC	18	100.00	99.50	0.00
16	0.00	0.00	0.00	1	0.00	12	SMC	18	100.00	99.50	0.00
17	0.00	0.00	0.00	1	0.00	12	SMC	18	100.00	99.50	0.00
18	0.00	0.00	0.00	1	0.00	12	SMC	18	100.00	99.50	0.00
19	0.00	0.00	0.00	1	0.00	12	SMC	18	100.00	99.50	0.00
20	0.00	0.00	0.00	1	0.00	12	SMC	18	100.00	99.50	0.00
21	0.00	0.00	0.00	1	0.00	12	SMC	18	100.00	99.50	0.00
22	0.00	0.00	0.00	1	0.00	12	SMC	18	100.00	99.50	0.00
23	0.00	0.00	0.00	1	0.00	12	SMC	18	100.00	99.50	0.00
24	0.00	0.00	0.00	1	0.00	12	SMC	18	100.00	99.50	0.00
25	0.00	0.00	0.00	1	0.00	12	SMC	18	100.00	99.50	0.00
26	0.00	0.00	0.00	1	0.00	12	SMC	18	100.00	99.50	0.00
27	0.00	0.00	0.00	1	0.00	12	SMC	18	100.00	99.50	0.00
28	0.00	0.00	0.00	1	0.00	12	SMC	18	100.00	99.50	0.00
29	0.00	0.00	0.00	1	0.00	12	SMC	18	100.00	99.50	0.00
30	0.00	0.00	0.00	1	0.00	12	SMC	18	100.00	99.50	0.00
31	0.00	0.00	0.00	1	0.00	12	SMC	18	100.00	99.50	0.00
32	0.00	0.00	0.00	1	0.00	12	SMC	18	100.00	99.50	0.00
33	0.00	0.00	0.00	1	0.00	12	SMC	18	100.00	99.50	0.00
34	0.00	0.00	0.00	1	0.00	12	SMC	18	100.00	99.50	0.00
35	0.00	0.00	0.00	1	0.00	12	SMC	18	100.00	99.50	0.00
36	0.00	0.00	0.00	1	0.00	12	SMC	18	100.00	99.50	0.00
37	0.00	0.00	0.00	1	0.00	12	SMC	18	100.00	99.50	0.00
38	0.00	0.00	0.00	1	0.00	12	SMC	18	100.00	99.50	0.00
39	0.00	0.00	0.00	1	0.00	12	SMC	18	100.00	99.50	0.00
40	0.00	0.00	0.00	1	0.00	12	SMC	18	100.00	99.50	0.00
41	0.00	0.00	0.00	1	0.00	12	SMC	18	100.00	99.50	0.00
42	0.00	0.00	0.00	1	0.00	12	SMC	18	100.00	99.50	0.00
43	0.00	0.00	0.00	1	0.00	12	SMC	18	100.00	99.50	0.00
44	0.00	0.00	0.00	1	0.00	12	SMC	18	100.00	99.50	0.00
45	0.00	0.00	0.00	1	0.00	12	SMC	18	100.00	99.50	0.00
46	0.00	0.00	0.00	1	0.00	12	SMC	18	100.00	99.50	0.00
47	0.00	0.00	0.00	1	0.00	12	SMC	18	100.00	99.50	0.00
48	0.00	0.00	0.00	1	0.00	12	SMC	18	100.00	99.50	0.00
49	0.00	0.00	0.00	1	0.00	12	SMC	18	100.00	99.50	0.00
50	0.00	0.00	0.00	1	0.00	12	SMC	18	100.00	99.50	0.00
51	0.00	0.00	0.00	1	0.00	12	SMC	18	100.00	99.50	0.00
52	0.00	0.00	0.00	1	0.00	12	SMC	18	100.00	99.50	0.00
53	0.00	0.00	0.00	1	0.00	12	SMC	18	100.00	99.50	0.00
54	0.00	0.00	0.00	1	0.00	12	SMC	18	100.00	99.50	0.00
55	0.00	0.00	0.00	1	0.00	12	SMC	18	100.00	99.50	0.00
56	0.00	0.00	0.00	1	0.00	12	SMC	18	100.00	99.50	0.00
57	0.00	0.00	0.00	1	0.00	12	SMC	18	100.00	99.50	0.00
58	0.00	0.00	0.00	1	0.00	12	SMC	18	100.00	99.50	0.00
59	0.00	0.00	0.00	1	0.00	12	SMC	18	100.00	99.50	0.00
60	0.00	0.00	0.00	1	0.00	12	SMC	18	100.00	99.50	0.00
61	0.00	0.00	0.00	1	0.00	12	SMC	18	100.00	99.50	0.00
62	0.00	0.00	0.00	1	0.00	12	SMC	18	100.00	99.50	0.00
63	0.00	0.00	0.00	1	0.00	12	SMC	18	100.00	99.50	0.00
64	0.00	0.00	0.00	1	0.00	12	SMC	18	100.00	99.50	0.00
65	0.00	0.00	0.00	1	0.00	12	SMC	18	100.00	99.50	0.00
66	0.00	0.00	0.00	1	0.00	12	SMC	18	100.00	99.50	0.00
67	0.00	0.00	0.00	1	0.00	12	SMC	18	100.00	99.50	0.00
68	0.00	0.00	0.00	1	0.00	12	SMC	18	100.00	99.50	0.00
69	0.00	0.00	0.00	1	0.00	12	SMC	18	100.00	99.50	0.00
70	0.00	0.00	0.00	1	0.00	12	SMC	18	100.00	99.50	0.00
71	0.00	0.00	0.00	1	0.00	12	SMC	18	100.00	99.50	0.00
72	0.00	0.00	0.00	1	0.00	12	SMC	18	100.00	99.50	0.00
73	0.00	0.00	0.00	1	0.00	12	SMC	18	100.00	99.50	0.00
74	0.00	0.00	0.00	1	0.00	12	SMC	18	100.00	99.50	0.00
75	0.00	0.00	0.00	1	0.00	12	SMC	18	100.00	99.50	0.00
76	0.00	0.00	0.00	1	0.00	12	SMC	18	100.00	99.50	0.00
77	0.00	0.00	0.00	1	0.00	12	SMC	18	100.00	99.50	0.00
78	0.00	0.00	0.00	1	0.00	12	SMC	18	100.00	99.50	0.00
79	0.00	0.00	0.00	1	0.00	12	SMC	18	100.00	99.50	0.00
80	0.00	0.00	0.00	1	0.00	12	SMC	18	100.00	99.50	0.00
81	0.00	0.00	0.00	1	0.00	12	SMC	18	100.00	99.50	0.00
82	0.00	0.00	0.00	1	0.00	12	SMC	18	100.00	99.50	0.00
83	0.00	0.00	0.00	1	0.00	12	SMC	18	100.00	99.50	0.00
84	0.00	0.00	0.00	1	0.00	12	SMC	18	100.00	99.50	0.00
85	0.00	0.00	0.00	1	0.00	12	SMC	18	100.00	99.50	0.00
86	0.00	0.00	0.00	1	0.00	12	SMC	18	100.00	99.50	0.00
87	0.00	0.00	0.00	1	0.00	12	SMC	18	100.00	99.50	0.00
88	0.00	0.00	0.00	1	0.00	12	SMC	18	100.00	99.50	0.00
89	0.00	0.00	0.00	1	0.00	12	SMC	18	100.00	99.50	0.00
90	0.00	0.00	0.00	1	0.00	12	SMC	18	100.00	99.50	0.00
91	0.00	0.00	0.00	1	0.00	12	SMC	18	100.00	99.50	0.00
92	0.00	0.00	0.00	1	0.00	12	SMC	18	100.00	99.50	0.00
93	0.00	0.00	0.00	1	0.00	12	SMC	18	100.00	99.50	0.00
94	0.00	0.00	0.00	1	0.00	12	SMC	18	100.00	99.50	0.00
95	0.00	0.00	0.00	1	0.00	12	SMC	18	100.00	99.50	0.00
96	0.00	0.00	0.00	1	0.00	12	SMC	18	100.00	99.50	0.00
97	0.00	0.00	0.00	1	0.00	12	SMC	18	100.00	99.50	0.00
98	0.00	0.00	0.00	1	0.00	12	SMC	18	100.00	99.50	0.00
99	0.00	0.00	0.00	1	0.00	12	SMC	18			

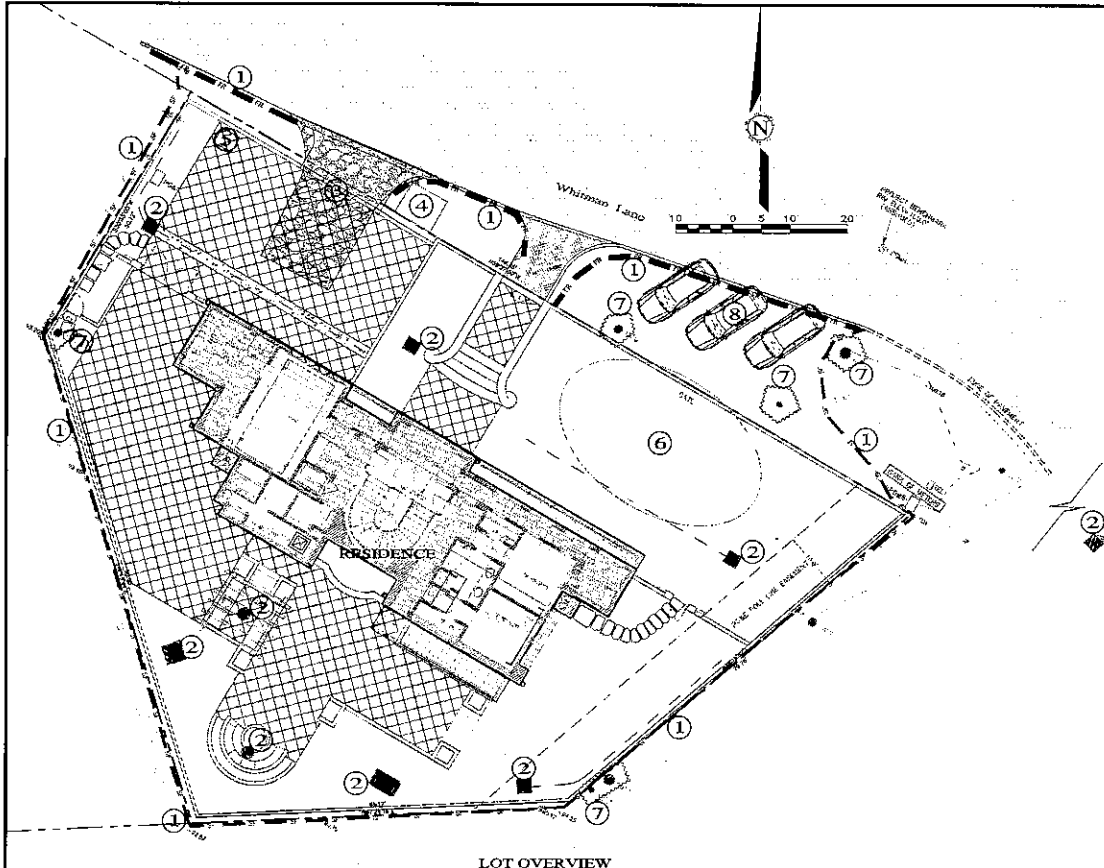

LOT OVERVIEW  
SHEET 1 OF 2

**CONSTRUCTION MANAGEMENT NOTES:**

- PAINTING:**
1. REMOVE USE OF OIL-BASED PAINTS
  2. STORE SOLVENTS AND PAINTS IN ORIGINAL CONTAINERS OR OTHER USE APPROVED CONTAINERS
  3. SPILL SOLVENTS AND PAINTS IMMEDIATELY. THESE SPILLS BELONG TO APPLICANT. CONTAINERS MUST BE KEPT AS NEAR AS POSSIBLE AND USE PAINTS AS MUCH AS POSSIBLE WITHIN 15 MINUTES OF OPENING OF THEM. SPILLS OF OILY SOLVENTS AND UNDESIRABLE PAINTS AS A HAZARDOUS WASTE.
  4. NEVER CLEAN PAINT EQUIPMENT WHERE SOLVENTS, PAINT OR CONTAMINATED RESIDUE WATER CAN ENTER THE CITY SEWER SYSTEM.
  5. CLOSURE AND HANDLING - HAZARDOUS WASTE MANAGEMENT PLAN
- PLASTERING/STUCCO/TILING/SITE-WORKED CONCRETE:**
1. STUCCO, PLASTER AND TILING IS TO BE APPLIED TO ALL EXPOSED AREAS AND KEPT CLEAN THROUGHOUT THE PROJECT.
  2. IF THERE IS LEAK OVER PRODUCE, PLACE THE EXCESS IN AN EXISTING DEPRESSION, LET THE PRODUCT DRY AND REMOVE AS MUCH AS POSSIBLE.
  3. ALL WASTE WATER IS TO BE PLACED IN AN EXISTING DEPRESSION CAPABLE OF HOLDING THE WASTE WATER AS WELL AS ANY NEW WASTE THAT WOULD FALL INTO THE DEPRESSION.
  4. CLOSURE AND HANDLING - HAZARDOUS WASTE MANAGEMENT PLAN
- READY-MIXED CONCRETE:**
1. HAVE AN EXISTING DEPRESSION ONE PRIOR TO THE ARRIVAL OF THE READY-MIX TRUCK.
  2. IF A TRUCK IS UNABLE TO DELIVER THE READY-MIX FROM THE TRUCK AND MUST BE UNLOADED BY THE CONTRACTOR.
  3. PLACE ALL SPILLED CONCRETE AND CURBES WASH WATER IN THE DEPRESSION.
  4. ALL TRUCKS AND PUMP WASTE WATER IS TO BE TAKEN BACK TO THE READY-MIX BATCH PLANT FOR TREATMENT/RECYCLING.
  5. BEFORE CLOSING AN EXPOSED EXISTING FACILITY, CAREFULLY PLAN AND PREPARE TO PREVENT THE SPILLAGE THAT IS CAUSED BY THE TRUCKS AND THE READY-MIX BATCH PLANT AND OTHERS.
  6. CLOSURE AND HANDLING - HAZARDOUS WASTE MANAGEMENT PLAN
- EARTH MOVING/LOADING:**
1. REMOVE COVERED VEGETATION ONLY WHEN NECESSARY.
  2. PLANT TEMPORARY VEGETATION WHEN SOILS HAVE BEEN RESTORED BUT CONSTRUCTION IS STILL ONGOING TO PROTECT EXISTING PLANT.
  3. PROTECT DOWN SLOPE DRAINAGE CORRESSES BY RECONSTRUCTED METHODS SUCH AS THOSE IN THE CASES AND OTHERS.
  4. THE TRUCKS MUST BE SUBJECT TO CLEAN WATER WASHING OPERATIONS.
  5. CONTAINERS OF EXHAUSTION GAS MUST BE KEPT.
  6. SCHEDULED WASHING ACTIVITIES SHOULD BE KEPT.
  7. CLOSURE AND HANDLING - EROSION CONTROL.
- PORTABLE SANITATION FACILITIES:**
1. LOCATE ALL FROM DRINKING FACILITIES, WATERWORKS, AND FROM TRAFFIC CIRCULATION.
  2. LOCATE ALL FROM DRINKING FACILITIES, WATERWORKS, AND FROM TRAFFIC CIRCULATION.
  3. WASTEWATER SHOULD NOT BE DISCHARGED OR RAINED WITHIN THE PROJECT SITE.
  4. CONTAINERS OF EXHAUSTION GAS MUST BE KEPT.
  5. CONTAINERS OF EXHAUSTION GAS MUST BE KEPT.
  6. WASTEWATER SHOULD NOT BE DISCHARGED OR RAINED WITHIN THE PROJECT SITE.
  7. CLOSURE AND HANDLING - HAZARDOUS WASTE MANAGEMENT PLAN

**LEGEND:** (SEE B.A.P. DETAILS PER C.O.S. STD. PLANS 30A & 30B)

1. TIREN ROLL AND/OR SILEY FENCE, INSTALL TIREN ROLL AT BACK OF AD DRIVE ALONG PROPERTY FRONTAGE.
2. SHEET PROTECTIVE USE GRAVEL/SAND BASE.
3. STABILIZED CONSTRUCTION ENTRANCE.
4. CONCRETE WASHOUT FACILITY.
5. PORTABLE SANITATION FACILITY.
6. TEMPORARY STOCKPILE AREA.
7. TREE PROTECTION.
8. EMPLOYEE PARKING AREA.

**NOTES**

1. PRIOR TO COMMENCEMENT OF ANY LAND DISTURBANCE, THE OWNER/APPLICANT SHALL SUBMIT AN INSPECTION WITH ERM, ENVIRONMENTAL SERVICES TO OBTAIN ALL NECESSARY EROSION CONTROL AND ERM PLAN AND THE PROJECT IS COMPLIANT WITH MONTEREY COUNTY GRADING AND EROSION CONTROL REGULATIONS.
2. IN OBTAINING CONSTRUCTION THE OWNER/APPLICANT SHALL SUBMIT AN INSPECTION WITH ERM, ENVIRONMENTAL SERVICES TO OBTAIN CONSTRUCTION TEST RECORDS, INSPECTOR SIGNATURE DEVICE INSTALLATION, REVIEW THE MAINTENANCE AND EFFECTIVENESS OF BMP'S INSTALLED, AS WELL AS TO VERIFY THAT PRELIMINARY ERM PLAN IS NOT REQUIRED FROM THE SITE.
3. PRIOR TO FINAL INSPECTION, THE OWNER/APPLICANT SHALL SUBMIT AN INSPECTION WITH ERM, ENVIRONMENTAL SERVICES TO VERIFY THAT ALL GRADING OPERATIONS, EXCEPT FINAL GRADING OPERATIONS, THAT ALL EXISTING AREAS HAVE BEEN PROTECTED AND THAT ALL TEMPORARY EROSION AND SEDIMENT CONTROL MEASURES THAT ARE IN PLACE WITHIN 15 MINUTES BEFORE THE START OF EACH PROJECT CONSTRUCTION. THE OWNER OR CONTRACTOR MAY BE REQUIRED TO KEEP ADEQUATE EQUIPMENT ON THE GRADING SITE TO PREVENT TYPICAL FAILURE.
4. IT SHALL BE THE RESPONSIBILITY OF THE OWNER AND THE PERMITS TO ENSURE THAT EROSION DOES NOT OCCUR FROM AN ACTIVITY DURING THE COURSE OF THE PROJECT CONSTRUCTION. ADDITIONAL MEASURES, BEYOND THOSE SPECIFIED, MAY BE REQUIRED AS DEMAND NECESSARY TO CONTROL ALLEGED EROSION.
5. TEMPORARY EROSION CONTROL TO BE INSTALLED BETWEEN OCTOBER 1 AND APRIL 30.
6. THE EROSION CONTROL SHALL BE INSTALLED TO PREVENT ALL EXISTING VEGETATION, TREES, AND OTHER VALUABLE MATERIALS, AND SCOURING THE GROUND TO PROVIDE A BOND WITH THE FILL MATERIAL.

TABLE THREE REQUIRED INSPECTIONS AND INTERESTED PARTIES

Inspection/Activity	Frequency	Interested Party
Pre-construction Inspection	Once	ERM, ERM Services
Construction Inspection	As Needed	ERM, ERM Services
Final Inspection	Once	ERM, ERM Services
Post-construction Inspection	As Needed	ERM, ERM Services
Other		

**Material Delivery and Storage WM-1**

**Description and Purpose:** Provide a designated area for the storage of materials and equipment. The area shall be located in a well-ventilated area and shall be protected from weather conditions. The area shall be maintained in a clean and organized manner.

**Typical Construction:**

- 1. Concrete
- 2. Steel
- 3. Wood
- 4. Other

**Permitted Alterations:** None

**Solid Waste Management WM-5**

**Description and Purpose:** Provide a designated area for the collection and storage of solid waste. The area shall be located in a well-ventilated area and shall be protected from weather conditions. The area shall be maintained in a clean and organized manner.

**Typical Construction:**

- 1. Concrete
- 2. Steel
- 3. Wood
- 4. Other

**Permitted Alterations:** None

**Hazardous Waste Management WM-6**

**Description and Purpose:** Provide a designated area for the collection and storage of hazardous waste. The area shall be located in a well-ventilated area and shall be protected from weather conditions. The area shall be maintained in a clean and organized manner.

**Typical Construction:**

- 1. Concrete
- 2. Steel
- 3. Wood
- 4. Other

**Permitted Alterations:** None

**Solid Waste Management WM-5**

**Description and Purpose:** Provide a designated area for the collection and storage of solid waste. The area shall be located in a well-ventilated area and shall be protected from weather conditions. The area shall be maintained in a clean and organized manner.

**Typical Construction:**

- 1. Concrete
- 2. Steel
- 3. Wood
- 4. Other

**Permitted Alterations:** None

DATE	BY	REVISION
02/19/18	AMS	ARCHI'S SITE PLAN REVIEW
07/14/18	AMS	ARCHI'S SITE PLAN REVIEW
12/14/18	AMS	ARCHI'S SITE PLAN REVIEW
07/10/18	AMS	PROJECT IMPACT ASSESSMENT
08/25/18	AMS	IMP/IA/C
12/14/18	AMS	ARCHI'S NEW SITE PLAN
02/30/18	AMS	ARCHI'S NEW SITE PLAN
03/23/18	AMS	INTEGRATE TO CLIENT
03/10/18	AMS	CONCEPTUAL ERM & B.A.P. PLAN



APPROVED BY:  
PHILLIP B. BEACH  
CITY OF MONTEREY



**"EROSION & SEDIMENT CONTROL PLAN"**  
**GRADING, DRAINAGE, EROSION CONTROL**  
**& STORM WATER CONTROL PLANS**  
 RAVEN RESIDENCE  
 A.P.N.: 008-401-010  
 PHILLIP B. BEACH, MONTEREY COUNTY, CALIFORNIA  
 MR. & MRS. SCOTT AND CHARLISSE RAVEN

SCALE: AS SHOWN  
DATE: APRIL 2016  
JOB NO. 1220-01  
SHEET C7-EC  
OF 8 SHEETS



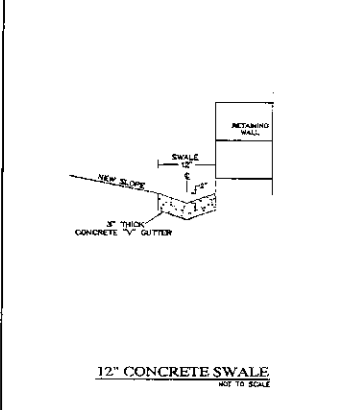
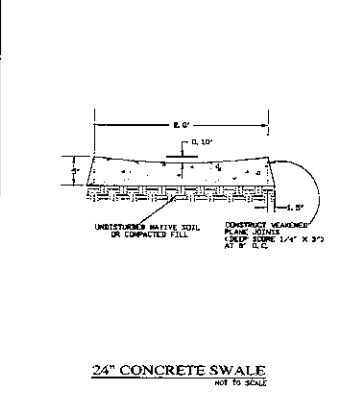
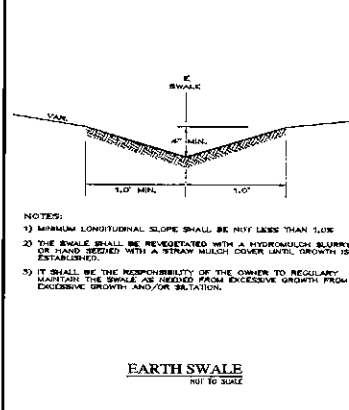
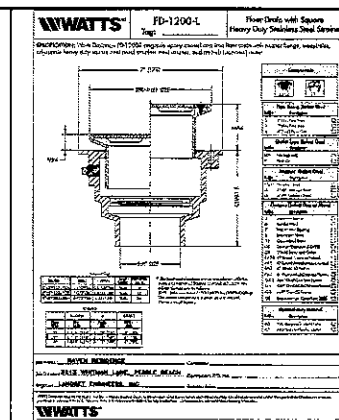
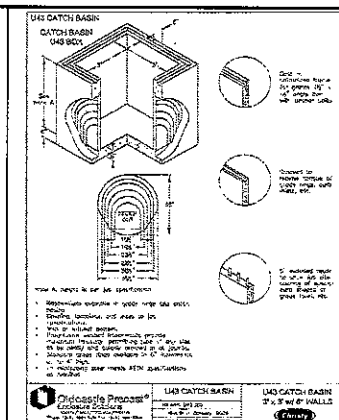
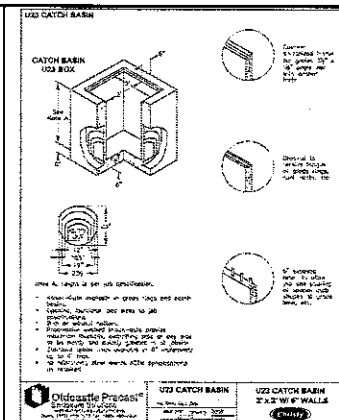
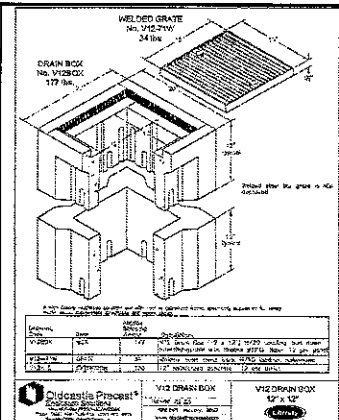
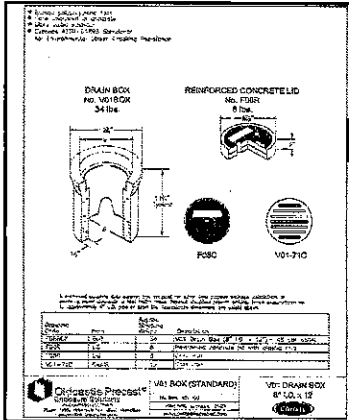

BLANK

BLANK

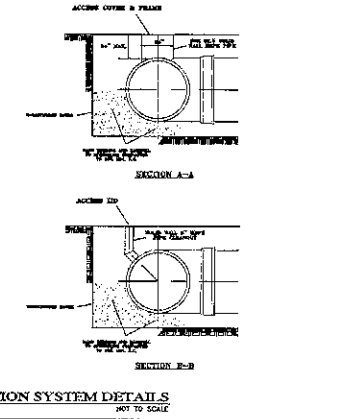
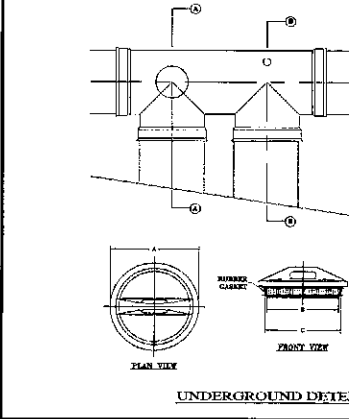

BLANK

BLANK

" STANDARD PLANS & CONSTRUCTION DETAILS "

**GRADING, DRAINAGE, EROSION CONTROL & STORM WATER CONTROL PLANS**

RAVEN RESIDENCES  
A.P.N.: 005-40-010  
PERLU BEACH, MONTEREY COUNTY, CALIFORNIA  
MR. & MRS. SCOTT AND CHARMYLS RAVEN

APPROVED BY:  
JUDY P. GRABHO

**LANDSET**  
ENGINEERS, INC.  
5000 CALIFORNIA AVENUE, SUITE 200  
CARMEL, CALIFORNIA 95008  
(408) 925-1000

NO.	DATE	BY	REVISION
02/19/18	AMS	ARCH'S SITE PLAN REVIEW	
01/14/18	AMS	ARCH'S SITE PLAN REVIEW	
02/16/18	AMS	ARCH'S SITE PLAN REVIEW	
02/09/18	AMS	PROJECT MEETING ASSEMBLY	
08/27/17	AMS	DESIGNED	
04/20/17	AMS	ARCH'S NEW SITE PLAN	
06/20/16	AMS	ARCH'S NEW SITE PLAN	
05/20/16	AMS	REVISION TO CONCEPT	
05/12/16	AMS	CONCEPTUAL D.R. & ENCL. PLAN	

SCALE: AS SHOWN  
DATE: APRIL 2018  
SHEET NO. 1520-01  
SHEET **08**  
OF 8 SHEETS