

Attachment J

This page intentionally left blank.

SOIL

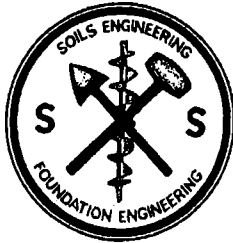

SURVEYS GROUP INC.

103 CHURCH ST • SALINAS, CALIFORNIA 93901 • TELEPHONE (831) 757-2172

February 23, 2018
Job #7044

McIntosh Enterprises
c/o Wald Ruhnke & Dost Architects
Attn: Mr. Armando Guido-Lopez
2340 Garden Road, Suite 100
Monterey, CA 93940

Dear Mr. Guido-Lopez:

Submitted herewith is the report of our Geotechnical Investigation for the proposed new apartment complex to be located at 24491 Citation Court, APN 173-121-005, in Monterey, California. Four borings were drilled on January 23, 2017 for geotechnical investigation purposes. Laboratory tests were subsequently made on driven soil core samples taken from the test borings to determine the near surface and subsurface soil conditions and suitability for the proposed new apartment complex. We find that the project site is suitable for the proposed use with the recommendations made herein.

It is a pleasure working with you on this project. If you have any questions regarding our geotechnical investigation or this report, please contact us.

Very truly yours,

SOIL SURVEYS GROUP, INC.

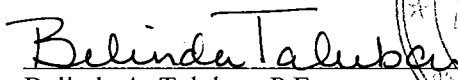
Belinda A. Taluban, P.E.
R.C.E. 44217

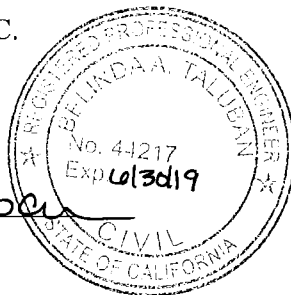

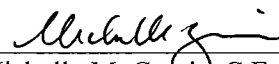
Michelle M. Garcia, C.E.G.
Engineering Geologist 2668

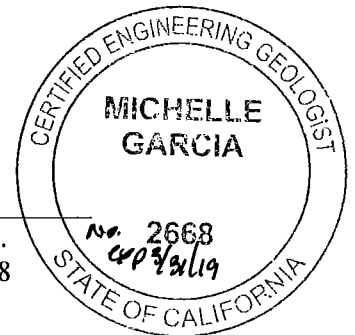

BAT/MMG/ke

cc. Monterey County Resource Management Agency Divisions of Planning and Building Inspection

TABLE OF CONTENTS

<u>SECTION</u>	<u>PAGE</u>
I. Introduction	1
II. Laboratory Test Data	2
III. Suitability of Site for Proposed Use	5
IV. Recommended Foundation Design Criteria	5
A. Concrete Sidewalks and Outside Flatwork	6
V. Loose and Expansive Soil Mitigation	6
VI. Surface and Subsurface Drainage and Erosion Considerations	7
VII. Retaining Wall Design Criteria	7
VIII. Recommended Specifications	8
A. Grading	8
B. Compaction	9
C. Concrete Floor Slabs-on-Grade	9
D. Utility Trench Backfill	10
E. Pavement Design Criteria	10
IX. Geologic and Seismic Considerations	11
X. Unforeseen or Unusual Conditions	12
XI. Conclusions and Recommendations	12
XII. Limitations	13
Figure I - Site Location Map	
Figure II - Boring Locations (approx.)	
Appendix A - Boring Logs	
Appendix B - Direct Shear Test	
Appendix C - R-Value Test	

SOIL



**SURVEYS
GROUP INC.**

103 CHURCH ST • SALINAS, CALIFORNIA 93901 • TELEPHONE (831) 757-2172

GEOTECHNICAL AND INFILTRATION INVESTIGATION

FOR THE PROPOSED NEW APARTMENT COMPLEX

AT 24491 CITATION COURT, APN 173-121-005

MONTEREY, CALIFORNIA

FOR MCINTOSH ENTERPRISES

FEBRUARY 23, 2018; JOB #7044

I. INTRODUCTION:

This Geotechnical Investigation was made to determine the suitability of the soils at the project site for the proposed new apartment complex to be located at 24491 Citation Court, APN 173-121-005, in Monterey, California. Four borings were drilled on January 23, 2018 for geotechnical investigative purposes. Core samples were taken from the borings for laboratory testing. The boring logs, our field observations, and field and laboratory test data were analyzed to determine the following:

1. **Suitability of the soils at the project site for the proposed new apartment complex.**
2. **Expansive, unsuitable or unstable soil conditions, if any.**
3. **Foundation and retaining wall design criteria for the proposed new buildings.**
4. **Subsurface groundwater and soil moisture considerations.**
5. **Surface drainage considerations and storm water infiltration criteria.**
6. **Pavement design criteria for circulation and parking areas.**
7. **Analysis of seismic hazards and seismic design factors per the 2016 California Building Code.**

Site Setting: The project consists of a multi-building apartment complex. The project is located within a 2.87 acre vacant parcel, on the east side of Citation Court. The general topography of the parcel slopes from north to south with an approximate gradient of 20 percent from the northern extent of the parcel to the approximate location of the building envelope and then lessens to an approximate gradient of 15 percent to the existing paved roadway at the southern extent of the parcel. The site is well vegetated with a mixture of Coast Live Oak (*Quercus agrifolia*), native shrubs, Hottentot fig (*Carpobrotus edulis*), and grasses. There is evidence of minor rodent activity. There is an erosional depression located near the westernmost extent of the paved roadway at the southern end of the parcel. Other than the aforementioned rodent activity and erosional feature within the southwesterly corner of the parcel, there are no signs of significant erosion, mass movement, or sliding at the subject property.

II. LABORATORY TEST DATA¹:

Twenty-seven moisture density tests were made from the driven core samples. Standard Penetration Tests (SPT) were performed with a Terzaghi Split Spoon sampler. Core samples were also taken with a 2½-inch interior diameter (i.d.) Modified California Sampler. All samplers were driven into the soil by a 140 lb. hammer dropped a vertical distance of 30 inches at each of the sample locations. Results of these tests are shown as follows:

MOISTURE DENSITY TESTS					
Boring No.	Depth/ Ft.	Water Content %	Dry Density p.c.f.	Standard penetration Tests, Blows /foot	Pocket Penetrometer Tons S.F.
B-1	2-2.5	16.6	51.0	3	---
B-1	5.5-6	12.9	116.5	38	0.5
B-1	6.5-7	14.6	112.1	30(18)*	>4.5
B-1	7-7.5	23.7 +	100.5 +	48(29)*	>4.5
B-1	9.5-10	13.6	104.7	36	1.75
B-1	14.5-15	13.4	104.9	37	3.75
B-1	19.5-20	11.7	93.2	40	---
B-1	24.5-25	8.9	100.1	51	---
B-2	2-2.5	4.7	76.3	5	---
B-2	3.5-4	4.1	103.7	12(7)*	1.0
B-2	4-4.5	2.6	99.8	18(11)*	1.0
B-2	5.5-6	3.1	101.4	14	---
B-2	9.5-10	9.9	100.7	65	---
B-2	14.5-15	10.5	107.0	90	---
B-2	19.5-20	14.2	114.5	95	---
B-3	2-2.5	8.1	92.7	36	>4.5
B-3	4-4.5	9.6	99.6	64	>4.5
B-3	6-6.5	16.3	92.7	28	>4.5

¹Boring Logs are located in Appendix A

McIntosh Enterprises
 February 23, 2018
 Job #7044

Boring No.	Depth/ Ft.	Water Content %	Dry Density p.c.f.	Standard penetration Tests, Blows /foot	Pocket Penetrometer Tons S.F.
B-3	9.5-10	12.7	105.1	45	>4.5
B-3	14.5-15	12.4	88.1	25	2.0
B-3	19.5-20	6.6	101.5	40	---
B-4	2-2.5	7.6	84.4	14	1.0
B-4	4-4.5	4.4	104.8	27	---
B-4	6-6.5	10.6	101.5	41	1.0
B-4	9.5-10	7.3	105.3	80	0.5
B-4	14.5-15	5.3	105.2	44	0.25
B-4	19.5-20	5.8	101.1	53	1.0

* = 2.5 -inch mod. Cal, not SPT () = Blow counts adjusted to approximate SPT values
 + = Direct Shear Test - Average values shown

Six Sieve Analysis tests were made from the driven core samples. Results of these tests are shown as follows:

<i>A.S.T.M. D 422 SIEVE ANALYSIS TEST-Percent Passing</i>								
Boring No.	Depth/ Ft.	Sieve No. 4	Sieve No. 10	Sieve No. 20	Sieve No. 30	Sieve No. 40	Sieve No. 100	Sieve No. 200
B-1	2-2.5	96	94	90	88	85	51	35
B-1	6.5-7	99	97	94	92	90	60	52
B-2	2-2.5	99	98	96	95	91	35	18
B-3	4-4.5	100	99	95	93	90	63	50
B-4	2-2.5	100	99	96	94	91	52	37
B-4	4-4.5	99	98	95	93	90	41	27

Six plasticity index tests were performed on driven core samples. Results of these tests are as follows:

PLASTICITY INDEX TEST						
Test Hole No.	Depth/ Feet	% Passing Sieve No. 40	% Passing Sieve No. 200	Liquid Limit	Plastic Limit	Plasticity Index
B-1	2-2.5	85	35	19	15	4
B-1	6.5-7	90	52	33	13	20
B-2	2-2.5	91	18	n/p	non plastic	n/p
B-3	4-4.5	90	50	32	13	19
B-4	2-2.5	91	37	n/p	non plastic	n/p
B-4	4-4.5	90	27	n/p	non plastic	n/p

The test results for the samples taken from the borings indicate that the fine fraction of the near surface silty, slightly clayey, fine to medium grained sandy soils in Boring 1 at 2.0 to 2.5 feet are slightly expansive and slightly plastic and Boring 2 at 2.0 to 2.5 and Boring 4 at 2.0 to 2.5 and 4.0 to 4.5 feet are non-expansive and non-plastic. The fine fraction of the subsurface silty, clayey, fine to medium grained sandy soils in Boring 1 at 6.5 to 7.0 feet and Boring 3 at 4.0 to 4.5 feet are slightly to moderately expansive and slightly to moderately plastic.

One Direct Shear test was made from driven core samples taken from the borings. Results of this test are summarized as follows (see Appendix B for full report sheet):

Boring No.	Depth/ Ft.	Internal Frict. Angle, ϕ°	Cohesion, C p.s.f.	Soil Weight p.c.f.	Description of soil
B-1	7-7.5	28.2	650	124.3	Dark grey sandy CLAY with pockets of clayey sand

Boring 1 was located within the northeastern corner of proposed building, as shown on Figure II. The near surface soil consists of very loose, slightly clayey, silty, fine to medium grained sand with organics to a depth of three feet overlying medium dense, silty, clayey, fine to coarse grained sand with scattered fractured gravels to a depth of 13.0 feet in depth. Below this depth, the soil consists of dense to very dense, silty, slightly clayey, fine to coarse grained sand with fractured shale gravels to the bottom of the boring at 25.0 feet.

Boring 2 was located within the southeastern corner of proposed building, as shown on Figure II. The near surface soil consists of loose, silty, fine to medium grained micaceous sand to a depth of four feet overlying medium dense, silty, fine to medium grained sand to a depth of 8.5 feet. Below this depth, the soil consists of very dense, slightly silty, fine to medium grained sand to the bottom of the boring at 20.0 feet.

Boring 3 was located within the northwestern corner of the proposed parking area, as shown on Figure II. The near surface soil consists of dense to very dense, clayey, silty, fine to coarse grained cemented sand with scattered gravels to a depth of five feet underlain by medium dense to dense, silty, clayey, fine to coarse grained weakly cemented sand clay to a depth of 13.5 feet. Below 13.5 feet in depth, the soil consists of medium dense to dense, silty, clayey, fine to coarse grained cemented sand to the bottom of the boring at 20.0 feet.

Boring 4 was located within the southwestern corner of the proposed building, as shown on Figure II. The near surface soil consists of loose, silty, fine to medium grained cemented sand to a depth of two feet underlain by medium dense to dense, silty, fine to medium grained cemented sand to a depth of 8.5 feet. Below this depth, the soil consists of dense to very dense, fine to medium grained sand to the bottom of the boring at 20.0 feet.

No groundwater was observed in any of the borings to a maximum explored depth of 25.0 feet, prior to backfilling the holes with soil cuttings on the date of drilling. The actual depth to groundwater during rainy months is unknown, but it should be noted that groundwater fluctuations can occur due to variations in rainfall, temperature and other factors not evident during the time of our investigation.

III. SUITABILITY OF SITE FOR PROPOSED USE:

No unsuitable or unstable soil conditions were found at the proposed new apartment complex location except for very loose to loose near surface soils to a depth of three feet and of slightly to moderately expansive soils at footing depths. In our opinion, the site is suitable for the proposed apartment buildings with the recommendations made herein, specifically the recommendations for recompaction of loose soil and mitigation for expansive soil.

IV. RECOMMENDED FOUNDATION DESIGN CRITERIA:

Spread footings may be used for the building foundations after the site is cleared, grubbed and the proposed building pads are graded, compacted and properly prepared. Spread footings shall be installed to a minimum depth of 18 inches below lowest adjacent grade for one and two story portions of the buildings. The minimum depths shall be measured from the **inside building pad soil subgrade**. Mitigation for recompaction of loose soil conditions must be followed.

Allowable foundation pressures after proper compaction of the building pad areas are:

Continuous footings	= 1700 p.s.f.
Isolated rectangular footings	= 2000 p.s.f.

We recommend that continuous footings shall be reinforced with three #4 steel reinforcement bars, two placed near the bottom of footing and one placed near the top of the footing. Spread footings shall also meet the minimum requirements of the 2016 California Building Code for width, thickness, embedment and reinforcement steel. The new apartment complex buildings and any future additions shall be designed in strict accordance with the requirements specified in the 2016 California Building Code, or latest approved edition, to resist seismic forces.

All concrete floor slabs-on-grade shall be a minimum of five inches thick and shall be reinforced with a minimum of #3 steel reinforcement bars at 16 inches on center or #4 steel reinforcement bars placed 30 inches on center, each way and shall be extend into perimeter foundation. *The reinforcement steel must be firmly held in the vertical center of the slabs during placement and finishing of concrete with pre-cast concrete dobies.* All new concrete floor slabs-on-grade shall be underlain by an approved 15 mil. vapor barrier installed over a minimum four inch thick open graded gravel capillary break with two inches of clean sand placed over the vapor barrier as recommended in Section VIII herein. ***Concrete slabs shall have weakened plane joints a maximum of fifteen feet on center, each way. All concrete shall be properly cured with an approved curing compound or wetted burlap for a minimum of 14 days.***

Soil Surveys Group, Inc. shall inspect and approve the foundation footing excavations and the subgrade beneath concrete floor slabs for suitable soil bearing and proper penetration into competent soil. We also recommend that Soil Surveys Group, Inc. review and approve the grading, drainage and foundation plans prior to building construction.

A. Concrete Sidewalks and Outside Flatwork:

We recommend that any new on-site concrete sidewalks and outside flatwork be at least five inches thick and be placed over a compacted subgrade. All concrete flatwork should be divided into as nearly square panels as possible. Frequent joints should be installed to provide articulation to the concrete panels. Landscaping and planters adjacent to concrete flatwork should be designed in such a manner that positive drainage away from the new project buildings is achieved. It is assumed that the outside concrete flatwork will be subjected only to pedestrian traffic.

V. LOOSE AND EXPANSIVE SOIL MITIGATIONS:

To mitigate the effects of the loose and expansive near surface soil conditions, the following measures are recommended:

1. All existing loose soil within the proposed building envelopes and extending a minimum of five feet in all directions outside of the proposed building foundations shall be recompacted **as necessary** to 90 percent relative compaction at the direction of Soil Surveys Group, Inc. prior to placing any additional building pad fill or finishing the building pad subgrade. Soil Surveys Group, Inc. shall determine the depth of recompaction, one to three feet is anticipated, within the building perimeter after the building sites are cleared and grubbed.
2. If the new buildings will bear on both cut and fill, the cut portion of the building pads shall be subexcavated and recompacted a minimum of two feet deep for a distance of five feet outside the building, so that the entire building overlies engineered fill, prior to excavating for the foundation footings.
3. Spread footings shall be constructed a minimum of 18 inches below grade for the proposed apartment buildings as measured from the lowest adjacent grade and continuous non-retaining footings shall be reinforced with four steel reinforcement bars, two placed near the bottom of the footing and two placed near the top of the footing.
4. All concrete floor slabs-on-grade shall be a minimum of five inches thick and shall be reinforced with a minimum of #3 steel reinforcement bars at 16 inches on center or #4 steel reinforcement bars at 30 inches on center, each way.

5. Roof and site rain water should be directed away from the proposed building foundations. Rainfall runoff must not be allowed to collect or flow in a downslope direction against any new or existing building foundations.
6. Soil Surveys Group, Inc. shall be retained to inspect and test the recompaction of all loose soil and engineered fill within the building pad perimeters and shall inspect and approve foundation and any retaining wall footing excavations for soil bearing conditions. Soil Surveys Group, Inc. shall also inspect and approve the subgrade below concrete floor and garage slabs-on-grade prior to placement of reinforcing steel and shall inspect and approve the installation of all roof and site drainage facilities.

VI. SURFACE AND SUBSURFACE DRAINAGE AND EROSION CONSIDERATIONS:

The near surface soil at the project site has the potential to erode, especially if protective vegetation is removed. Therefore all new cut and fill slopes, as well as disturbed soil areas, must be seeded with grass or landscape plants for erosion control and to prevent sloughing soil from blocking drainage patterns at the project site. Such erosion control measures shall be taken during and at completion of grading and during building construction operations.

Concentrated storm water runoff from the project site should not be allowed to discharge uncontrolled onto sloping ground. Suitable energy dissipation systems shall be designed where rainfall runoff is concentrated, or the drainage water should be collected and piped to flat ground or discharged onto a rock energy dissipater down slope of the building foundations. Rock energy dissipaters consisting of four inch to six inch diameter rock or rubble rip rap should be installed at collection pipe discharge points to reduce soil erosion. Rain gutter downspouts shall discharge onto concrete splash blocks, or shall discharge into collector pipes. The building sites, any new paved areas and ground adjacent to the buildings shall be graded so that rainfall runoff does not become trapped or flow against any building foundations.

The boring logs do not indicate the need for a subsurface drain system at this time, however the Geotechnical engineer may recommend a system of subsurface drains should wet subsurface soil conditions be encountered during site preparation or excavations for any new building foundations.

VII. RETAINING WALL DESIGN CRITERIA:

The following design criteria are recommended for the project retaining walls:

<i>Friction Angle</i>	ϕ	= 28.2 °
<i>Cohesion</i>	c	= 650 p.s.f.
<i>Soil Weight,</i>	w	= 124.3 p.c.f.
<i>Equivalent fluid pressure, active</i>		= 45 pounds per square foot per foot of depth for Level Grade
<i>Equivalent fluid pressure, active</i>		= 64 p.c.f. with 2:1 slope behind wall
<i>Equivalent fluid pressure, at rest,</i>		= 66 p.c.f., <i>restrained condition</i>
<i>Equivalent fluid pressure, passive</i>		= 347 p.c.f.
<i>Sliding friction</i>	f	= 0.35
<i>Allowable Footing Toe Pressure</i>		= 2500 p.s.f. plus $\frac{1}{3}$ additional for seismic force (if added)

Retaining walls that are part of or within ten feet of a building should include the seismic force of the soil against the wall. The estimated seismically generated ground accelerations to be used for this area are:

$$\text{PAGA} = 0.361g$$

$$\text{RHGA} = 0.24g = k_h$$

$$w = 124.3 \text{ p.c.f.}$$

The resultant seismic force is calculated by the formula: $3/8 w H^2 k_h$ per linear foot of retaining wall, or for this case $11.1 H^2$, where H is the height of the retaining wall. *These forces, where needed, should be applied at a height of $0.6H$ above the base of the retaining wall and must be combined with the force produced by active soil pressure.*

These retaining wall design criteria are based on a fully drained condition. Therefore, we recommend that a four-inch diameter perforated NDS or PVC pipe be installed behind or along the top of the footing, holes placed down, behind all walls that retain earth. The pipe shall be covered with a 12-inch wide envelope of 3/4-inch drain rock or Class 2 Permeable Material (per Caltrans Standard Specifications Section 68-1.025) which shall extend to within one foot of the level of retained soil. Filter fabric shall be installed over the top of the drain rock. No gravel shall be placed below the pipe. The remainder of the trench can be backfilled with clean native sand. As an alternative to installing drain rock or permeable material, a composite filter material, eg, Miradrain, can be installed with a perforated pipe at the bottom of the material. Clean-out risers must be installed on the perforated pipe at the up-stream ends, every 100-feet, and at 90° angle points. The capped end of the cleanout riser shall be located at the ground surface outside of or behind the retaining walls.

VIII. RECOMMENDED SPECIFICATIONS:

A. GRADING:

The building pads, extending a minimum of five feet in each direction past new foundation footings shall be cleared and grubbed of all surface vegetation, demolition debris, and organic topsoil before recompacting the original ground, placing engineered fill or finishing the subgrade for the new apartment buildings. On site surface or subsurface grass, roots, deleterious material, or brush (if any) within any new building pad areas shall be removed. Soil Surveys Group, Inc. should determine if any subexcavation is necessary after clearing and grubbing are completed, one to three feet from existing ground is anticipated. All subexcavated soil shall then be backfilled in eight inch loose lifts and recompacted to 90 percent relative compaction, prior to placing engineered fill or finishing subgrade of the new building pads.

Any new cut and fill slopes shall be 2:1 or flatter unless retained. The native soil is suitable to be used as engineered fill provided any organics or debris are first removed from the soil to be used as fill. Any native soil used for fill, or any imported fill soil for the new building pads shall be compacted to at least 90 percent relative compaction, and any cut portions of a new building pads, if located within both cut and fill, shall be subexcavated a *minimum* of two feet, backfilled in eight inch loose lifts and recompacted to a minimum of 90 percent relative compaction. All fills placed on slope grades of 5:1 or greater shall be provided with a keyway excavated a minimum of two feet below grade, a minimum of 10 feet wide and at a 2% slope into the slope. The bottom of the keyway should be moisture conditioned, compacted (if necessary) and approved by Soil Surveys Group, Inc. prior to backfilling in eight inch loose lifts and compacting the backfill to 90 percent relative compaction. *Grading, filling, compaction operations and foundation excavations shall be inspected and tested by Soil Surveys Group, Inc.*

B. COMPACTION:

Laboratory soils compaction test method shall be *A.S.T.M. D 1557-09*. Subgrade in existing soil beneath the new building pads shall be compacted to 90 percent relative compaction unless waived by the Geotechnical engineer. The upper 12" of subgrade soil below any new pavement shall be compacted to 95 percent relative compaction, and aggregate base beneath new pavement shall be compacted to 95 percent relative compaction. Any imported sandy soil fill placed for the new building pads shall be compacted to a minimum of 95 percent relative compaction.

C. CONCRETE FLOOR SLABS-ON-GRADE:

Subgrade in recompacted soil under any new concrete floor slabs-on-grade shall be brought to at least 2% over optimum moisture prior to placing native or imported sandy soil fill, prior to placing the capillary break rock and moisture proof barrier or prior to pouring concrete. We recommend that a capillary break consisting of:

- a mat of clean, open graded rock, four inches thick, shall be placed over the finished soil subgrade
- a minimum 15 mil. water-proof membrane (such as Stego, Moistop or equal) shall be placed over the open graded rock
- two inches of clean, moistened sand shall be placed between the water-proof membrane and the bottom of the concrete floor slab. The moistened sand will help protect the membrane and will assist in equalizing the concrete curing rate to minimize shrinkage cracking.

Class 2 Aggregate Base or sand should not be used as the capillary break material. Capillary break material shall comply with and be installed according to the following:

1. MATERIAL:

The mineral aggregate for use under the floor slabs shall consist of broken stone, crushed or uncrushed gravel, quarry waste, or a combination of the above. The aggregate shall be free of adobe, vegetable matter, loam, volcanic tuff and other deleterious materials. It shall be of such quality that the absorption of water in a saturated, surface dry condition does not exceed 3% of the oven dry weight of the sample.

2. GRADING:

The mineral aggregate shall be of such size that the percentage composition by dry weight as determined by laboratory sieves (U.S. Sieves) will conform to the following grading:

Sieve Size	Percentage Passing Sieve
3/8" to 1/2"	100
No. 4	0-10
No. 200	0-2

3. PLACING:

Subgrade, upon which aggregate base, gravel or crushed rock is to be placed, shall be prepared by removing grass and roots. Where loose topsoil is present, it shall be removed and cleaned of debris and recompacted to 90 percent of maximum density.

4. THICKNESS AND STRENGTH:

Concrete slabs should be at least five inches thick. Concrete shall be five sack minimum (5.5 sack if pumped) and shall achieve a 28 day compressive strength of at least 2500 p.s.i., or as specified by the project engineer.

5. REINFORCEMENT:

Concrete slabs-on-grade shall be reinforced with a minimum of #3 steel reinforcement bars placed 16 inches on center, each way, or #4 steel reinforcement bars placed 30 inches on center, each way, and shall be bent to extend a minimum of eight inches into the perimeter footings.

D. UTILITY TRENCH BACKFILL:

All new on-site utility trenches shall be backfilled with a clean sand having a sand equivalent of 30 or higher. A two feet thick plug of compacted, **clayey soil backfill** or lean concrete shall be required around the pipe or conduit at places where utility trenches intersect the building perimeters. All trench backfill of imported clean sand shall be compacted to 95 percent relative compaction at all locations. Clean native sand shall be approved by Soil Surveys Group, Inc. prior to using for trench backfill.

E. PAVEMENT DESIGN CRITERIA:

A representative composite sample of the native subgrade and an R-value test was run. The R-Value was 62, which indicates that the soil is moderately strong for pavement support purposes. Based on the Traffic Indices given in the table below, asphalt pavement should consist of the relevant thickness of Hot Mix Asphalt (HMA) over the relevant thickness of Class 2 Aggregate Base (AB), compacted to 95 percent relative compaction. The underlying soil subgrade shall be proof rolled and recompacted (if necessary) to 95 percent relative compaction. Soil Surveys Group, Inc. shall test and approve the finished soil subgrade and finished subgrade of Class 2 Aggregate Base.

Traffic Index(T.I.)	Thickness of H.M.A.	Thickness of A.B.
4	2" (0.15 ft)	4" (0.33 feet)
5	2.5" (0.20 feet)	5" (0.40 feet)
6	3" (0.25 feet)	6" (0.50 feet)

As an alternative to new asphalt pavement in vehicular traffic areas, concrete pavement can be installed. If concrete pavement is selected for the vehicular traffic areas, we recommend that the concrete paving be a minimum of six inches thick over a soil subgrade compacted as necessary to a minimum of 90 percent relative compaction. Concrete shall be reinforced with a minimum of #4 steel bars placed no more than 30 inches on center, each way.

IX. GEOLOGIC AND SEISMIC CONSIDERATIONS:

Monterey County is in a seismically active area of the state of California. The following table provides a list of faults that could produce an earthquake that could impact the project site:

Fault Name	Approximate Distance to Site	Orientation from Site	Data Source
Seaside (Concealed)	0.56 km	West	Clark and others, 1997
Chupines (Certain)	1.13 km	Southwest	Clark and others, 1997
Ord Terrace (Concealed)	1.51 km	Northeast	Clark and others, 1997
Monterey Bay-Tularcitos	4.0 km	West	Uniform Building Code, 1997
Rinconada	17.0 km	East	Uniform Building Code, 1997
San Gregorio (Sur Region)	19.0 km	Southwest	Uniform Building Code, 1997
Zayante-Vergeles	31.5 km	Northeast	Uniform Building Code, 1997
San Andreas (Parajo)	37.25 km	Northeast	Uniform Building Code, 1997

The new apartment complex buildings and any future building additions must be designed in strict compliance with the 2016 California Building Code, or current edition, to help withstand such seismically generated ground accelerations for a reasonably expected duration without suffering major damage.

The following are the project site coordinates and the seismic design criteria/coefficients per the requirements of the 2016 California Building Code (CBC):

Site Class	Latitude	Longitude	S _s	S ₁	F _a	F _v
D	36.5738°	-121.8070°	1.455	0.528	1.00	1.50

Frame and semi-rigid structures with proper strengthening connections and hold-down fasteners (where needed) are recommended for the new apartment complex and any future building additions. With proper design parameters, seismic damage to the building can be mitigated for major earthquakes centered near the project area.

Surface rupture, liquefaction, lurch cracking, lateral spreading, and differential settlement are seismic hazards that must be considered at the project site. Surface rupture usually occurs along fault lines, and no known faults have been mapped through the project site. Therefore, the potential for surface rupture or lurch cracking is considered to be low.

Liquefaction and lateral spreading tend to occur in loose, fine saturated sands and in places where the liquefied soils can move toward a free face (e.g. a cliff or ravine). The deeper soils underlying the project site are typically dense to very dense, silty, slightly clayey sandy soils. No ground water was encountered in the borings to a maximum depth of 25.0 feet. Considering the deeper, dense to very dense, silty, slightly clayey, sandy soils and lack of groundwater present, the potential risk for occurrence of damaging liquefaction or lateral spreading is considered to be low during a strong seismic event.

Differential compaction and settlement occur generally in loose, granular or unconsolidated semi-cohesive soils during severe ground vibration. In our opinion, the risk for soil consolidation caused differential compaction and settlement during a major seismic event is considered to be low.

X. UNFORESEEN OR UNUSUAL CONDITIONS:

If any unforeseen or unsuitable soils conditions are found during grading or construction the Geotechnical engineer shall be notified immediately so that remedial action can be taken. Such unsuitable conditions could be:

1. Wet, soft or unsuitable pockets of clayey soil within the proposed building site.
2. Soil with a high organic content at the finished subgrade of the building pads.
3. Any other unforeseen conditions that would require remedial action by the Geotechnical engineer, project engineer, architect or contractor.

XI. CONCLUSIONS AND RECOMMENDATIONS:

From our field observations, analysis of the test data, and knowledge of the general area soils, the following are concluded:

1. The project soil conditions are suitable for the proposed new apartment complex, provided all loose near surface soil is recompacted prior to excavating for the new building foundations or finishing the subgrade of the building pads as recommended in Sections V and VIII herein.
2. Design criteria for a spread footing foundation system are provided in Sections IV and V. Design criteria for any proposed or future retaining walls are provided in Section VII. Design criteria for concrete slabs-on-grade are provided in Sections IV, V and IX herein.
3. Surface storm water runoff should be carefully controlled around the proposed building pads and foundations to provide positive drainage away from any building foundations as discussed in Section VI herein.
4. The Geotechnical engineer should review the building and site grading plans for compliance with the recommendations herein and may provide additional specific recommendations for surface or subsurface drainage. The Geotechnical engineer shall inspect and approve all new foundation footing excavations.
5. Grading, compaction specifications, pavement design criteria, and specifications for new concrete floor slabs-on-grade are provided in Section VIII herein.

6. Seismic considerations are discussed, and geoseismic design coefficients are provided in Section IX herein per the 2016 CBC. The potential for damaging earthquake related liquefaction is considered to be low at the project site.

XII. LIMITATIONS:

This report necessarily assumes that the subsurface conditions are as found in the borings. It should be recognized that the soil conditions described in this report are based on four borings and our knowledge of the general area soils. It must be understood that subsurface soil conditions can vary between borings and from site to site. If any unusual soil conditions are found during grading, installation of underground utilities or building construction, the Geotechnical engineer should be notified immediately so that remedial action can be taken (see Section X).

This report is issued with the understanding that it is the responsibility of the Owners or their representative to ensure that the applicable provisions of the recommendations contained herein are incorporated into the plans and specifications and that the necessary steps are taken to see that contractors and subcontractors carry out such provisions in the field. The use of this report, its contents or any part thereof, by a party or its agents, other than McIntosh Enterprises, their engineer, architect, contractor or designated agents, is hereby disallowed unless specific permission is given to do so by Soil Surveys Group, Inc. This investigation and report were prepared with the understanding that a proposed new apartment complex is to be constructed as shown on the Figure II map enclosed herein. The use of this report, boring logs and laboratory test data shall be restricted to the original use for which they were prepared and publication by any method, in whole or in part, is prohibited without the written consent of Soil Surveys Group, Inc. Title to the designs remains with Soil Surveys Group, Inc. without prejudice. Visual contact with this report and drawings constitutes prima facie evidence of the acceptance of these restrictions.

Soil Surveys Group, Inc. will not take responsibility for or assume any liability for the recommendations made in this report unless Soil Surveys Group, Inc. performs the field inspections and testing mentioned herein.

The findings and recommendations of this report are considered valid at the present date. However, changes in the property conditions can occur with the passage of time on this or adjacent properties, whether due to natural processes or the works of man. Therefore, the findings of this report shall be considered valid for a period of not more than three years without being reviewed and updated by Soil Surveys Group, Inc.

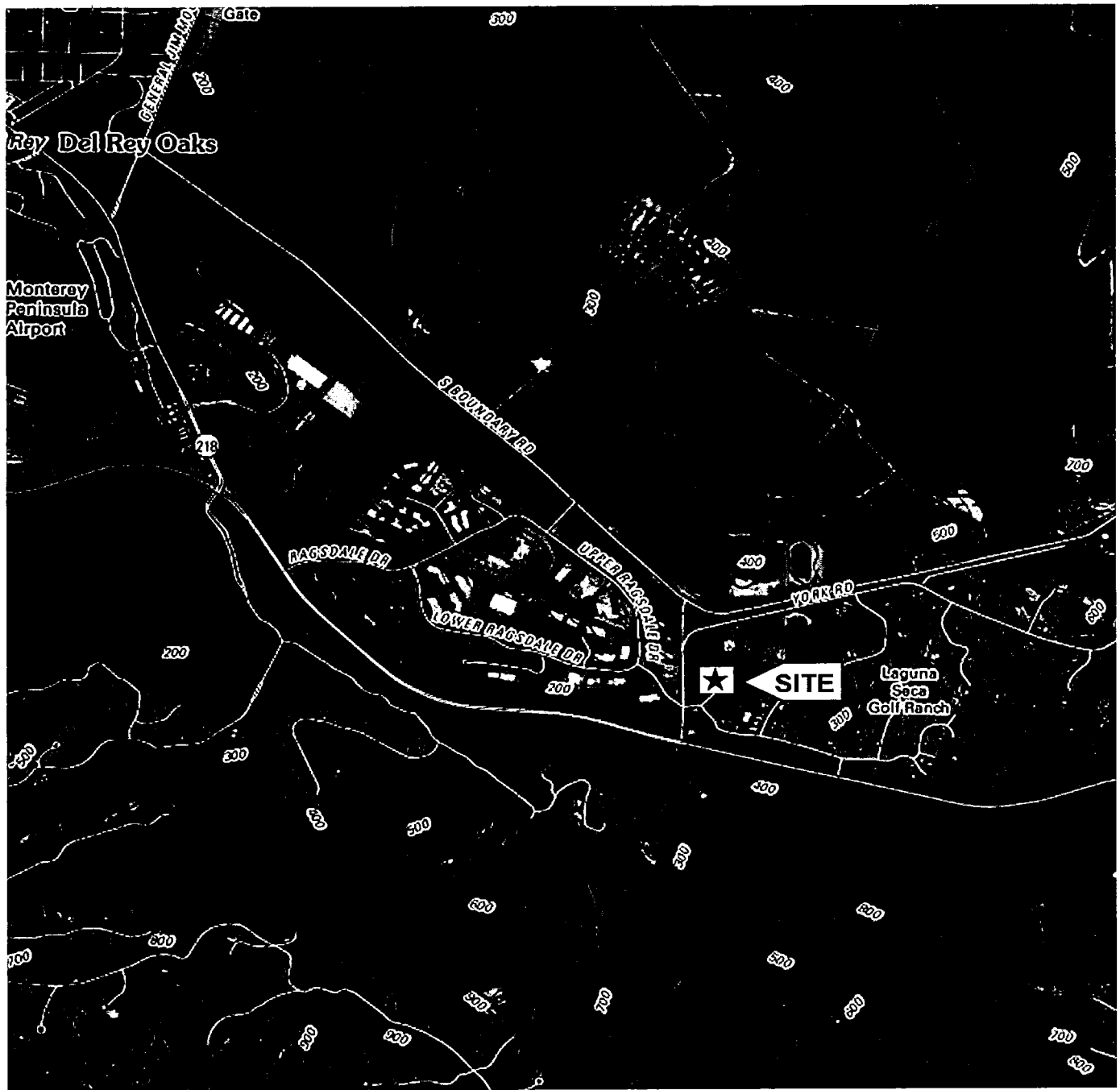

BASE: U.S. Geological Survey, Seaside
7.5' Quadrangles, Monterey, CA

FIGURE I: VICINITY MAP

SCALE
1" = 2000'

By: Soil Surveys Group, Inc.
103 Church Street
Salinas, CA 93901
831-757-2172



PLAN NORTH
NEW SITE PLAN
 SCALE: 1/8"=1'-0"

BASE: 24491 Citation Court, Lot 5, Laguna Seca, Monterey, California
 APN: 173-121-005
 Site Plan by Wald Ruhnke & Dost Architects, LLP. January 2018- Job #7044

KEY NOTES

- THE KEY NOTES THAT FOLLOW APPLY TO THE DRAWING(S) ON THIS SHEET ONLY. REFER TO FOLLOWING SHEETS FOR NOTES THAT ARE APPLICABLE TO THOSE DRAWINGS.
- 1 INDICATES PROPERTY LINE
 - 2 (E) CONCRETE CURB AND WALKWAY TO REMAIN INTACT.
 - 3 (E) ASPHALT PAVED COUNTY ROAD TO REMAIN INTACT.
 - 4 (E) TREE TO REMAIN INTACT. PROTECT FROM DAMAGE.
 - 5 (E) STREET LIGHT TO REMAIN INTACT. PROTECT FROM DAMAGE.
 - 6 (E) UTILITY VAULT TO REMAIN INTACT. PROTECT FROM DAMAGE.
 - 7 (E) RETAINING WALL AROUND UTILITY VAULT TO REMAIN INTACT. PROTECT FROM DAMAGE.
 - 8 INDICATES REQUIRED SETBACK LINE.
 - 9 HATCH AREA INDICATES EASEMENT.
 - 10 4" WIDE PAINTED PARKING STALL STRIPING PER COUNTY STANDARDS.
 - 11 PROVIDE 4" THICK CONCRETE WALKWAY WITH SLIP RESISTANT FINISH (MEDIUM SALT FINISH, TYP.) AND PROPERLY PLACED #3X710X10 WELDED WIRE MESH OVER A MIN. 6" CLASS 2 AGGREGATE BASE WORK OVER COMPACTED SUBGRADE. CONCRETE WALK TO BE A MIN. 4" WIDE (SEE PLAN DIMENSION FOR SPECIFIC CONDITIONS). PROVIDE POSITIVE SLOPE AWAY FROM BUILDING WHERE APPLICABLE. REFER TO CIVIL DRAWINGS AND GEOTECH REPORT FOR EXACT CONFIGURATION OF CONCRETE WALKWAY SECTION. SEE DETAIL 15A110.
 - 12 PROVIDE DETECTABLE WARNING SURFACE (TRUNCATED DOMES) MIN. 36" IN DEPTH THE ENTIRE LENGTH OF OPENING / LANDING / RAMP AS SHOWN ON PLAN. SEE DETAIL 8A110.
 - 13 LANDSCAPED AREA.
 - 14 PROVIDE PAINTED DIRECTIONAL ARROWS PER COUNTY STANDARDS. SEE DETAIL 11A110.
 - 15 INDICATES NEW BOARD FORMED INTEGRAL COLORED CONCRETE RETAINING WALL. - SEE CIVIL DRAWINGS.
 - 16 INDICATES "VAN ACCESSIBLE" STALLS. SEE DETAIL 8A110.
 - 17 INDICATES 36" BUMPER OVERHANG.
 - 18 INDICATES EXTENT OF 6" HIGH CURBS WHICH SHALL BE PAINTED RED WITH 4" HIGH WHITE LETTERS STATING "FIRE LANES - NO PARKING" AT 30" O.C. MAX. WHEN 6" CURBS NOT AVAILABLE, INSTALL A "FIRE LANES - NO PARKING ANYTIME" SIGN (R28 - 12"x18"). SIGN HEIGHT SHALL BE 54" FROM TOP OF PAVEMENT/LANDSCAPE AREA TO BOTTOM OF SIGN ON A WALL, FENCE OR BUILDING 35" O.C. MAX. A POLY-MOUNTED SIGN IN A PEDESTRIAN WALKWAY SHALL BE 64" FROM THE BOTTOM OF THE SIGN TO TOP OF WALKWAY. SEE DETAIL 50A110.
 - 19 INDICATES NEW BUILDING FOOTPRINT.
 - 20 INDICATES GROOVE BORDER. SEE DETAIL 7A110.
 - 21 ACCESSIBLE PATH OF TRAVEL INDICATOR ARROWS. ARROWS SHOWN ON PLAN ARE FOR REFERENCE ONLY AND NOT FOR PHYSICAL APPLICATION. WALKWAY ALONG ACCESSIBLE PATH OF TRAVEL SHALL BE CONTINUOUSLY ACCESSIBLE. HAVE A MAX. 1/2" CHANGE IN ELEVATION. MIN. 48" IN WIDTH. HAVE MAX. 1/4" PER FOOT CROSS SLOPES, AND WHERE NECESSARY TO CHANGE ELEVATION AT A SLOPE EXCEEDING 5% (1:20) SHALL HAVE RAMPS COMPLYING WITH CBC SECTION 11338.7.
 - 22 INDICATES LOCATION OF METAL TUBE BIKE RACK, MIN. (8) BIKE CAPACITY. SEE DETAIL 12A110.
 - 23 PROVIDE CONCRETE WHEEL STOP. SEE DETAIL 8 & 10A110.
 - 24 PROVIDE A "DISABLED PARKING ENTRY" SIGN ("VEHICLE TOW-AWAY" SIGN) (17"x22") AND A "NOTICE ALL ROADS ARE FIRE LANES" ENTRANCE SIGN (17"x21") INSTALLED TOGETHER FOR VEHICLES ENTERING INTO THE PARKING LOT AT ALL DRIVEWAY ENTRANCES PER COUNTY STANDARDS. SEE DETAIL 50A110.
 - 25 PROVIDE ACCESSIBLE STALL SIGNAGE. SEE DETAIL 9A110.
 - 26 PROVIDE 6" HIGH CONCRETE CURB TYPICAL AS SHOWN. REFER TO CIVIL DRAWINGS FOR ADDITIONAL NOTATION.
 - 27 PROVIDE NEW AG PAVEMENT OVER AGGREGATE BASE AND COMPACTED SOIL SUBGRADE. REFER TO CIVIL DRAWINGS FOR ADDITIONAL NOTATION.
 - 28 INDICATES NEW ACCESSIBLE CURB RAMP PER ADA AND COUNTY STANDARDS. PROVIDE TRUNCATED DOME DETECTABLE WARNING SURFACE AS REQUIRED. PROVIDE PAINTED INTERNATIONAL SYMBOL OF ACCESSIBILITY.
 - 29 INDICATES CONCRETE CONTROL OR EXPANSION JOINTS AT CONCRETE WALKWAY. SEE DETAIL 14A110.
 - 30 PROVIDE R1 STOP SIGN (24"x24") AT ALL DRIVEWAY EXITS FOR EXITING VEHICLES FROM PARKING LOT PER COUNTY STANDARDS.
 - 31 EXTERIOR WALKWAY AND DOOR LANDINGS SHALL NOT EXCEED 1/4" PER FOOT (2") UP TO DOORS THRESHOLD FOR A MIN. DISTANCE OF 5'-0" OUT FROM THE DOOR OPENING. TYPICAL AT ALL EXTERIOR DOORS (I.O.D.).
 - 32 PROVIDE NEW CONCRETE GUTTER / CURB / WALKWAY PER COUNTY PUBLIC WORKS STANDARDS.
 - 33 INDICATES NEW 6'-0" BOARD FORMED INTEGRAL COLORED CONCRETE TRANSITORY ENCLOSURE WITH FRAMED AND PAINTED METAL ACCESS GATES. SEE DETAIL 20A111.

WR&D
 WALD RUHNKE & DOST
 ARCHITECTS LLP
 2340 GARDEN ROAD, SUITE 100
 MONTEREY, CALIFORNIA 93940
 PHONE: 831.549.4512
 FAX: 831.549.3530
 WWW.WR&DARCH.COM

THE USE OF THE PLANS AND SPECIFICATIONS IS LIMITED TO THE PROJECT AND SITE SHOWN HEREON. ANY REUSE OF THESE PLANS AND SPECIFICATIONS FOR OTHER PROJECTS WITHOUT THE WRITING OF WR&D ARCHITECTS LLP IS STRICTLY PROHIBITED. THE USER SHALL BE RESPONSIBLE FOR OBTAINING ALL NECESSARY PERMITS AND APPROVALS FROM THE APPROPRIATE AGENCIES. WR&D ARCHITECTS LLP SHALL NOT BE RESPONSIBLE FOR ANY DAMAGE TO PERSONS OR PROPERTY ARISING FROM THE USE OF THESE PLANS AND SPECIFICATIONS.

LOT 5
 LAGUNA SECA APARTMENTS

MAINTOSH ENTERPRISES
 173-121-005
 MONTEREY, CA 93940

A.P.N. NO.: 173-121-005

FIGURE II
 Boring Locations (approx.)

By: **Soil Surveys Group, Inc.**
 103 Church Street
 Salinas, CA 93901
 ph. 831-757-2172
 fax 831-755-7330
 email: info@soilsurveys.net

APPENDIX A

BORING LOGS

PRIMARY DIVISIONS			GROUP SYMBOL	SECONDARY DIVISIONS
COARSE GRAINED SOILS MORE THAN HALF OF MATERIAL IS LARGER THAN NO. 200 SIEVE SIZE	GRAVELS MORE THAN HALF OF COARSE FRACTION IS LARGER THAN NO. 4 SIEVE	CLEAN GRAVELS (LESS THAN 5% FINES)	GW	Well graded gravels, gravel-sand mixtures, little or no fines.
		GRAVEL WITH FINES	GP	Poorly graded gravels or gravel-sand mixtures, little or no fines.
			GM	Silty gravels, gravel-sand-silt mixtures, non-plastic fines
		GC	Clayey gravels, gravel-sand-clay mixtures, plastic fines.	
	SANDS MORE THAN HALF OF COARSE FRACTION IS SMALLER THAN NO. 4 SIEVE	CLEAN SANDS (LESS THAN 5% FINES)	SW	Well graded sands, gravelly sands, little or no fines.
			SP	Poorly graded sands or gravelly sands, little or no fines.
		SANDS WITH FINES	SM	Silty sands, sand-silt mixtures, non-plastic fines.
			SC	Clayey sands, sand-clay mixtures, plastic fines.
FINE GRAINED SOILS MORE THAN HALF OF MATERIAL IS SMALLER THAN NO. 200 SIEVE SIZE	SILTS AND CLAYS LIQUID LIMIT IS LESS THAN 50%		ML	Inorganic silts and very fine sands, rock flour, silty or clayey fine sands or clayey silts with slight plasticity.
			CL	Inorganic clays of low to medium plasticity, gravelly clays, sandy clays, silty clays, lean clays.
			OL	Organic silts and organic silty clays of low plasticity.
	SILTS AND CLAYS LIQUID LIMIT IS GREATER THAN 50%		MH	Inorganic silts, micaceous or diatomaceous fine sandy or silty soils, elastic silts
			CH	Inorganic clays of high plasticity, fat clays.
			OH	Organic clays of medium to high plasticity, organic silts.
HIGHLY ORGANIC SOILS			Pt	Peat and other highly organic soils.

GRAIN SIZES

U.S. STANDARD SERIES SIEVE

CLEAR SQUARE SIEVE OPENINGS

200

40

10

4

3/4"

3"

12"

SILTS AND CLAYS	SAND			GRAVEL		COBBLES	BOULDERS
	FINE	MEDIUM	COARSE	FINE	COARSE		

RELATIVE DENSITY

SANDS AND GRAVELS	BLOWS/FT*
VERY LOOSE	0 - 4
LOOSE	4-10
MEDIUM DENSE	10 - 30
DENSE	30 - 50
VERY DENSE	OVER 50

CONSISTENCY

SILTS AND CLAYS	STRENGTH**	BLOWS/FT*
VERY SOFT	0 - 1/4	0 - 2
SOFT	1/4 - 1/2	2 - 4
FIRM	1/2 - 1	4 - 8
STIFF	1 - 2	8 - 16
VERY STIFF	2 - 4	16 - 32
HARD	OVER 4	OVER 32

*Number of blows of 140 pound hammer falling 30 inches to drive a 2 inch O.D. (1 3/8 inch I.D.) split spoon (ASTM D-1586)

**Unconfined compressive strength in tons/ft² as determined by laboratory testing or approximated by the standard penetration test (ASTM D-1586), pocket penetrometer, torvane, or visual observation

FIGURE NO. KEY TO LOGS

EXPLORATION DRILL LOG

HOLE NO. B-1

PROJECT McIntosh Enterprises, 24491 Citation Court, Monterey Job #7044

DATE 1.23.18

LOGGED BY JG

DRILL RIG Cenozic Crawler

HOLE DIA. 5"

SAMPLER Terzaghi Split Spoon (SPT) + 2.5" CAL

GROUNDWATER DEPTH:

INITIAL ---

FINAL ---

HOLE ELEV. ---

DESCRIPTION	SOIL TYPE	DEPTH	SAMPLE	BLOWS PER FOOT	DRY DENSITY (pcf)	WATER CONTENT %	LIQUID LIMIT	PLASTIC LIMIT	POCKET PEN. (tsf)
Grasses/ Dark brown, silty, fine to medium grained SAND with organics and clay; moist, loose	SM								
Dark greyish brown slightly clayey, silty, fine to medium grained SAND with organics; very moist, very loose	SM/SC	1	SPT						
		2	XXX	3	76.4	16.6	19	15	---
		3							
		4							
Light greyish-tan, slightly clayey, silty, fine to medium grained, weakly cemented SAND; moist to wet, dense	SM	5	SPT						
Light greyish-tan, silty, clayey, fine to medium grained SAND with thin veins of dark clay; moist, medium dense	SC/CL	6	XXX 2.5" CAL	38	116.5	12.9			0.5
		7	XXX	30(18)	112.1	14.6	33	13	>4.5
		8	XXX	48(29)	100.5	23.7	Shear	Test	>4.5
Dark brown, silty, clayey, fine to coarse grained SAND with scattered fractured decomposed granitic gravels; moist, dense	SC/CL	9	SPT						
		10	XXX	36	104.7	13.6			1.75
		11							
		12							
		13							
Light tan, silty, clayey, fine to medium grained SAND with thin veins of grey clay and subrounded gravels; moist, dense	SC	14	SPT						
		15	XXX	37	104.9	13.4			3.75
		16							
		17							
		18							
Reddish-yellow-tan, slightly clayey, silty, fine to coarse grained SAND with fractured siliceous shale gravels; moist, dense	SM	19	SPT						
		20	XXX	40	93.2	11.7			---

DEPTH 25'

SOIL SURVEYS GROUP, INC

EXPLORATION DRILL LOG

HOLE NO. B-1 CONTINUED

DESCRIPTION	SOIL TYPE	DEPTH	SAMPLE	BLOWS PER FOOT	DRY DENSITY (pcf)	WATER CONTENT %	LIQUID LIMIT	PLASTIC LIMIT	POCKET PEN. (tsf)
Reddish-yellow-tan, slightly clayey, silty, fine to coarse grained SAND with fractured siliceous shale gravels; moist, dense	SM	21							
		22							
		23							
Light tan, silty, fine to coarse grained SAND with scattered fractured shale gravels and veins of dark brown, silty, sand; slightly moist, very dense	SM	24	SPT						
Bottom of the boring at 25'	SM	25	XXX	51	100.1	8.9			---
		26							
		27							
		28							
		29							
		30							
		31							
		32							
		33							
		34							
		35							
		36							
		37							
		38							
		39							
		40							
		41							
		42							

DEPTH 25'

Job #7044

SOIL SURVEYS GROUP, INC.

EXPLORATION DRILL LOG

HOLE NO. B-2

PROJECT McIntosh Enterprises, 24491 Citation Court, Monterey Job #7044

DATE 1.23.18

LOGGED BY JG

DRILL RIG Cenozic Crawler

HOLE DIA. 5"

SAMPLER Terzaghi Split Spoon (SPT) + 2.5" CAL

GROUNDWATER DEPTH:

INITIAL ---

FINAL ---

HOLE ELEV. ---

DESCRIPTION	SOIL TYPE	DEPTH	SAMPLE	BLOWS PER FOOT	DRY DENSITY (pcf)	WATER CONTENT %	LIQUID LIMIT	PLASTIC LIMIT	POCKET PEN. (tsf)
Grasses/Dark reddish-brown, slightly clayey, slightly silty, fine to medium grained SAND with organics.	SM	1	SPT						
Light reddish-tan, silty, fine micaceous SAND; moist, loose		2	XXX	5	76.3	4.7	n/p	n/p	---
Light reddish-tan, dark brown, silty, fine to medium grained SAND; moist, loose to medium dense	SM	3	2.5" CAL						
		4	XXX	12(7)	103.7	4.1			1.0
			XXX	18(11)	99.8	2.6			1.0
Light reddish-tan, slightly silty, fine to medium grained SAND; moist, medium dense	SM	5	SPT						
		6	XXX	14	101.4	3.1			---
		7							
		8							
Light reddish-yellowish-tan, light tan, slightly silty, fine to medium grained SAND with thin veins of clay; moist, very dense	SM/SP	9	SPT						
		10	XXX	65	100.7	9.9			---
		11							
		12							
		13							
Light reddish-tan, silty, fine to medium grained SAND; moist to wet, very dense	SM	14	SPT						
		15	XXX	90	107.0	10.5			---
		16							
		17							
		18							
Light yellowish-tan, slightly silty, fine to medium grained SAND; wet, very dense	SM/SP	19	SPT						
Bottom of the boring at 20'	SM/SP	20	XXX	95	114.5	14.2			---

DEPTH 20'

SOIL SURVEYS GROUP, INC

EXPLORATION DRILL LOG

HOLE NO. B-3

PROJECT McIntosh Enterprises, 24491 Citation Court, Monterey Job #7044 DATE 1.23.18 LOGGED BY JG

DRILL RIG Cenozic Crawler HOLE DIA. 5" SAMPLER Terzaghi Split Spoon (SPT)

GROUNDWATER DEPTH: INITIAL --- FINAL --- HOLE ELEV. ---

DESCRIPTION	SOIL TYPE	DEPTH	SAMPLE	BLOWS PER FOOT	DRY DENSITY (pcf)	WATER CONTENT %	LIQUID LIMIT	PLASTIC LIMIT	POCKET PEN. (tsf)
Grasses/ Dark brown, clayey, silty, fine to coarse grained cemented SAND with scattered gravels		1							
Light brown, clayey, silty, fine to coarse grained cemented SAND with scattered subrounded to subangular gravels; moist, dense	SM/SC	2	SPT						
		3	XXX	36	92.7	8.1			>4.5
Dark brown, light tan, clayey, silty, fine to coarse cemented SAND with scattered fine gravels; slightly moist, very dense	SM/SC	4	SPT						
		5	XXX	64	99.6	9.6	32	13	>4.5
Light reddish-brown, light reddish-yellow, clayey, silty, fine to coarse grained weakly cemented SAND; slightly moist, medium dense	SM	6	SPT						
		7	XXX	28	92.7	16.3			>4.5
		8							
Light brown, silty, clayey, fine to coarse grained SAND; slightly moist, dense	SC/CL	9	SPT						
		10	XXX	45	105.1	12.7			>4.5
		11							
		12							
		13							
Light yellowish-tan, slightly silty, fine to medium grained SAND; moist, medium dense	SM	14	SPT						
Light yellowish-tan, whitish-tan, silty, clayey, cemented fine to coarse grained SAND; moist, medium dense	SC/SM	15	XXX	25	88.1	12.4			2.0
		16							
		17							
		18							
Light yellowish-tan, slightly silty, fine to medium grained weakly cemented SAND; moist, dense	SM/SP	19	SPT						
Bottom of the boring at 20'	SM/SP	20	XXX	40	101.5	6.6			---

DEPTH 20'

SOIL SURVEYS GROUP, INC

EXPLORATION DRILL LOG

HOLE NO. B-4

PROJECT McIntosh Enterprises, 24491 Citation Court, Monterey Job #7044

DATE 1.23.18

LOGGED BY JG

DRILL RIG Cenozic Crawler

HOLE DIA. 5"

SAMPLER Terzaghi Split Spoon (SPT)

GROUNDWATER DEPTH:

INITIAL ---

FINAL ---

HOLE ELEV. ---

DESCRIPTION	SOIL TYPE	DEPTH	SAMPLE	BLOWS PER FOOT	DRY DENSITY (pcf)	WATER CONTENT %	LIQUID LIMIT	PLASTIC LIMIT	POCKET PEN. (tsf)
Grasses/ Dark brown, silty, fine to medium grained SAND with organics; moist, loose	SM	1							
Light brown, light greyish-tan, silty, fine to medium grained cemented SAND; moist, medium dense	SM	2	SPT						
			XXX	14	84.4	7.6	n/p	n/p	1.0
		3							
Light greyish-tan, silty, fine to medium grained cemented SAND; slightly moist, medium dense	SM	4	SPT						
			XXX	27	104.8	4.4	n/p	n/p	---
		5							
Light reddish-tan, slightly silty, fine to medium grained SAND; moist, dense	SM/SP	6	SPT						
			XXX	41	101.5	10.6			1.0
		7							
		8							
Light reddish-yellowish-tan, fine to medium grained SAND; moist, very dense	SP	9	SPT						
			XXX	80	105.3	7.3			0.5
		10							
		11							
		12							
		13							
Light reddish-yellow-tan, fine to medium grained SAND; moist, dense	SP	14	SPT						
			XXX	44	105.2	5.3			0.25
		15							
		16							
		17							
		18							
Light tan, fine to medium grained SAND; moist, very dense	SP	19	SPT						
Bottom of the boring at 20'		20	XXX	53	101.1	5.8			1.0

DEPTH 20'

SOIL SURVEYS GROUP, INC

APPENDIX B

DIRECT SHEAR TEST



Consolidated Drained Direct Shear (ASTM D3080)

CTL Job #: 699-094 Project #: 7044 By: MD
 Client: Soil Surveys Inc Date: 2/6/2018 Checked: PJ
 Project Name: Laguna Seca Remolding Info:

Specimen Data				
	1	2	3	4
Boring:	B1	B1	B1	
Sample:				
Depth (ft):	7-7.5	7-7.5	7-7.5	
Visual Description:	Dark Gray Sandy CLAY w/ pockets Clayey Sand	Dark Gray Sandy CLAY w/ pockets Clayey Sand	Dark Gray Sandy CLAY w/ pockets Clayey Sand	
Normal Load (psf)	1000	3000	5000	
Dry Mass of Specimen (g)	121.8	120.1	124.0	
Initial Height (in)	1.01	1.00	1.01	
Initial Diameter (in)	2.42	2.42	2.42	
Initial Void Ratio	0.681	0.693	0.656	
Initial Moisture (%)	23.9	24.4	22.7	
Initial Wet Density (pcf)	124.2	123.8	124.9	
Initial Dry Density (pcf)	100.3	99.5	101.8	
Initial Saturation (%)	94.7	94.9	93.6	
ΔHeight Consol (in)	0.0054	0.0131	0.0224	
At Test Void Ratio	0.672	0.671	0.619	
At Test Moisture (%)	24.8	24.7	22.7	
At Test Wet Density (pcf)	125.8	125.8	127.7	
At Test Dry Density (pcf)	100.8	100.9	104.1	
At Test Saturation (%)	99.6	99.4	98.8	
Strain Rate (%/min)	0.01	0.01	0.01	
Strengths Picked at	Peak	Peak	Peak	
Shear Stress (psf)	1299	2153	3470	
ΔHeight (in) at Peak	-0.0050	0.0011	0.0027	
Ultimate Stress (psf)				

Phi (deg)	28.2	Ult. Phi (deg)	
Cohesion (psf)	650	Ult. Cohesion (psf)	

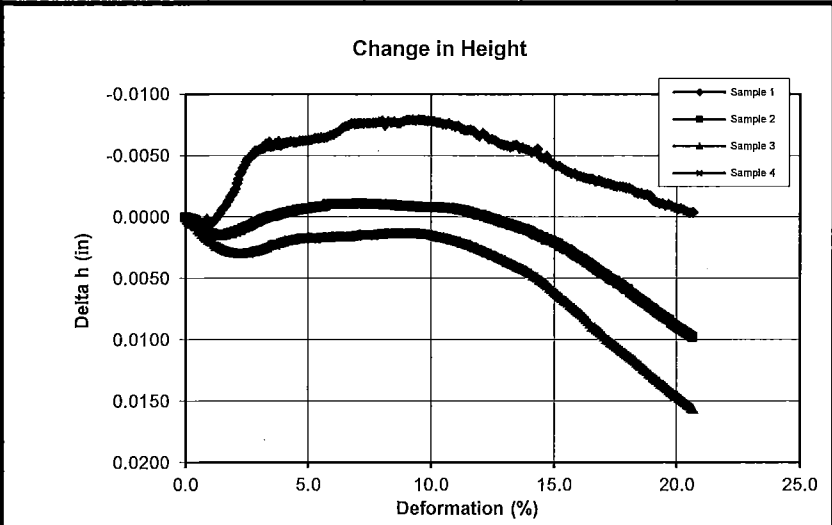
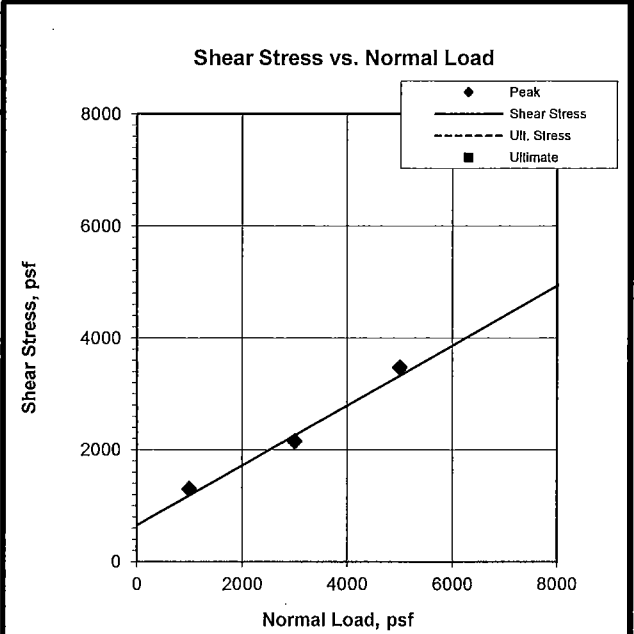
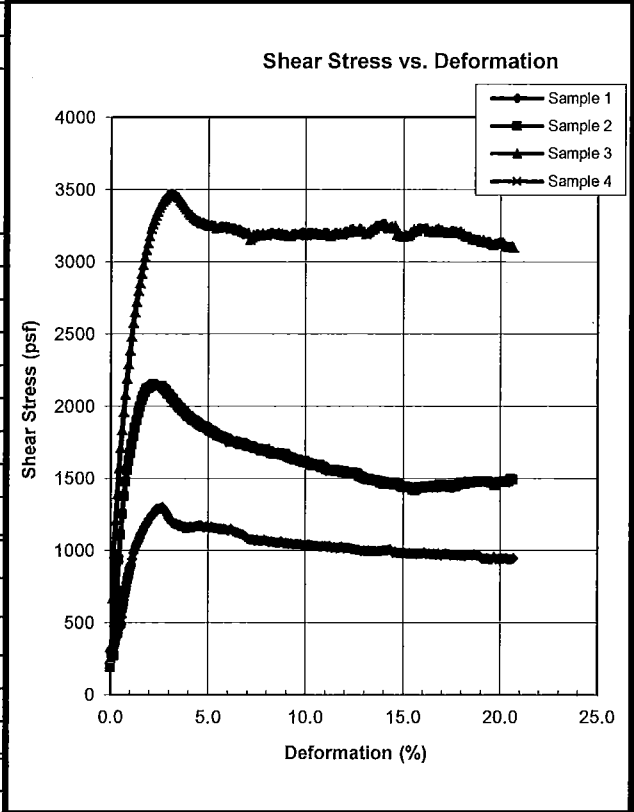

Remarks:

APPENDIX C

R-VALUE TEST



R-value Test Report (Caltrans 301)

Job No.: 699-099	Date: 02/08/18	Initial Moisture, <u>7.7</u>
Client: Soil Surveys Inc	Tested: PJ	R-value 62
Project: Laguna Seca - 7044	Reduced: RU	Expansion Pressure 0 psf
Sample: R-1; Composite	Checked: DC	
Soil Type: Dark Olive Brown Silty SAND		

Specimen Number	A	B	C	D	Remarks:
Exudation Pressure, psi	208	384	509		
Prepared Weight, grams	1200	1200	1200		
Final Water Added, grams/cc	50	45	39		
Weight of Soil & Mold, grams	3164	3069	3170		
Weight of Mold, grams	2097	2064	2113		
Height After Compaction, in.	2.54	2.34	2.45		
Moisture Content, %	12.1	11.7	11.2		
Dry Density, pcf	113.6	116.6	117.7		
Expansion Pressure, psf	0	0	0		
Stabilometer @ 1000					
Stabilometer @ 2000	42	34	32		
Turns Displacement	4.56	4.44	4.32		
R-value	61	64	70		

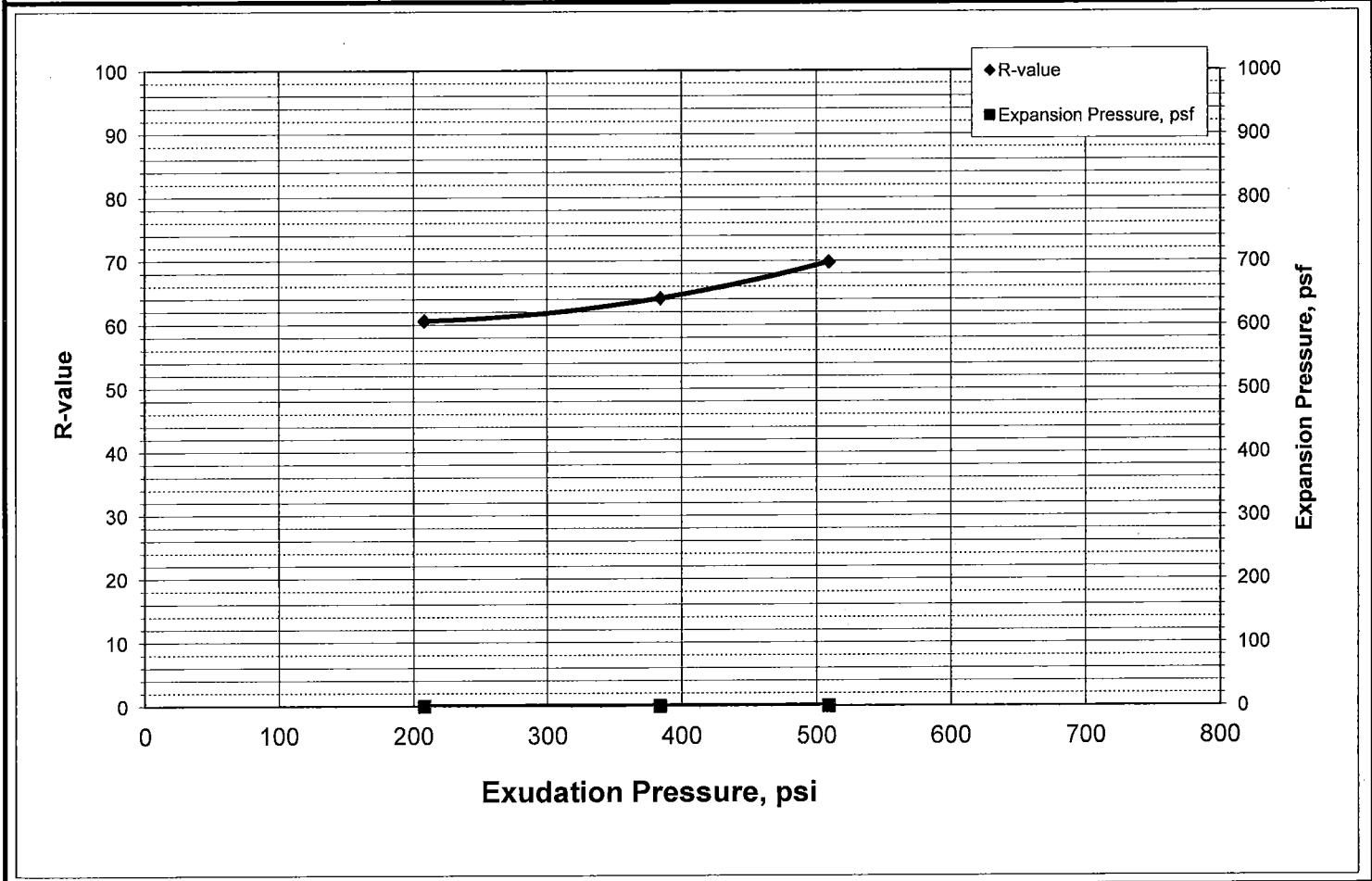

Laguna Seca Office Park
Lot 5

24491 Citation Court
Monterey, California 93940

Drainage Report
December 21, 2011
February 2, 2018 Update

Project No: 2085.45

Prepared by:



BESTOR ENGINEERS, INC.

CIVIL ENGINEERING — SURVEYING — LAND PLANNING
9701 BLUE LARKSPUR LANE, MONTEREY, CALIFORNIA 93940



BESTOR ENGINEERS, INC.

CIVIL ENGINEERING — SURVEYING — LAND PLANNING
9701 BLUE LARKSPUR LANE, MONTEREY, CALIFORNIA 93940
(831) 373-2941 • SALINAS 424-7681 • FAX 649-4118

Laguna Seca Office Park, Lot 5 Drainage Report

*December 21, 2011
February 2, 2018 Update*

Background

Laguna Seca Office Park is a 40-acre subdivision located off Highway 68 east of York Road in Monterey County. Lot 5, a 1.92-acre lot, lies on the northeast side of Citation Court, off Blue Larkspur Lane. The terrain is generally steep along the north, east and west sides of the property and drainage flows onto the along the center to a low point on the southeast end of the property, west of Citation Court.

The detention facilities for the subdivision were designed on the basis of a 10-year, 6-hour storm event¹. Drainage from Lot 5 was transferred via storm water piping down Citation Court to Pond A, located south of Blue Larkspur Lane. Pond A discharges to the Canyon Del Rey Creek, approximately five miles upstream from the creek outlet to the Pacific Ocean.

Design Criteria and Flow Calculations

Drainage requirements have changed since the development of the Laguna Seca Office Park. Current drainage guidelines require the detention of the differential volume between the 100-year, post-development runoff rate and the 10-year, pre-development runoff rate, therefore limiting the discharge to the 10-year pre-development rate. Given that Lot 5 is located in a subdivision with existing drainage facilities, a reduction will be applied to the required detention volume to account for the detention volume provided in the existing facilities.

The proposed stormwater piping system for Lot 5 is designed to convey the flow of a 25-year storm for the entire watershed area which includes the 1.92 acres of onsite drainage and the 2.69 acres of offsite watershed. Discharge piping has been designed to meter the rate of release to the 10-year pre-development rate for the site.

Design parameters used in Attachment A: Stormwater Storage Calculations and Attachment B: Stormwater Piping Calculations and are as follows:

Table 1: Time of Concentration

Design Storm	Time of Concentration (min)
10-year Pre-development	20
100-year Post-development	15
25-year (pipe sizing)	15
10-year & 100-year	30

¹ Final Drainage Report, prepared by Carl L. Hooper, PE, Bestor Engineers, Inc., February 3, 1986.

(Undeveloped offsite watershed)	
---------------------------------	--

Table 2: Runoff Coefficients

Land Use	Runoff Coefficient
Open or Landscaped	0.2
Building and Paved	0.95

Monterey County's Plate No. 25: Rainfall Intensities Chart was used in calculating the rainfall intensities. From the chart, a 0.6 in/hr intensity for a 2-year storm was used.

Table 3: Rainfall Intensities

Design Storm	Rainfall Intensities (in/hr)
10-year Pre-development	1.54
100-year Post-development	2.67
25-year (pipe sizing)	2.08
10-year (Undeveloped offsite watershed)	1.26
100-year (Undeveloped offsite watershed)	1.88

Using the parameters identified above, the following runoff rates were calculated for the site.

Table 4: Runoff Rate

Design Storm	Runoff Rate (cfs)
10-year Pre-development	0.59
100-year Post-development	2.92
10-year (Undeveloped offsite watershed)	0.68
100-year (Undeveloped offsite watershed)	1.01

Runoff rates for the individual stormwater pipes has been calculated and in shown on Attachment B: Stormwater Piping Calculations.

Detention Volume

Assuming a 1-hour storm event, the required detention volume is calculated as the difference between the 100-year post-development storm runoff and the 10-year pre-developed storm runoff, 5,025 c.f. as shown on Attachment A. A factor of 1.2 was applied to the calculation to account for nonlinearity of the actual hydrograph.

Existing drainage facilities for the subdivision were calculating using a 10-year, 6-hour storm event. Lot 5 was part of Watershed A, which totaled 16.1 acres. Prorating the detention

volume provided in Pond A, 0.25 acre-feet (10,890 c.f.) with our site area allows us to reduce the required storage by 1,306 c.f.

As shown on Attachment A: Stormwater Storage Calculations, a storage volume of 3,719 c.f. (27,821 gallons) will be required for onsite detention.

Conclusion

Due to site constraints, onsite detention is limited to underground storage. Two underground fiberglass tanks will be specified as part of the design, to provide a total of 30,000 gallons of storage, exceeding the required 27,821 gallon required detention volume. Discharge pipes are sized and sloped to meter to the runoff to the 10-year pre-development runoff rate. Freeboard has been calculated for onsite catch basins receiving runoff and shown to exceed required capacity requirements. The design includes an emergency overflow pipe sized to allow the release of the 100-year runoff the entire watershed draining into the site.

Stormwater quality is controlled with the use of a 1,000 gallon sediment tank for primary sediment control and an oil interceptor compartment specified as part of the first storage tank in the detention system, see attached schematic.

Laguna Seca Office Park - Lot 5

Attachment A

Stormwater Storage Calculations

Flow Calculation

$Q = CIA$

Q = Runoff C = Runoff Coefficient

$I_t = \text{Maximum Intensity: } I_t = (7.75 \cdot i) / (\text{sqrt}(T_c))$

$T_c = \text{Time of Concentration}$

$i = 1 \text{ hour rainfall intensity from Monterey County Rainfall Intensities Chart, Plate No 25: } i = 0.6$

Q₁₀

$A_{\text{pervious}} = 1.92 \text{ ac.}$

$T_c = 20 \text{ min (Assumed)}$

$C = 0.2$

$I_t = 1.54 \text{ in/hr}$

Q₁₀₀

$A_{\text{impervious}} = 0.87 \text{ ac.}$

$T_c = 15 \text{ min (Assumed)}$

$A_{\text{pervious}} = 1.05 \text{ ac.}$

$C = 0.95$

$A_{\text{total}} = 1.92 \text{ ac.}$

$I_t = 2.67 \text{ in/hr}$

Q₁₀ =	0.59 cfs
Q₁₀₀ =	2.76 cfs

Offsite Watershed Drainage	
$A_{\text{pervious}} = 2.69 \text{ ac.}$	$T_c = 30 \text{ min.}$
Q₁₀ = 0.68 cfs	Q₁₀₀ = 1.01 cfs

Storage Volume Calculation

$Q_{100} = Q_{\text{in}} = \text{Peak Inflow}$

$Q_{10} = Q_a = \text{Allowable Peak Outflow}$

$T_e = \text{Time of Event} = 60 \text{ min. (Assumed)}$

$V_s = \text{Storage Volume Required, ft}^3$

$V_p = \text{Storage Volume Provided in Existing Pond A} = 1306 \text{ ft}^3$

$K = \text{Factor to account for nonlinearity of actual hydrograph,}$

$K = 1.2$

$V_s = [(Q_{\text{in}} - Q_a) \times T_e \times (60\text{s/min}) \times 0.5 \times K] - V_p$

$V_s = V_r - V_p =$	4,693 - 1,306 =	3,387 ft³	25,334 gal.
---------------------------------------	------------------------	-----------------------------	--------------------

Estimated Required Storage Volume

NOTE: Graph does not account for the existing volume provided in Pond A

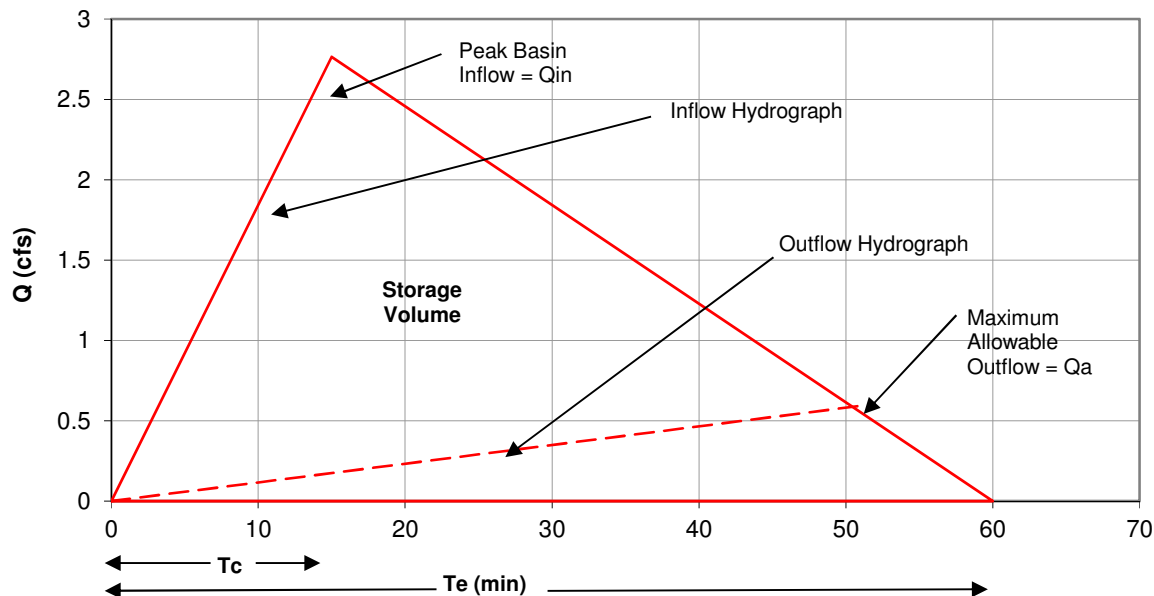

Keith Higgins

Traffic Engineer

February 12, 2018

Armando Guido-Lopez
Wald, Ruhnke & Dost Architects, LLP
2340 Garden Road, Suite 100
Monterey, CA 93940

Re: Laguna Seca Lot-5 Apartments Trip Generation Study, Monterey County, CA

Dear Armando,

As you requested, this is a trip generation study for the proposed Laguna Seca Lot-5 Apartments. The project involves the development of a 15-unit apartment on a 1.924-acre parcel designated for office development in the Laguna Seca Office Park in Monterey County, California. The "Final Environmental Impact Report – General Plan Amendment for the Laguna Seca Office Park Development," Scott Lefaver, March 1983 (1983 EIR), was certified by the County of Monterey. The proposed development included 27.8 acres of professional office park net land area plus two homes. The office park's building floor area was estimated to total 260,000 square feet. This is an average floor area ratio of 9,352 square feet per acre over the 27.8 acres. It should be noted that a 22,165-square foot office building was actually proposed for Lot 5. The traffic section of the 1983 EIR is included herein as Appendix A.

The original Office Park had traffic mitigations and development conditions that were satisfied allowing for development of the Park as individual parcels with office buildings (or residential as long as the gross square footage of the residential uses does not exceed the overall square footages of the office/commercial uses). The proposed apartment requires an amendment to the existing development permits, which includes ascertaining whether the current proposal will represent new traffic impacts. This is the purpose of this study, which determines if the current proposal will generate more trips than predicted in the 1983 EIR.

This study first summarizes the trip generation for the originally proposed office park as documented in the 1983 EIR. This estimate is then compared with a trip generation estimate using the current "Trip Generation Manual," Institute of Transportation Engineers (ITE), 10th Edition, 2017. The trip generation for Lot 5, the site of the proposed apartment, is then estimated for both the proposed apartment and for the site developed as the originally approved professional office.

1. Trip Generation Estimate for Originally Proposed Office Estimated in Original EIR

On page 68, paragraph 2, in Appendix A, Dryden and Nichol森, 1983 EIR traffic consultants, conservatively estimated that the Laguna Seca Office Park would generate between 3,120 and 3,900 daily trips. The project civil engineer, Carl Hooper, optimistically estimated that the project would have robust carpooling and transit usage that would reduce the net daily trip total to 2,550. Paragraph 6 of page 68 concludes that the project would generate between 2,500 and 3,900 trips per day. This is summarized in Section A of the trip generation spreadsheet on Attachment 1. Incidentally, I prepared the traffic study in 1982 when employed by William G. Dryden.

2. Trip Generation Estimate for Originally Proposed Office Park Using Current ITE Rates

Section B of Attachment 1 indicates that the originally proposed professional office land use would be expected to generate 2,700 daily trips, including 19 for the two single family homes included in the project. The office park would be expected to generate about 2,681 daily trips. The project is estimated to generate 303 AM peak hour trips and 284 PM peak hour trips. The daily total using current ITE rates is at the lower end of the range predicted in the 1983 EIR. Current ITE rates corroborate the trip generation estimate used in the EIR, which is actually higher by as much as 44%.

3. Trip Generation Estimate for Lot 5 as Apartments Compared With Office

Section C of Table 1 indicates that the proposed 15-unit apartment is expected to generate about 110 daily trips with 7 in the AM peak hour and 8 in the PM peak hour. Lot 5 has a land area of 1.924 acres. Assuming it could be developed with the average floor area ratio of the originally proposed 27.8 acre, 260,000-square foot office park, the site could accommodate a 17,993 square foot office building. Using standard ITE trip rates, the office building would be expected to generate about 186 daily trips with 21 in both the AM and PM peak hours. Section C indicates that the apartment building will generate about 76 less daily trips, 14 less AM peak hour trips and 12 less PM peak hour trips than expected from an office building. This is based on trip rates that would result in an estimate of 2,700 daily trips for the Office Park. The currently proposed apartments will generate far less traffic when compared to the conservative rates quoted in the 1983 EIR. As mentioned earlier, Lot 5 was actually proposed to include 22,165 gross square feet of office building. Again, the proposed 15-unit apartment building will generate far less traffic than what could actually be accommodated on Lot 5.

Armando Guido-Lopez
February 12, 2018

4. Conclusion and Recommendation

It is evident that the currently proposed apartments will generate less traffic than an office building with the square footage originally envisioned for Lot 5. The Office Park fulfilled its conditions of approval based on greater impacts than will actually occur for this parcel. On that basis there is no need for further study.

If you have any questions regarding this analysis, please do not hesitate to contact me at your convenience. Thank you for the opportunity to assist you with this project.

Sincerely,

Keith B. Higgins

Keith B. Higgins, PE, TE

enclosures

A. GENERATED TRIPS ESTIMATED IN 1983 EIR		
Laguna Seca Office Park EIR Daily Trip Generation Estimate (Pg 68, 2nd, 3rd and 5th paragraphs)	High Range	3,900
	Mid-Range	3,120
	Low Range	2,500
Source: Final Environmental Impact Report – General Plan Amendment for the Laguna Seca Office Park Development,” Scott Lefaver, March 1983, page 68		

B. GENERATED TRIPS BASED ON 2017 ITE RATES										
1. 2017 ITE Trip Generation Rates	ITE LAND USE CODE	DAILY TRIP RATE	<u>AM PEAK HOUR</u>				<u>PM PEAK HOUR</u>			
			PEAK HOUR RATE	% OF ADT	% IN	% OUT	PEAK HOUR RATE	% OF ADT	% IN	% OUT
			Single-Family Dwelling Unit (per unit)	210	9.44	0.74	8%	25%	75%	0.99
General Office (per 1,000 s.f. of gross floor area)	710	10.31	1.16	11%	86%	14%	1.15	11%	16%	84%
Multi-Family Housing (per dwelling unit)	220	7.32	0.46	6%	23%	77%	0.56	8%	63%	37%

2. Laguna Seca Office Park Trip Generation	PROJECT SITE	DAILY TRIPS	<u>AM PEAK HOUR</u>				<u>PM PEAK HOUR</u>			
			PEAK HOUR TRIPS	% OF ADT	TRIPS IN	TRIPS OUT	PEAK HOUR TRIPS	% OF ADT	TRIPS IN	TRIPS OUT
			Single-Family Dwelling Units	2 homes	19	1	5%	0	1	2
General Office	260,000 s.f.	2,681	302	11%	260	42	282	11%	45	237
TOTAL:		2,700	303		260	43	284		46	238

C. PROPOSED LOT-5 APARTMENT TRIP GENERATION COMPARISON WITH GENERAL OFFICE ALLOWANCE											
Laguna Seca Lot-5 Apartments	15	units	110	7	6%	2	5	8	8%	5	3
General Office - 1.924 acres	17,993	s.f.	186	21	11%	18	3	21	11%	3	17
Reduced Trip Generation from Apartments from General Office Allowance			(76)	(14)		(16)	2	(12)		2	(14)

Notes:

1. Trip generation rates from Institute of Transportation Engineers (ITE), *Trip Generation Manual*, 10th Edition, 2017, unless otherwise noted.
2. The Laguna Seca Office Park EIR General Office building area estimate of 260,000 square feet assumes a floor area ratio of 21.4%, or 9.352 gross square feet of building floor area per acre for the 27.8 acres of R-3 (Office) lots.

Appendix A
1983 EIR Excerpts

FINAL
ENVIRONMENTAL IMPACT REPORT
GENERAL PLAN AMENDMENT
FOR THE
LAGUNA SECA OFFICE PARK
DEVELOPMENT
BASE MAP #17

MARCH 1983

Prepared for:

County of Monterey Planning Department

KIR # 80-109

PC-3734 (REZONING)

PC-3834 (GENERAL PLAN AMMENDMENT)

SUBD 755

Prepared by:

Scott Lefaver, A.I.C.P

565 Chapman Court

Santa Clara, California 95050

CERTIFIED AS FINAL EIR BY
MONTEREY COUNTY BOARD OF
SUPERVISORS ON FEB 22 1983

FINAL
ENVIRONMENTAL IMPACT REPORT
GENERAL PLAN AMENDMENT
FOR THE
LAGUNA SECA OFFICE PARK
DEVELOPMENT
BASE MAP #17

MARCH 1983

LOAN COPY
PLEASE RETURN

Prepared for:

County of Monterey Planning Department

EIR # 80-109

PC-3734 (REZONING)

PC-3834 (GENERAL PLAN AMMENDMENT)

SUBD 755

Prepared by:

Scott Lefaver, A.I.C.P

565 Chapman Court

Santa Clara, California 95050

TABLE OF CONTENTS

SUMMARY	1
List of Figures	iii
List of Tables	iv
1.0 INTRODUCTION	6
1.1 Forward	6
1.2 Project Description	6
Site Location and Description	6
Background	8
Existing Improvements	8
Proposed Project Development	8
Residential	10
Commercial	10
Neighboring and Vicinity Land Use	10
1.3 Land Use and Planning	11
Planning Process, County of Monterey	11
County of Monterey, Applicable Plans and Policies	14
Monterey County General Plan	14
Historical Element	15
Circulation Element	15
Scenic Highway Element	15
Noise Element	16
Conservation/Open Space Element	16
Safety Element	17
Seismic Safety Element	17
General Development Plans for Laguna Seca Ranch	18
Other Applicable Plans and Policies	18
Monterey Peninsula Airport Master Plan	19
Monterey County Transportation Plan	19
Association of Monterey Bay Area Governments	19
Zoning	20
1.4 Project Economics	20
Economic Impact Upon the Monterey Area	20
2.0 ENVIRONMENTAL SETTING	21
2.1 Regional Setting	21

2.2	Regional Geology	21
	Regional Faulting	23
	Local Faulting	23
	Site Geology	26
	Seismic Hazards and Earthquake Potential	29
	Slope Stability	30
2.3	Soils.	33
2.4	Hydrology	36
	Surface Hydrology	36
	Groundwater	41
2.5	Biological Resources	49
	Vegetation	49
	Wildlife	51
2.6	Viewshed	54
2.7	Traffic	59
2.8	Air Quality	69
2.9	Noise and Airport Safety	72
2.10	Public Utilities	81
	Sanitary Sewer	81
	Water Service	85
	Fire Protection	87
	Police Protection	89
	Public Utilities	90
	Energy Conservation	90
2.11	Archaeology	91
3.0	ENVIRONMENTAL EVALUATION	92
	Cumulative Impacts	92
	Adverse Effects Which Cannot be Avoided if the Project is Implemented	100
	Alternatives	101
	No Project	101
	All Residential	102
	Higher Density	102

The Relationship between Local Short Term Uses of Man's Environment and the Maintenance and Enhancement of Long Term Productivity	101
3.5 Irreversible Environmental Changes Which Will be Involved in the Proposed Action Should it be Implemented	103
3.6 Growth Inducing Impacts	104
4.0 BIBLIOGRAPHY, PERSONS CONSULTED AND STAFF	105
4.1 Bibliography	105
Persons Consulted	106
Staff	107
5.0 APPENDICES	
Appendix A Initial Studies: County of Monterey	
Appendix B Geology	
Appendix C Groundwater Survey	
Appendix D Vegetative and Wildlife Species List	
Appendix E Noise Survey Location Map	
Appendix F Wastewater Reclamation System	
Appendix G Fiscal Impact Report	
Appendix H Comments in Response to Draft EIR	
Appendix I Response to Comments	
Appendix J Additional Comments by Public Works Department, County of Monterey	
Appendix K Comments on the County of Monterey's Newly Adopted General Plan	

LIST OF FIGURES

Figure 1	Regional Setting	7
Figure 2	Office Park Development Tentative Map	9
Figure 3	Project Site Vicinity	11
Figure 4	Existing Zoning	13
Figure 5	Local Vicinity Topography	22
Figure 6	Local Faulting	24
Figure 7	Regional Faulting	25
Figure 8	Site Geology	27
Figure 9	Geologic Cross Sections	28
Figure 10	Earthquake Intensity Zones	31
Figure 11	Soils	34
Figure 12	Drainage	38
Figure 13	Water Table Map	44
Figure 14	Vegetative Communities	52
Figure 15	Viewshed	55
Figure 16	1980 Peak Hour Traffic Volumes	60
Figure 17	Traffic Flow Map - Year 2000 Volumes Excluding Project Traffic	64
Figure 18	Year 2000 Peak Hour Volumes YorkRoad/Highway 68 Excluding Future Project Traffic	65

Figure 19	Traffic Flow Map 1980 Existing Volumes	66
Figure 20	Year 2000 Peak Hour Volumes - York Road/ Highway 68	67
Figure 21	Existing Noise Contours	73
Figure 22	Future Noise Conditions, ANCLUC Study	76
Figure 23	Proposed Sewage Facility	84
Figure 24	Regional Area Developments	95

LIST OF TABLES

Table 1	Uses Proposed for Office Park Development	10
Table 2	Geotechnical Hazards Identified at the Laguna Seca Ranch Subdivision Site	17
Table 3	Regional Faulting	23
Table 4	Groundwater in Storage in Laguna Seca Ranch	43
Table 5	Traffic Characteristics	61
Table 6	Mobile Source Emissions Generated by the Project	71
Table 7	Laguna Seca Ranch Noise dbA Readings	74
Table 8	Land Use Compatibility for Community Noise Environments: Outdoor Noise Levels	75
Table 9	Cumulative Impact Review: Hidden Hills Development	94
Table 10	Projected Water Use: Laguna Seca Watershed, Year 2000	99

1.2.2 Background

The proposed Office Park is owned by the Bishop, McIntosh and McIntosh partnership. A golf course adjacent to the Park is also owned by the partnership, but is under lease to Nick Lombardo. The school, 20 acres in the northwest corner, is owned by York School. Laguna Seca Ranch Estates No. 1, 46 lots on 39 acres near the southwest corner, is owned by 46 individuals or families, with appurtenant open space owned by a Home Owners Association. Laguna Seca Ranch Estates No. 2 (49 lots on 135 acres) was developed in 1980. Some lots in Unit 2 have been sold and several homes are under construction, however none have been occupied or completed as of August 1, 1982. The Laguna Seca Ranch was acquired by Frank Bishop in 1953; the subdivision was created in 1962, the York School in 1964, and the golf course in 1969. York Road, a 1500 foot long, 70 foot wide strip, is owned by the U.S. Government and is a part of Fort Ord.

1.2.3 Proposed Project Development

The proposed development consists of 260,000 square feet of office space located on 54 acres at the south westerly section of the Laguna Seca Ranch. The professional offices will include financial institutions and business offices to be developed on 19 lots ranging from .6 to 2.6 acres. The lots will be sold or leased for the construction of custom designed buildings. The Tentative Subdivision Map for this office park development is included as Figure 2.

The development also proposes two single family lots (20 and 21) to be located adjacent to the existing Ranch Estates No. 1. The probable gross office space (260,000 square feet) was calculated at an average of 20% ground coverage, with 10% designated as two story. Table 1 details the uses at the site.

Lots 1 through 19 are proposed for office and professional uses and two lots (20 and 21) for single family uses adjacent to the existing Laguna Seca Ranch Estates No. 1. The average size of the office park lots is 1.46 acres, the smallest of these lots being .66 acres. Lot 20 is proposed for .82 acres and Lot 21 for 1.08 acres for single family homes.

The site is accessed along the existing York Road to the proposed Blue Larkspur Lane. The area south of this roadway will remain as open space until such time as area for expansion of Highway 68 is needed. The highway entrance to Laguna Seca Ranch Estates will be closed upon construction of Blue Larkspur Lane from York Road. (Refer to Figure 2.)

LAGUNA SECA OFFICE PARK Office-Park Development Tentative Map

FIGURE 2

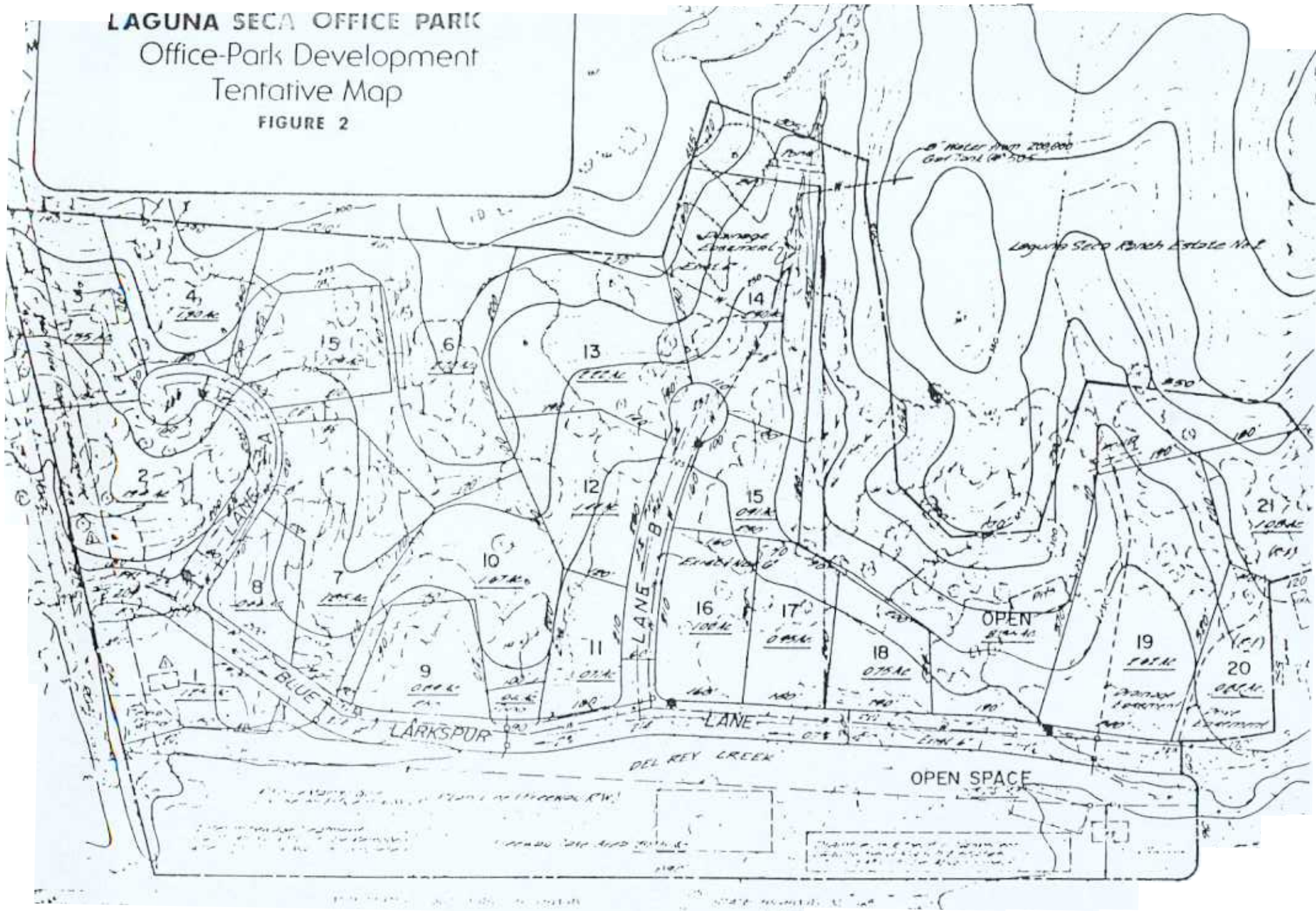

Table 1
Use Proposed for Office Park Development

Use	Net Acres	Percent
Roads	4.45	8.2
Common Drives	0.25	0.5
Freeway Take	8.85	16.1
Open Space	11.66	21.2
R-3 Lots (Office)	27.80	50.6
R-1 Lots (Single Family Homes)	1.40	3.5
TOTAL	54.91	100.0

1.2.4 Neighboring and Vicinity Land Use

The land in the vicinity of the project site, with its pastoral, semi-rural setting and attendant qualities (grassy meadows, oak groves, steep chaparral-covered slopes and pine forest), is a contrast to the urban city of Monterey. The area always has been a source of visual enjoyment for those passing by it on Highway 68, which was declared a Scenic Highway by the State of California in 1969.

The properties surrounding Laguna Seca Office Park are varied in their type and intensity of use. Generally, much of the land currently is undeveloped and/or in limited residential and agricultural use. However, there has been much planning activity on the part of landowners of the area, and there is evidence that substantial development could occur in the future.

The project site is within the former Monterey II Planning Area, located along the Highway 68 corridor. In March of 1976, the City of Monterey adopted its Monterey II Plan for this area. Based upon this plan a number of development proposals were prepared for almost 85% of the 8,300 acre Monterey II area over the last two decades. These proposals covered all of the 5 major land holdings in this area (Work Ranch, Lit Ng, Hidden Hills, Laguna Seca Ranch and Pebble Beach Corporation Properties). However, in November 1981 the people of the City of Monterey repealed the Monterey II Plan. Therefore, the future development of the surrounding area is unknown. Development can occur within the County as designated by the County's General Plan. No high intensity urban development can take

Street furniture, such as lamp posts, benches, litter containers, hydrants, plant containers, et cetera, shall be of a design compatible with the architecture and the character of the land and shall be consistent throughout the development.

All signs shall conform to an overall sign design concept coordinated through the entire development. This overall sign design concept will control color, shape, size and content of all signs. Symbols rather than words shall be used wherever possible.

Shingle roofs and/or tile stucco and natural wood siding exterior walls, arranged with particular attention to human size, shall dominate the architectural design of all buildings. Building complexes shall be designed to follow the existing slope of the land and be planned to minimize exposed earth cuts and fills and to preserve existing trees. In all cases, the forest shall take aesthetic precedence over structures and shall penetrate building complexes. Colors shall be selected from a recommended color palette. Color accents, in general, will be in doorways, windows, and on selected wall areas.

Exposed mechanical devices, such as radio and TV antennas, blowers, air conditioning devices, et cetera, will be minimized and blended. All utilities are to be underground.

Traffic and Circulation

Traffic Volumes

The following discussion is taken from traffic reports prepared for the area by William Dryden, Consulting Engineers and George W. Nickelson, P. E., Traffic Engineer.

Access to the project vicinity is provided by State Highway 68 (Monterey-Salinas Highway), which is a two-lane rural highway which runs in an east/west direction. It is the main traffic corridor between Salinas and Monterey. Current daily traffic volumes near the project site on Highway 68 average about 12,700 with peak hour volumes of approximately 1,250, based upon recent CalTrans counts summarized in Table 5 and illustrated in Figure 16. The peak hour level of service (L.O.S.) is D, with a volume to capacity (v/c) ratio of .67.

Additional access to the project vicinity is provided by State Highway 218 (Canyon del Rey Boulevard), which is a two-lane rural highway, in the vicinity of its intersection with Highway 68 -- approximately a half mile west of the Office Park. It provides service to State Highway 1 in Seaside via Del Rey Oaks. Average daily traffic (ADT) on Highway 218 is presently about 4800 near the junction of Highway 68.

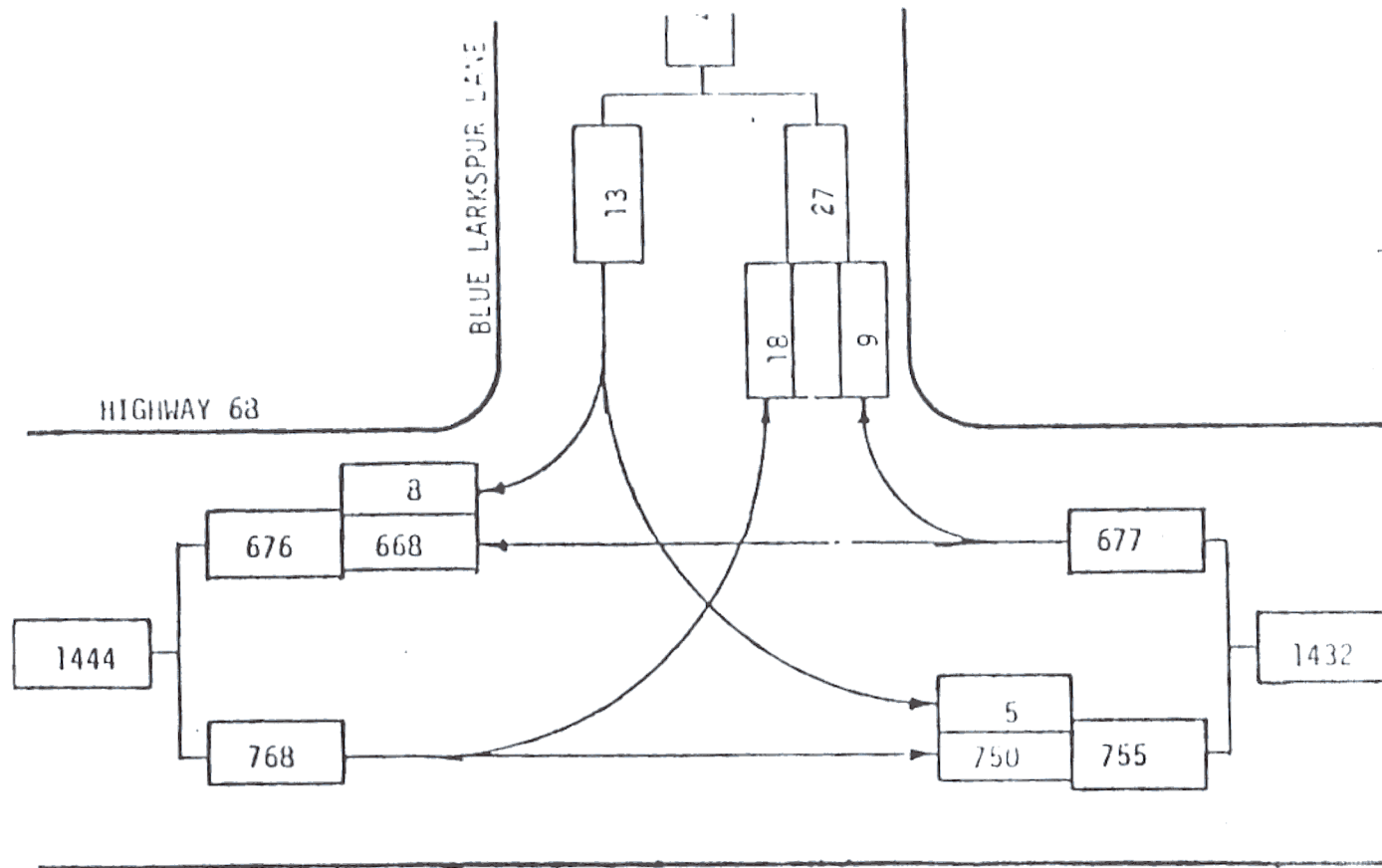

Legend
 Existing traffic counts
 ADT - Average Daily Traffic

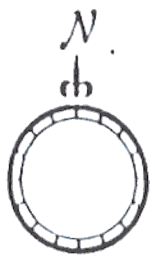

LAGUNA SECA OFFICE PARK
 1980 Peak Hour Volumes

FIGURE 16

Source: William Dryden Consulting Engineers

Table 5

Traffic Characteristics

Street	Speed (MPH)	Lanes of Travel		Average Daily Traffic	
	<u>Signed</u> Expected	1980	2000	<u>1980</u> Project Traffic	<u>2000</u> Project Traffic
Highway 68 (Monterey-Salinas Highway)	<u>55</u> 50-55	2	2-6	<u>12,700-15,000</u> 245-595	<u>49,560-81,780*</u> 6,780-12,600
Highway 218 (Canyon del Rey Boulevard)	<u>55</u> 50-55	2	2-4	<u>4800</u> 150	<u>21,920</u> 2,520

- Note:
- A. Source: California Department of Transportation.
 - B. Peak Hourly Volumes (PHV) are approximately 10 percent of Average Daily Traffic (ADT).
 - C. 1980 Project Traffic includes York School, the golf course and 45 residential units.
- * Includes Montera and Tarpy Flats Developments, which no longer exist because of the defeat of Monterey II.

Access to the on-site street network is presently provided from Highway 68 by Blue Larkspur Lane and York Road. Blue Larkspur Lane provides a two-lane temporary access to Laguna Seca Estates No. 1, with an estimated average daily traffic (ADT) of about 450. Evening peak hour turning volumes at this intersection are illustrated in Figure 16. This is a temporary access that will be closed upon completion of the street network to the Office Park, located between Blue Larkspur Lane and York Road. York Road is a two-lane facility presently providing access to the golf course, York School and Fort Ord Military Reservation.

The north-south portion of York Road at the west end of the Ranch lies within a 70 foot wide strip owned in fee by Fort Ord. The owners of the Laguna Seca Ranch hold a license for use of this road. The owners of the Ranch have reserved a 60 foot roadway easement paralleling York Road so that a new road could be built along this westerly quarter mile should it ever become necessary that the Army revoke the existing license.

The intersection of Highway 68/York Road presently provides a 200 foot left turn lane for the eastbound Highway 68 traffic entering York Road. According to the Monterey County Planning Department, existing average daily traffic (ADT) on York Road is 550.

Public Transit Service

Existing public transit service is provided by the Monterey Peninsula Transit District Route 21. This route operates between Monterey and Salinas at a one hour headway from 6 a.m. to 7 p.m. on weekdays and Saturdays. Sunday service also is provided between 10 a.m. and 7 p.m. Ridership presently has an insignificant impact on vehicular traffic volumes.

Projected Future Traffic Volumes

Traffic from Off-Site Sources. A number of large developments on Highway 68 in the project vicinity are currently in various stages of planning or construction. These include the Garden Road Office Park, the Way Station motel and restaurant, the Trade Center, Monterra Ranch, the Airport Industrial Park, Ryan Ranch and Tarpey Flats, all located to the west of the project; and Hidden Hills. These developments are expected to be completed over the next 25 to 30 years. At that time, total daily external traffic generated from the projects to the west of Laguna Seca are expected to be approximately 84,500, based upon a traffic study for Monterra, Ryan Ranch and Tarpey Flats by TJKM Transportation Consultants. Approximately 25,000 (30%) of these trips are expected to be distributed to the east of their points of generation, and to pass the entrance to Laguna Seca Office Park on Highway 68. Approximately 8724 trip ends (10% of the ADT) are expected during the evening peak hour, with 3571 inbound and 5154 outbound. The resulting peak hour

volumes past Laguna Seca Office Park from these off-site developments are 2620 vehicles per hour, with a directional split of 1070 westbound and 1550 eastbound. Hidden Hills is expected to generate about 600 trips per day with about ten percent in the peak hour. This results in an additional 30 vehicle trips past the Office Park entrance during the peak hour, based upon the directional splits of other off-site projects.

Additional traffic growth on Highway 68 is expected to occur, due to regional growth, at a rate of two percent per annum. The resulting traffic volumes near the Office Park, excluding its future traffic, are shown in Figure 17.

George W. Nickelson, Traffic Engineer, has pointed out in his Traffic Analysis of Laguna Seca Ranch (1981), that the magnitude of added development as projected by the TJKM Transportation Study may be grossly overstated. He indicated that the projected developments would represent a major increase in the employment and population characteristics of the entire County. Over 20,000 new jobs would need to be created along the Highway 68 corridor, as well as 3,400 new residential units (which, in themselves, could not balance the employment demand) in order to arrive at the 8,724 p.m. trip ends.

Furthermore, the projected developments in the TJKM study no longer exist because of the recent rejection of Monterey II. He concludes that the TJKM analysis is tenuous because the actual development along the Highway 68 corridor may be significantly less than projects currently proposed.

Freeway Plan Lines Plan Lines for future freeway construction have been adopted for the entire route between Monterey (Highway 1) and the end of freeway at River Road near Salinas. However, funding currently is unavailable and no specific forecast exists of the timing for conversion. A portion of the future right of way within the plan lines was granted as an easement to Monterey County by the owners of Laguna Seca Ranch at the recordation of the Laguna Seca Ranch Estates No. 2 Subdivision early in 1980.

will utilize as a
and is expected to add 700 vehicle trips per day to York Road,
with 1400 of these during the peak hour. The resulting turning
intersections with Highway 68 are shown on

Figure 18.

The preliminary plans for the freeway include an interchange to serve the Office Park development. This intersection at York Road, also will service Ryan Ranch and the east end of Monterra. The preliminary development plans include cooperation with the developers of Ryan Ranch in any necessary improvements to the present York Road/Highway 68 intersection.

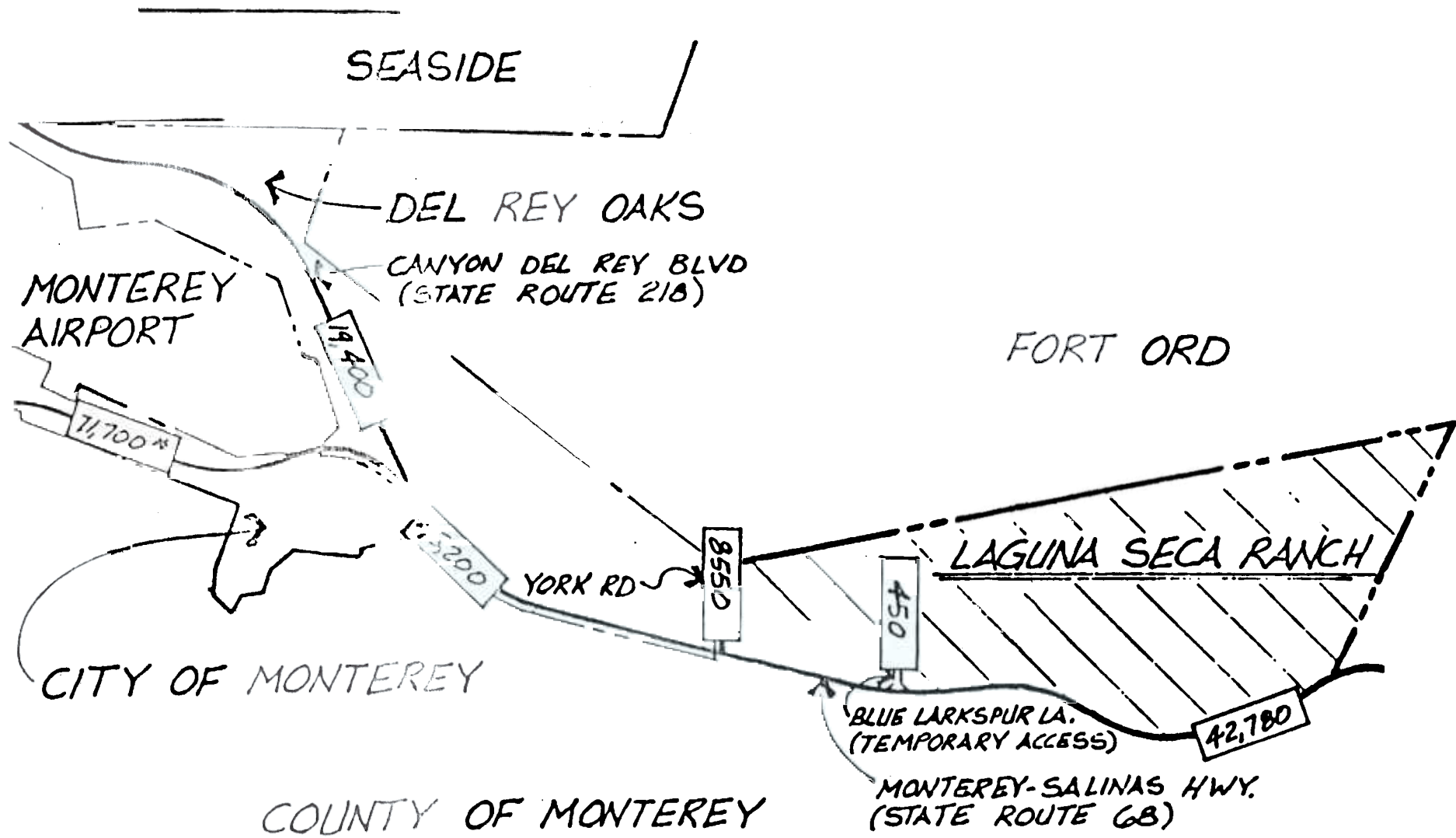

Legend
 ADI - Average Daily Traffic East of Highway 68

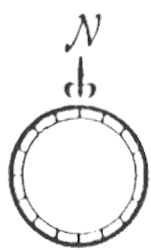

LAGUNA SECA OFFICE PARK
 Traffic Flow Map
 Year 2000 Volumes
 Excluding Project Traffic
 FIGURE 17

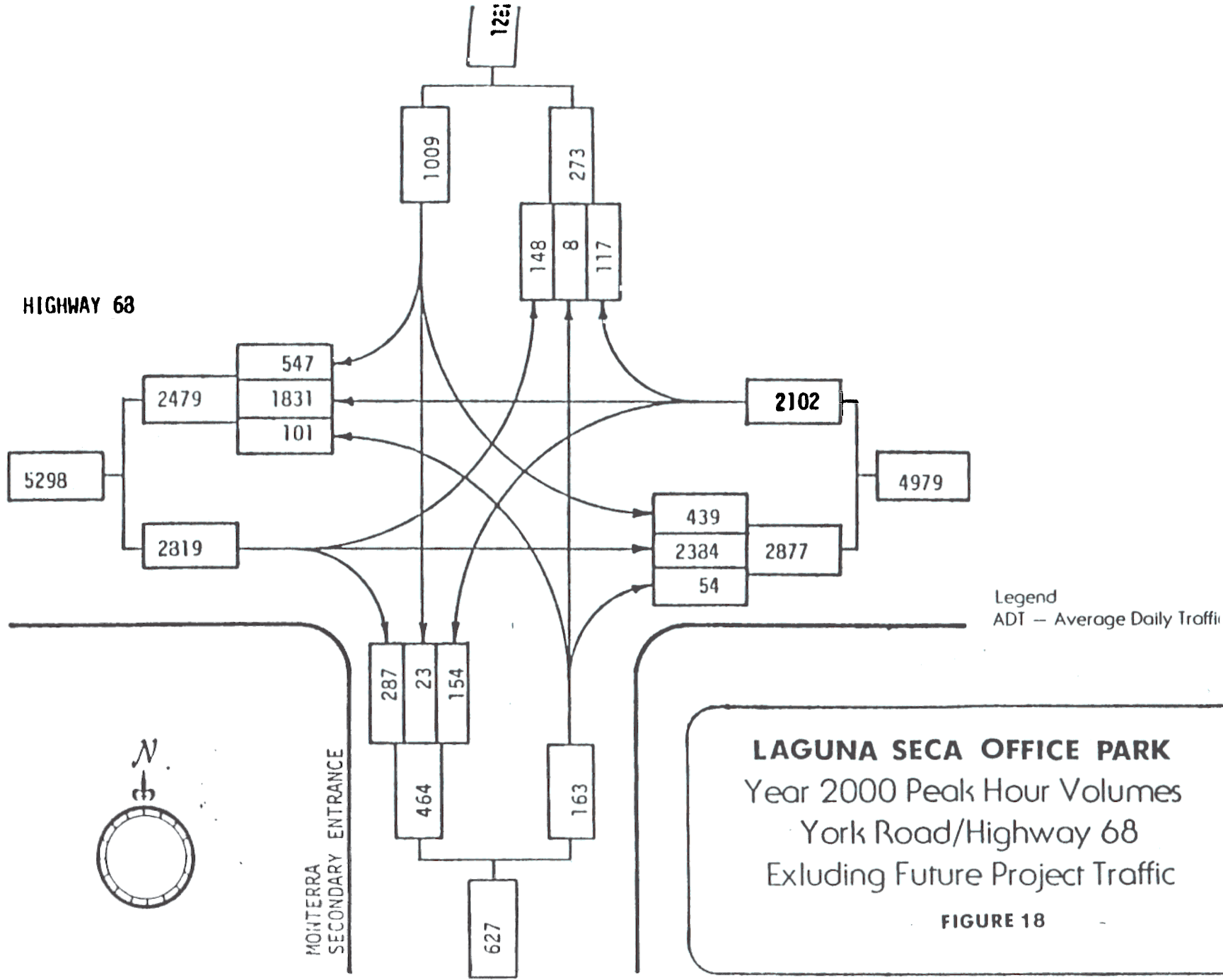

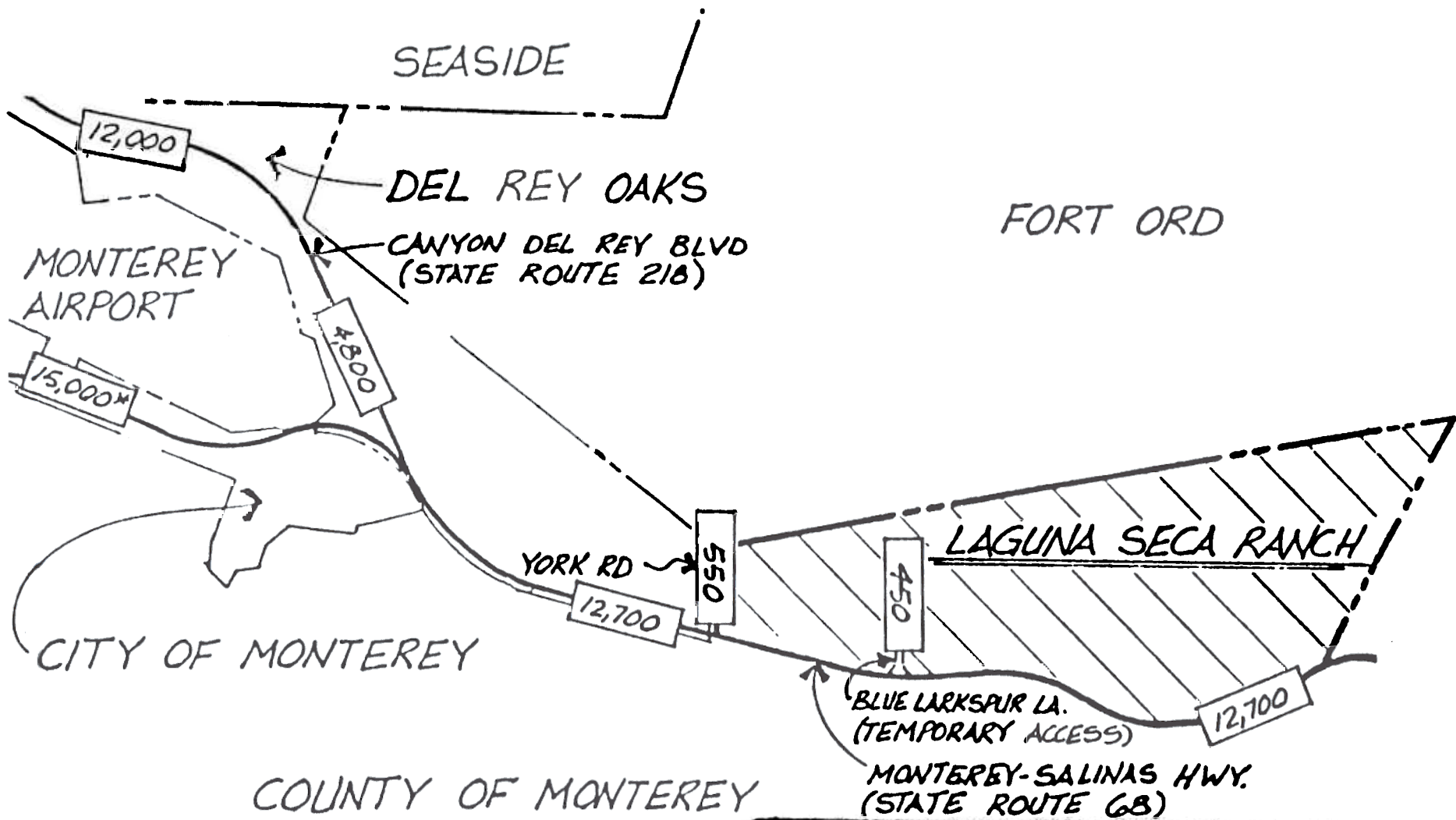

LEGEND
 ADT - Average Daily Traffic
 *Lost of Hwy 1

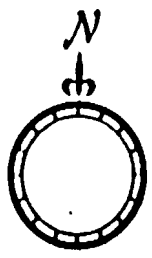

LAGUNA SECA OFFICE PARK
 Traffic Flow Map
 1980 (Existing) Volumes
 Fig. 19

Average Daily Traffic 

HIGHWAY 68

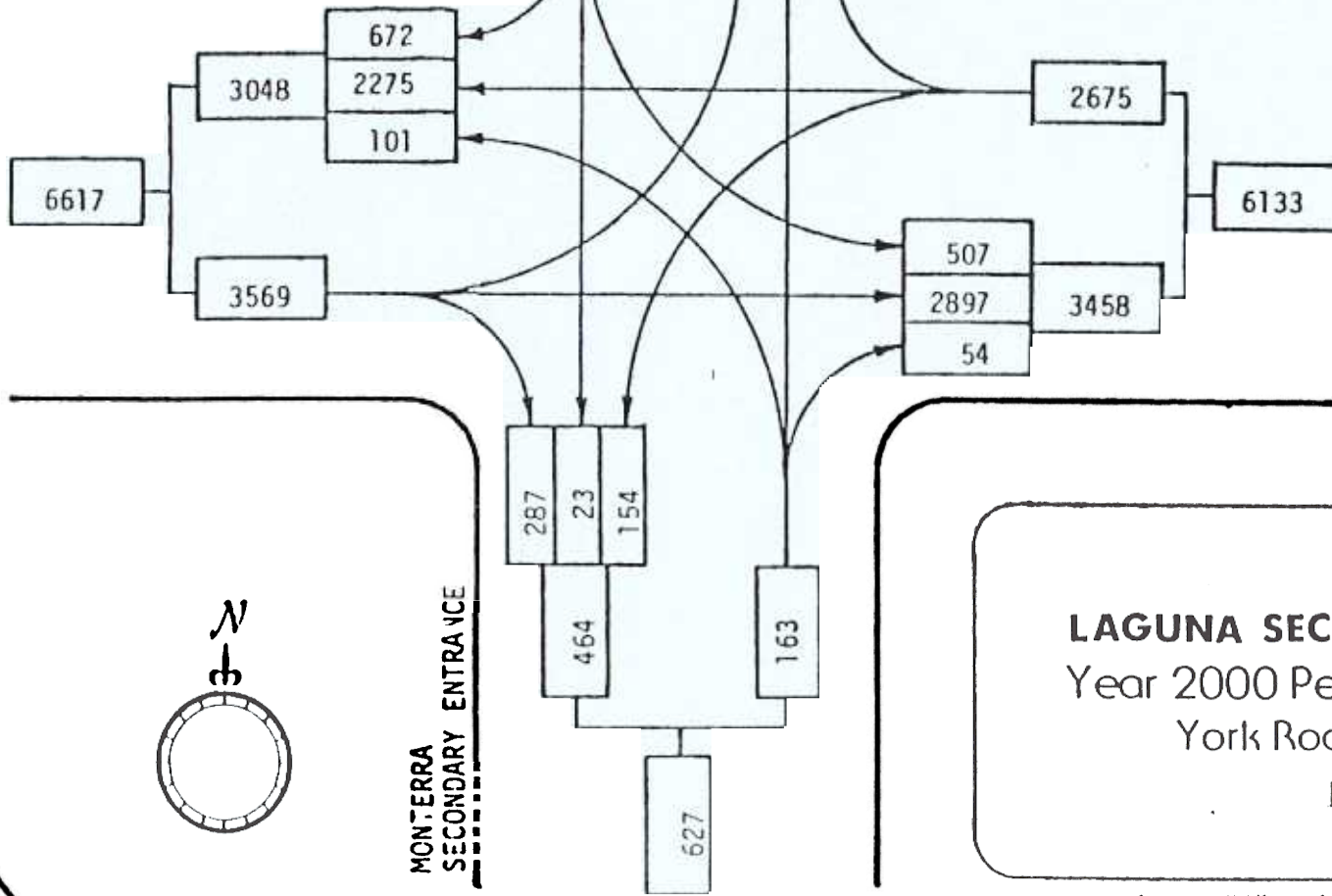

LAGUNA SECA OFFICE PARK
Year 2000 Peak Hour Volumes
York Road/Highway 68

Fig. 20

Source: William Dryden, Consulting Engineers

Project Traffic Generation and Distribution

On-site access to the project site will be provided by York Road which is an existing entrance to the property. Blue Larkspur Lane will be closed to through traffic after development occurs.

According to both Traffic Engineers, Dryden and Nickelson, expected project-generated traffic is 3,120 trips per day and 3,900 average trips per day (ADT).

It has been pointed out by Carl Hooper, Project Engineer for Laguna Seca Office Park, that with a small change in transportation mode, the average trips per day could be reduced by 30% to approximately 2,500 average trips per day. He suggests that 20% of the employees would car pool, 10% would use buses and the remaining 70% use individual cars. Also included in the 2,500 ADT would be 400 customer trips per day. The breakdown would be as follows:

70% in individual cars	= 700 employees X 2.5 trips	= 1,750
20% in car pools	= 200 employees X 2.0 trips	= 400
10% in buses	= 100 employees X 0 trips	= 0
	200 customers X 2.0 trips	= 400
	TOTAL TRIPS	= 2,550

Impacts

Traffic increases external to the project could include 85,120 vehicle trips added over the next 25 to 30 years from various developments near Laguna Seca Office Park plus about a two percent per annum increase due to regional growth.

The professional Office Park development will produce between 2,500 to 3900 average daily trips (ADT).

According to the TKJM Report, near the proposed Office Park Highway 68 presently operates at a D L.O.S., with a v/c ratio of .67. The expected level of service in the year 2000 on a proposed six-lane expressway will be F with a v/c ratio of 1.01 without project traffic.

Traffic signals will be warranted at the project entrance. Additional study of the necessary signal control and intersection geometrics will be required when the type of Highway 68 facility to be constructed is determined.

Additional examination of traffic control will be necessary at York Road/Blue Larkspur Road intersection at the time of development.

Mitigation Measures

Traffic signalization should be provided. Additional study is necessary for the intersection of York Road and Highway 68. Determination of signal phasing, location, timing and intersection geometrics will be required. It has been determined by Public Works that Larkspur Road will be closed.

48. Care should be taken to provide adequate sight distances at all on-site intersections.

Additional study by the County Public Works Department should be made of the usage of Ryan Ranch roads as access routes to Highway 218 from York Road.

Additional bus transit service should be provided to and from Monterey.

The Office Park business organizations should cooperate with one another to provide flexible or staggered business hours and to assist in the formation of carpools or vanpools.

2.8 Air Quality

The northern portion of the Salinas Valley, to which this area is connected, is considered a part of the same air basin as all of the coastal areas of Monterey County. It is identified as the North Central Coast Air Basin. Motor vehicles are the largest source of gaseous pollutants in the North Coastal basins. Carbon monoxide, nitrogen oxides and hydrocarbons comprise the basic category of air pollutants emitted from automobiles. Though the emissions from a particular car do not seem exorbitant, it is the volume which accounts for the pollution potential.

Under the Federal Prevention of Significant Deterioration Program (PSD), areas which are maintaining federal air quality standards currently are being classified. Monterey County presently fails to meet standards designated as Non-Attainment Areas, and is required to prepare a Non-Attainment Plan. A Non-Attainment Plan has been prepared by the Association of Monterey Bay Area Governments (AMBAG); it proposes general measures regarding traffic flow and transit services which should enable this district to meet federal standards by 1982. In addition, general policies pertaining to mobile-source and land-use controls are suggested. Although there are no specific policies for North Monterey County, the plan recommends that all large residential developments be reviewed by AMBAG according to the A95 review process.

Forest Management Plan

LOT 5, LAGUNA SECA OFFICE PARK

Prepared for:

McIntosh Enterprises

Prepared By:

**Roy Webster
Webster & Associates Professional Foresters
3144 North Main Street
Soquel, CA 95073**

September 13, 2011

Lot 5, Laguna Seca Office Park Forest Management Plan

Owner:

McIntosh Enterprises
9400 McIntosh Drive
Monterey, CA 93940

Architect:

Wald, Ruhnke, and Dost
2340 Garden Road
Suite 100
Monterey, CA, 93940

Forester:

Roy Webster RPF #1765
ISA Certified Arborist #WE-6314A
Webster & Associates
3144 North Main Street
Soquel, CA 95073

Purpose:

To satisfy an agreement between the landowners and the County of Monterey that a Forest Management Plan (FMP) be prepared, submitted and approved for the proposed development on this parcel.

Goal:

To offset any potential impacts of proposed development on the property, while encouraging forest stability and perpetuating the forested character of the property.

Management Objectives:

Minimize erosion in order to prevent soil loss and siltation
Preserve natural habitat including native forest, understory vegetation and associated wildlife
Prevent forest fire
Preserve scenic forest canopy as located within the Critical Viewshed (any public viewing area).
Preserve landmark trees to the greatest extent possible as defined below.

Project Description

This project involves the construction of a two-story professional office building consisting of 20,350 gross square feet (16,245 s.f. net leasable). Two parking areas are provided on site consisting of a total of 66 parking stalls.

This Forest Management Plan reviews the proposed development and provides professional forestry recommendations to preserve the forest to the greatest extent feasible.

Site Description

1) Assessors Parcel Number:

173-121-005

2) Location:

The East side of Citation Court approximately 300 feet north of the intersection with Blue Larkspur Lane.

3) Parcel Size:

1.924 acres

4) Existing Land Use:

Undeveloped open space zoned for commercial office.

5) Slopes:

The majority of the parcel is flat to gently sloping (0-10%), heading northerly up to 25% and to the east perimeter 35%.

6) Soils:

Soils onsite are of the Santa Ynez series. These are moderately well drained soils that formed on terraces in alluvium derived from sandstone and granitic rock. In a representative profile the surface layer is grayish brown and gray, medium acid fine sandy loam about 16 inches thick. The subsurface layer is light brownish gray, medium acid fine sandy loam 2 inches thick. The subsoil is gray and grayish brown, medium acid to mildly alkaline clay and clay loam 25 inches thick. The substratum is light gray, moderately alkaline sandy clay loam. Rooting depth can be as deep as 60 inches or more, but some roots are restricted to a depth of 15-30 inches by the clay subsoil. On the Soil Survey of Monterey County prepared by the USDA, Soil Conservation Service, this soil is mapped as "ShE".

7) Vegetation:

The vegetative type of the parcel is Native Oak Woodland. The over story is primarily Coast Live Oak (*Quercus agrifolia*). There are a few Monterey Pines (*Pinus radiata*), which are not natives but likely have reseeded from previous plantings of surrounding woodlands. The native understory ground cover consists of Coyote Bush (*Baccharis pilularis*), Coffeeberry (*Rhamnus californica*), Poison Oak (*Toxicodendron diversilobum*), and various grasses and forbs. There was also invasive, non-native Ice Plant (*Carpobrotus chilensis*).

8) Forest Condition and Health:

This area was regularly burned over by the Native Americans prior to occupation by Europeans. Over the last 3 decades the property has been cleared by hand and tractor. There are pruning cuts evident, most of recent vintage indicative of crown raising.

The Oak trees are generally healthy with full crowns ten to thirty feet tall. Color of the leaves is normal. There was no indication of disease vectors such as Sudden Oak Death (*Phytophthora ramorum*), nor were Bay Laurel trees present (*Umbellularia californica*) which is a common host. Coffeeberry is present which is a host species. No other common diseases of Oaks were noted such as oak root fungus (*Armillaria mellea*), oak bark beetles (*Pseudopityophthorus* spp.) or oak ambrosia beetles (*Monarthrum* spp.).

The Monterey Pines had no evidence of pine pitch canker (*Fusarium circinatum*) or red turpentine beetles (*Dendroctonus valens*).

9) Tree Inventory Data:

Tree inventory data was originally mapped and compiled by Bestor Engineers. I field checked the locations and measurements and they were generally accurate. I did make a few changes. Changes were mostly due to different interpretations of what constituted a single tree with multiple stems or a group of trees. It is not a significant difference. Professional protocol varies, but my standard is that if a tree forks more than one foot above the ground line it is a single tree with multiple stems.

There were a total of 65 Coast Live Oak trees on the parcel. The diameter breakdown is as follows:

Seven trees 2-5 inches in diameter.

Twenty-seven trees 6-10 inches in diameter.

Twenty-four trees 11-20 inches in diameter.

Seven trees 21-32 inches in diameter.

There were 4 Monterey Pines on the parcel. Diameters were as follows: 4", 6", 14", and 15".

TREE REMOVALS

Every consideration was made to preserve as many trees as possible while still creating a feasible development proposal. Considering the distribution of the forest and the landowners desire to build on the parcel, it is not possible to forgo cutting protected trees. The parcel is zoned for commercial office space. Only trees that hinder construction of the driveway, parking lot, office building or infrastructure will be removed.

The needs of the project require the removal of the following trees:

OAKS: (diameter breakdown):

2-5 inches – 3 trees

6-10 inches – 19 trees

11-20 inches – 17 trees

21-32 inches – 4 trees

MONTEREY PINE

None to be removed.

This makes a total of 43 trees requiring removal. Only one landmark tree (greater than 24 inches in diameter) will be removed.

Branches and root wads may be chipped and used as mulch for landscaping, piled and burned in accordance with State and local fire protection authorities, or hauled to a refuse disposal site.

The health of trees remaining should not be affected if the following practices are adhered to:

- A) Do not deposit any fill around trees, which may compact soils and alter water and air relationships. Fill placed within the drip-line may encourage the development of oak rot fungus (*Armillaria mellea*).
- B) Excavation contractor shall be careful not to damage stems and/or exposed roots of trees with heavy equipment. If necessary, trees may be protected by boards, plastic fencing or other materials.
- C) When trees inside the area of development are removed, leave a high stump (24-36 inches) to aid in removal by mechanized equipment. Before excavating the stump and root system, first locate all roots close to the ground surface by visual inspection and probing with a shovel. These roots should be cut before trying to remove the stump. This will make stump removal easier and will insure minimal impact to other trees whose roots may be intertwined with the stump being removed.
- D) Avoid over-watering of remaining trees that may occur if turf or herbaceous plants are grown under the tree canopy. Native oaks are not adapted to summer watering and may develop crown or root rot as a result. Do not irrigate within the dripline of oaks.
- E) The trees remaining near the structures will be bounded by impermeable surfaces. Although these trees should survive, the change in the ground surface underneath the dripline of these trees may affect their long-term health due to a decrease in water availability. These trees should be monitored for any external indicators of stress. If such indicators appear, a professional forester or certified arborist should evaluate the tree for possible removal.

- F) All trees scheduled for preservation shall be temporarily fenced during construction. Plastic fencing should surround trees as far from the trunk as possible when heavy equipment is operated nearby. This will protect as much soil around the base of trees from compaction and increase awareness to operators that fenced trees are to be protected. Fencing shall be installed prior to the issuance of building or grading permits. Generally, fencing shall be placed at the edge of the root zone. The root zone is determined to be that area located within a radius that is 15 times the diameter of the trunk. At no time shall the fencing be located closer than 3' away from the trunk of the tree, or further than 3' away from the proposed building wall line, foundation, retaining wall, or grade cut, whichever provides the greater distance from the tree trunk. Fencing shall be of sturdy construction and be of a color that is highly visible for operator benefit. The minimum height shall be 4'. Fenced-off areas shall not be used for material stockpile, storage or vehicle parking. Dumping of materials, chemicals, or garbage shall be prohibited within the fenced areas. Fenced areas shall be maintained in a natural condition and not impacted. Removal of fencing shall only be approved by the County of Monterey Planning Department. All trees required to be fenced shall be clearly marked with flagging or other identifying mark. The marking is required to notify City inspectors that the subject tree or trees are to be fenced at all times during construction.
- G) Prior to the start of construction, all Monterey Pine trees scheduled for preservation shall have the lower 8' sprayed with lindane, or sevin, in light oil and then wrapped with plastic to reduce the potential for infestation of Red Turpentine Beetles. Unseasoned lumber or freshly cut pine stumps release an attractant, which draws the beetles to the site. The plastic wrap and spray are used to control beetle attacks. Plastic wrap shall remain on the tree throughout the construction period.
- H) Utility and drain lines shall be located outside the root zone (identified in #2) of all trees to be retained. In cases where alternative routes are not available, utility conduit, pipe, wire, and drain lines shall be tunneled under major roots. Major roots are determined to be those that exceed 2" in diameter. In no case shall utility lines be permitted within 6' from the trunk.
- I) All approved construction, trenching, or grading within the root zone of retention trees shall observe the following minimum tree protection standards:
- Hand trenching at point or line of grade cuts closest to the trunk to expose major roots. In cases where rock or unusually dense soils prevent hand trenching, mechanical excavation may be approved on a case specific basis by the planning department, provided that work inside the dripline is closely supervised by the applicant to prevent tearing or other significant damage to major roots.
 - Exposed major roots shall be cut with a saw to form a smooth surface and avoid tearing or jagged edges.
 - Absorbent tarp or heavy cloth fabric shall be placed over new grade cuts where roots are exposed and secure by stakes. 2"-4" of compost or wood chip should then be applied over the tarp for moisture retention. The tarped areas shall be thoroughly watered twice a week until back filling is accomplished. At the time of back filling the tarp shall be removed because research shows that buried tarp material tends to wick moisture from the ground into the atmosphere and may incidentally degrade the roots, which have been protected.
 - Wherever feasible, foundations within a root zone shall be of post and beam construction to eliminate root pruning or removal.
 - Planting beneath retained trees shall take into consideration watering requirement of the tree to prevent damage from over or under watering. Planting beneath oak trees should be avoided. At a minimum, all new irrigation should be directed away from the trunks of oak trees. Do not plant lawns within the root zones of oak trees.

ISSUES COUNTY REQUESTED TO BE ADDRESSED

1. Due to the size and slope of the parcel there is little flexibility in design to retain additional trees. Long term maintenance of residual trees and minimizing removals is addressed in this plan.
2. The following policies have been reviewed in preparation of this plan:
 - a. Monterey County Code - Section 21.64.260
 - b. Greater Monterey Peninsula Area Plan
 - c. Oak Woodlands Conservation Act (PRC Section 21803.4).

The Oak Woodlands Conservation Act addresses protection and land conversion of trees in the genus *Quercus*. This is the primary tree species located on the parcel. It requires protection and mitigation for removal of any Oak tree greater than 5 inches in diameter.

The Greater Monterey Peninsula Area Plan is part of the Monterey County General Plan. It is a long range-planning document that addresses all aspects of future growth, development and conservation. The Plan describes the natural resources of the Monterey Peninsula and identifies constraints for development. Implementation of the plan requires development of ordinances for protection of resources and ongoing review. The ordinances include zoning regulations, subdivision regulations, and individual project review under the California Environmental Quality Act.

Monterey County Code Section 21.64.260 addresses preservation of oaks and other protected trees. The purpose of the Ordinance is to provide regulations for protection and preservation of such trees. The threshold diameter size for this code is 6 inches. We have exceeded these standards by addressing all trees 2 inches and larger

This entire document addresses all of these topics in detail and is designed to conserve and protect the trees long term. Because of the extent of the development, it is impossible to plant one for one all Oaks removed without creating an unhealthy overcrowded stand. Depending on the landscape plan, it may be possible to plant as many as 10 Coast Live Oaks on site. Mitigation for additional removals should be by planting offsite or contributing to the Oak Woodlands Conservation Fund as determined by the regulating bodies.

It is not appropriate at this time to designate replanting areas. There is limited residual space and the landscape plan will dictate what areas are available for planting. In general, any treeless areas where there is a 15-foot diameter circle are appropriate candidates.

The surrounding undeveloped landscape has many acres of undeveloped Oak Woodland. Prevailing sun/wind exposure has little relevance to replanting and maintaining the residual forest. The soils, rainfall, and sun/wind exposure are well adapted to continuation of the Oaks.

Agreement by Landowner:

The following standard conditions are made a part of all Forest Management Plans:

- A. Management Objectives
 1. Minimize erosion in order to prevent soil loss and siltation.
 2. Preserve natural habitat including native forest, understory vegetation and associated wildlife.
 3. Prevent forest fire.
 4. Preserve scenic forest canopy as located within the Critical Viewshed (any public viewing area).
 5. Preserve landmark trees to the greatest extent possible as defined below.

B. Management Measures

1. Tree Removal: No tree will be removed without a Forest Management Plan or an Amended Forest Management Plan.
2. Application Requirements: Trees proposed for removal will be conspicuously marked by flagging or by paint. Proposed removal of native trees greater than six inches will be the minimum necessary for the proposed development. Removal not necessary for the proposed development will be limited to that required for the overall health and long term maintenance of the forest, as verified in this plan or in subsequent amendments to this plan.
3. Landmark Trees: All landmark trees will be protected from damage if not permitted to be removed as a diseased tree, which threatens to spread the disease to nearby healthy trees or as a dangerous tree, which presents an immediate danger to human life or structures.
4. Dead Trees: Because of their great value for wildlife habitat (particularly as nesting sites for insect eating birds) large dead trees will normally be left in place. Smaller dead trees will normally be removed in order to reduce the fire hazard. Dead trees may be removed at the convenience of the owner.
5. Thinning: Trees less than two inches diameter breast height may be thinned to promote the growth of neighboring trees, without first developing a Forest Management Plan.
6. Protection of Trees: All trees other than those approved for removal shall be retained and maintained in good condition. Trimming, where not injurious to the health of the tree, may be performed wherever necessary in the judgment of the owner, particularly to reduce personal safety and fire hazards.
7. Retained trees, which are located close to the construction site, shall be protected from Inadvertent damage by construction equipment through wrapping of trunks with protective materials, bridging or tunneling under major roots where exposed in foundation or utility trenches and other measures appropriate and necessary to protect the well being of the retained trees.
8. Fire prevention: In addition to any measures required by the local California Department of Forestry, the owner will:
 - A) maintain a spark arrester screen atop each chimney
 - B) maintain spark arresters on gasoline powered equipment
 - C) establish a "greenbelt" by keeping vegetation in a green growing condition to a distance of at least 25' feet around the structures
 - D) break up and clear away any dense accumulation of dead or dry underbrush or plant litter, especially near landmark trees and around the greenbelt.
9. Use of fire (for clearing, etc.): Open fires will be set or allowed on the parcel only as a forest management tool under the direction of the Department of Forestry authorities, pursuant to local fire ordinances and directives.
10. Clearing Methods: Brush and other undergrowth, if removed, will be cleared through methods, which will not materially disturb the ground surface. Hand grubbing, tractor crushing and mowing will normally be the methods of choice

11. Irrigation: In order to avoid further depletion of groundwater resource, prevent root diseases and otherwise maintain favorable conditions for the native forest, the parcel will not be irrigated except within developed areas. Caution will be exercised to avoid over watering around trees.
12. Exotic Plants: Care will be taken to eradicate and to avoid introduction of the following pest species:
 - A) Pampas Grass
 - B) Genista (Scotch broom, French broom)
 - C) Eucalyptus (large types)
 - D) Thistles

Amendments

The County of Monterey Director of Planning may approve amendments to this plan, provided that such amendments are consistent with the provisions of the discretionary permit or building submittal. Amendments to this Forest Management Plan will be required for proposed tree removal not shown as part of this Plan, when the proposed removal falls within the description of a Forest Management Plan or Amendment to an existing Forest Management Plan.

Amended Forest Management Plan

- A) An amended forest Management Plan shall be required when:
 1. A forest Management Plan for the parcel has been previously approved by the County of Monterey Director of Planning.
 2. The proposed tree removal as reviewed as part of a development has not been shown in the previously approved Forest Management Plan
- B) At a minimum, the Amended Forest Management Plan shall consist of:
 1. A plot showing the location, type and size of each tree proposed for removal, as well as the location and type of trees to be replanted.
 2. A narrative describing reasons for the proposed removal, alternatives to minimize the amount and impacts of the proposed tree removal, tree replanting information and justification for removal of trees outside of the developed area, if proposed.

Compliance

It is further understood that failure to comply with this Plan will be considered as failure to comply with the conditions of the Use Permit.

Transfer of Responsibility

This plan is intended to create a permanent forest management program for the site. It is understood, therefore, that in the event of a change of ownership, this plan shall be as binding on the new owner as it is on the present owner. As a permanent management program, this Plan will be conveyed to the future owner upon sale of the property.

Lot 5, Laguna Seca Office Park Forest Management Plan

REPORT PREPARED BY:

Roy W. Webster

ROY W. WEBSTER, RPF#1765,
ISA Certified Arborist # WE6314A

9-19-11

DATE

RECOMMENDATIONS AGREED TO BY LANDOWNER

MCINTOSH ENTERPRISES

DATE

FOREST MANAGEMENT PLAN APPROVED BY:

DIRECTOR OF PLANNING DEPARTMENT

DATE

Keith Higgins

Traffic Engineer

September 25, 2019

Dale Ellis
Anthony Lombardo & Associates
144 West Gabilan Street
Salinas, CA 93901

Re: Laguna Seca Apartments Traffic Study Update, Monterey County, California

Dear Dale:

As requested, this provides traffic volume data on Blue Larkspur Lane, York Road and Highway 68 for the proposed 15-unit apartment project on Blue Larkspur Lane in the Laguna Seca Office Park (LSOP) in Monterey County, California. The current letter report, dated November 5, 2018 (included as **Appendix A**), focused on changes in traffic generation if the project site (Lot 5) as well as lots 2-4, 6 and 7 in the Office Park were developed as residential versus office.

The scope of work includes the following tasks.

1. 24-hour roadway segment volumes were collected for 3 days on Blue Larkspur Lane, immediately east of York Road and just west of 9833 Blue Larkspur Lane
2. Volumes on Wilson Road are referenced from recent traffic studies
3. Volumes on York Road are referenced from recent traffic studies
4. The contributions of traffic on York Road from the various sources are estimated
5. Traffic volumes on Highway 68 are referenced from Caltrans and compared with forecasts in the "Final Environmental Impact Report - General Plan Amendment for Laguna Seca Office Park Development," Scott Lefaver, AICP, March 1983 (LSOP EIR), which is included as an attachment to the November 5, 2018 traffic report.
6. Conclusions will be made regarding these comparisons and how they relate to the proposed project.

1. Blue Larkspur Lane Traffic Volumes

Blue Larkspur Lane traffic volumes were counted from Tuesday, September 17, 2019 through Thursday, September 19, 2019 immediately west of York Road and just west of 9833 Blue Larkspur Lane. They are summarized on **Attachment 1**. Raw traffic count data is included in **Appendix B**. Blue Larkspur Lane carries about 676 vehicles per day near 9833 Blue Larkspur Lane. This traffic is solely attributed to Laguna Seca Ranch Estates No. 1. The existing Laguna Seca Office Park currently adds about 1,571 daily trips, 155 AM peak hour trips and 136 PM peak hour trips. This results in a total of 2,247 daily trips, 211 AM peak hour trips and 190 on Blue Larkspur Lane just east of York Road. As indicated on **Attachment 2**, Laguna Seca Ranch Estates1 represents about 30% and Laguna Seca Office Park represents 70% of traffic on Blue Larkspur Lane.

Dale Ellis
September 25, 2019

The LSOP EIR does not provide a traffic forecast for Blue Larkspur Lane. However, as indicated on **Attachment 3**, the LSOP EIR, page 68, estimates that the Laguna Seca Office Park would generate about 525 PM peak hour trips. All of this would be added to the 54 trips from Laguna Seca Ranch Estates 1, for an estimated total of 579 PM peak hour trips. The current PM peak traffic from LSOP plus Laguna Seca Ranch Estates No. 1 is 190. The buildout of Laguna Seca Office Park with office uses would generate about 136 additional PM peak hour trips above current levels, which results in a total of about 326 PM peak hour trips. The buildout of Laguna Seca Office Park with apartments uses would generate about 67 additional PM peak hour trips above current levels, which results in a total of about 257 PM peak hour trips.

Attachment 3 also indicates that the Laguna Seca Office Park was estimated to generate about 3,120 trips per day. All of this would be added to the 676 daily trips from Laguna Seca Ranch Estates 1, for a total of 3,796 daily trips. The buildout of Laguna Seca Office Park with office uses would generate about 1,223 additional trips above current levels, which results in a total of about 3,470 daily trips. The buildout of Laguna Seca Office Park with apartments uses would generate about 878 additional trips above current levels, which results in a total of about 3,125 daily trips.

Conclusion: It is evident that Blue Larkspur Lane will carry lower traffic volumes than originally anticipated in the LSOP EIR whether the Laguna Seca Office Park is built out completely as offices or includes apartments on Lots 2 through 7. In addition, apartments will result in lower traffic volumes on the surrounding streets than office uses, thus having a lesser impact on Blue Larkspur Lane.

2. York Road Traffic Volumes

York Road traffic volumes are referenced from the "Final SR 68 Scenic Highway Plan," Transportation Agency for Monterey County, August 2017. **Attachment 1** provides traffic volumes between Highway 68 and Wilson Road, the eastern entrance to Ryan Ranch, as well as York Road north of Wilson Road. The volumes north of Wilson Road are estimated based on subtracting Blue Larkspur Lane and recent Wilson Road counts from York Road volumes between Highway 68 and Wilson Road. This is only provided as a means of determining the amount of traffic from each development area served by York Road.

York Road currently carries about 7,600 vehicles per day with about 700 in the PM peak hour. **Attachment 2** indicates that about 9% of existing traffic is from Laguna Seca Ranch Estate 1, 21% from Laguna Seca Office Park, 55% from Ryan Ranch Office Park, and 16% from York School, Laguna Seca Golf Ranch and Laguna Seca Ranch Estates 2. Ryan Ranch Office Park represents more than half of the total traffic on York Road north of Highway 68.

As indicated on **Attachment 3**, the LSOP EIR, page 68, estimated that York Road would carry about 9,000 daily trips with 1,810 PM peak hour trips in the Year 2000. That estimate included "Monterey II," which was a very aggressive development plan for the Highway 68 corridor that will not occur. All of the "Monterey II" properties have been developed at far lower intensities or will not be developed at all. Currently, York Road carries about 7,600 daily trips with 700 PM peak hour trips. With the buildout of Laguna Seca Office Park as offices, the totals would increase to about 8,823 daily trips with 836 in the PM peak hour. With the buildout of Lots 2 through 7 as apartments, the totals would increase to about 8,478 daily trips with 767 in the PM peak hour. Either alternative would result in slightly lower daily trips and substantially lower PM peak hour trips than were projected in the LSOP EIR.

Dale Ellis
September 25, 2019

The PM peak hour estimates in the LSOP EIR assumed about 20% of daily traffic would occur in the PM peak hour, which is extremely conservative. About 9.5 % of daily traffic actually occurs in the PM peak hour. Traffic mitigations are generally based on peak hour traffic operations, so the current and anticipated peak hour trips will be less than one-half of the 1983 forecasts. Again, the Laguna Seca Office Park apartment proposal will have less impact than offices.

3. Highway 68 Traffic Volumes

Attachment 1 provides traffic volumes on Highway 68. Highway 68 daily traffic volume of 24,800 is referenced from “Caltrans 2017 Traffic Volumes”, accessed at <https://dot.ca.gov/programs/traffic-operations/census/traffic-volumes/2017>. Traffic Volumes are currently not available for 2018. However, the 2014 volume for this section of Highway 68 is 23,600 (the most recent other volumes on the Caltrans website). Traffic volumes increased about 5% over the 3-year period. This is an annual increase of about 1.7%. Interestingly, the 1998 volume was 23,500. The 20-year trend is about 0.3% growth per year. The 1980 ADT on Highway 68 was 12,700. Traffic volumes have doubled over the last 39 years. This is an annual growth rate of about 2.4%.

The PM peak hour traffic volume on Highway 68 are referenced from the “Final SR 68 Scenic Highway Plan,” Transportation Agency for Monterey County, August 2017. The counts were conducted in February 2016. The volumes are increased 10% to account for seasonality and 3 years of traffic growth.

Attachment 3 indicates that the Year 2000 forecast in the LSOP EIR was 42,780. Again, this was based on the aggressive Monterey II land use forecasts. Current (2019) traffic volumes are only 40% of what was estimated. The LSOP EIR was very conservative and overestimated impacts from long term development. **Attachment 3** also indicates that apartments on Lots 2 - 7 would have less impacts on Highway 68 than offices.

4. Summary and Conclusions

The following is a summary of the report conclusions.

1. Traffic volumes on Blue Larkspur Lane and York Road and Highway 68 are less than LSOP EIR forecasts. They will continue to be lower with buildout of the Laguna Seca Office Park with offices or apartments.
2. The Laguna Seca Office Park currently represents about 70% of traffic on Blue Larkspur Lane and 21% of traffic on York Road.
3. Highway 68 traffic volumes are about 40% less than the volume expected by the Year 2000 in the LSOP EIR.
4. Apartments on Lots 2 through 7 will have lower trip generation and less impacts on Blue Larkspur Lane, York Road and Highway 68 than offices. This does not account for the possibility of apartment residents to work in Laguna Seca Office Park, Ryan Ranch Office Park or other nearby employment centers and use of public transportation or other alternatives.

If you have any questions, please do not hesitate to contact me. Thank you for the opportunity to assist you.

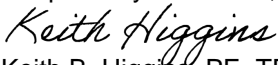
Respectfully submitted,

Keith B. Higgins, PE, TE
Attachments

Attachment 1
Laguna Seca Office Park Vicinity
Existing Daily Traffic Volumes

Street	Count Days	Count Dates	Count Adjustment	Weekday Daily Average	AM Peak Hour		PM Peak Hour		
					Volume	% of Daily	Volume	% of Daily	
Blue Larkspur Lane									
West of 9833 Blue Larkspur Lane	Tuesday - Thursday	9/17-9/19/19	None	676	56	8.3%	54	8.0%	
East of York Road	Tuesday - Thursday	9/17-9/19/19	None	2,247	211	9.4%	190	8.5%	
Wilson Road									
West of York Road	Tuesday - Thursday	7/23-7/25/19	None	4,174	406	9.7%	396	9.5%	
York Road									
North of Wilson Road	Estimate - York Rd N of Hwy 68 minus Blue Larkspur and Wilson			1,179	105	8.9%	114	9.7%	
North of Highway 68	Wednesday	2/23/2016	1.10	7,600	722	9.5%	700	9.7%	

(Allowance for seasonal
adjustment and 3 years growth)

Attachment 2
Contributors to Traffic on Nearby Local Streets

Development	Daily Traffic Generated	Percent Contribution to York at Hwy 68	Percent Contribution to Blue Larkspur
Laguna Seca Ranch Estates 1	676	9%	30%
Laguna Seca Office Park	1,571	21%	70%
Ryan Ranch Office Park	4,174	55%	N.A.
York School, Laguna Seca Golf Ranch and Laguna Seca Ranch Estates 2	1,179	16%	N.A.
Total York Road Between Hwy 68 and Wilson	7,600	100%	N.A.

Attachment 3
Actual versus 1980 EIR Forecast
PM Peak Hour Traffic Volumes

Street	PM Peak Hour Volume				Average Daily Traffic			
	1983 EIR Year 2000 Forecast	Year 2019 Actual	With Lot 2-7 Buildout		1983 EIR Year 2000 Forecast	Year 2019 Actual	With Lot 2-7 Buildout	
			Office	Apartments			Office	Apartments
Project-Generated Traffic			136	67			1,223	878
Blue Larkspur Lane								
West of 9833 Blue Larkspur Lane	N.A.	54	54	54	N.A.	676	676	676
East of York Road	579	190	326	257	3,796	2,247	3,470	3,125
Wilson Road								
West of York Road	N.A.	396	396	396	N.A.	4,174	4,174	4,174
York Road								
North of Wilson Road	N.A.	114	114	114	N.A.	1,179	1,179	1,179
North of Highway 68	1,810	700	836	767	9,000	7,600	8,823	8,478
Highway 68	4,979	2,283	2,364	2,323	42,780	24,800	25,534	25,327

Notes: 1. EIR volumes are referenced from "Final Environmental Impact Report - General Plan Amendment for Laguna Seca Office Park Development," Scott Lefaver, AICP, March 1983

2. Blue Larkspur Lane 2000 Forecast is estimated by adding the project trip generation estimate of 525 PM peak hour trips and 3,120 vehicles per day referenced from the 1980 EIR page 68 to the 676 daily trips generated by Laguna Seca Ranch Estates No. 1.

3. The York Road 1983 EIR Year 2000 Forecast includes the 450 ADT from the Blue Larkspur Lane connection to Hwy 68 added to the 8,550 York Road forecast in Figure 17 of the 1983 EIR.

Appendix A

Laguna Seca Lot 5 Apartments Trip Generation Study

Keith Higgins Traffic Engineer

November 5, 2018

Keith Higgins

Traffic Engineer

November 5, 2018

Alan Hendry, RA
Wald, Ruhnke & Dost Architects, LLP
2340 Garden Road, Suite 100
Monterey, CA 93940

Re: Laguna Seca Lot 5 Apartments Trip Generation Study, Monterey County, CA

Dear Alan,

As you requested, this is a trip generation study for the proposed Laguna Seca Lot-5 Apartments. The project involves the development of a 15-unit apartment on Lot 5, which is a 1.924-acre parcel designated for office development in the Laguna Seca Office Park in Monterey County, California.

The Environmental Impact Report (EIR) for the Laguna Seca Office Park is entitled, the "Final Environmental Impact Report – General Plan Amendment for the Laguna Seca Office Park Development," Scott Lefaver, March 1983 (1983 EIR), which was certified by the County of Monterey. The proposed development included a total of 27.8 acres of professional office park with 19 lots for office development plus two homes. The office park's building floor area was estimated to total 260,000 square feet. This is a floor area ratio of 9,352 square feet per acre. The traffic section of the 1983 EIR is included herein as Appendix A. A total of 13 lots have been developed.

The original Office Park had traffic mitigations and development conditions that were satisfied allowing for development of the Park as individual parcels with office buildings. The proposed apartment requires an amendment to the existing development permits, which includes ascertaining whether the current proposal will represent new traffic impacts. This is the purpose of this study, which determines if the current proposal will generate more trips than predicted in the 1983 EIR.

This study first summarizes the trip generation for the originally proposed office park as documented in the 1983 EIR. This estimate is then compared with a trip generation estimate using the current "Trip Generation Manual," Institute of Transportation Engineers (ITE), 10th Edition, 2017. The trip generation for Lot 5, the site of the proposed apartment, is then estimated for both the proposed apartment and for the site developed as the originally approved professional office.

1. The County of Monterey has requested a trip generation estimate if other currently undeveloped lots also are developed as apartments rather than offices. This would include Lots 2,3,4,6 and 7 in addition to Lot 5. This potential development scenario is discussed in Section 4 of this

letter. **Trip Generation Estimate for Originally Proposed Office Estimated in Original EIR**

On page 68, paragraph 2, in Appendix A, Dryden and Nichol森, 1983 EIR traffic consultants, conservatively estimated that the Laguna Seca Office Park would generate between 3,120 and 3,900 daily trips. The project civil engineer, Carl Hooper, optimistically estimated that the project would have robust carpooling and transit usage that would reduce the net daily trip total to 2,550. Paragraph 6 of page 68 concludes that the project would generate between 2,500 and 3,900 trips per day. This is summarized in Section A of the trip generation spreadsheet on **Table 1**. Incidentally, I prepared the traffic study in 1982 when employed by William G. Dryden.

2. Trip Generation Estimate for Originally Proposed Office Park Using Current ITE Rates

Section B of **Table 1** indicates that the originally proposed professional office land use would be expected to generate 2,700 daily trips, including 19 for the two single family homes included in the project. At Buildout, the office park would be expected to generate about 2,681 daily trips with 303 AM peak hour trips and 284 PM peak hour trips. The daily total using current ITE rates is at the lower end of the range predicted in the 1983 EIR. Current ITE rates corroborate the trip generation estimate used in the EIR, which is actually higher than expected using current ITE rates by as much as 44%.

3. Trip Generation Estimate for Lot 5 as Apartments Compared With Office

Section C of **Table 1** indicates that the proposed 15-unit apartment is expected to generate about 110 daily trips with 7 in the AM peak hour and 8 in the PM peak hour. Lot 5 has a land area of 1.924 acres. Based on a site study by your firm, the site could accommodate a 22,245 square foot office building. Using standard ITE trip rates, this would be expected to generate about 229 daily trips with 26 in both the AM and PM peak hours.

Section C indicates that the apartment building will generate about 120 less daily trips, 19 less AM peak hour trips and 17 less PM peak hour trips than expected from an office building. This is based on trip rates that would result in an estimate of 2,700 daily trips for the Office Park. The currently proposed apartments will generate far less traffic when compared to the conservative rates estimated in the 1983 EIR.

4. Trip Generation Estimate for Remaining Undeveloped Parcels (Lots 2 Through 7) as Apartments Compared With Office

Section D of **Table 1** provides an estimate of trip generation with the development of Lots 2 through 7 as apartments rather than the previously anticipated offices. This includes the proposed project on Lot 5. **Table 2** provides a breakdown of the office floor area that could be developed on each of the 19 lots. Lots 2 through 7 are currently undeveloped. The conversion of Lot 5 from offices to apartments could be the precedent for the conversion of the remaining

Alan Hendry, RA
November 5, 2018

vacant parcels (Lots 2,3,4,6 and 7). The total office building floor area for the six undeveloped parcels is estimated to be 118,570 square feet. To be conservative, it is also assumed that a total of 120 apartments could be developed in place of offices. This is a ratio of 988 square feet of office per apartment. The ratio for Lot 5 is actually 1,483 square feet of office per apartment. In other words, applying the Lot 5 office floor area to apartment ratio to Lots 2 through 7 would result in only 80 apartments. Using standard ITE trip rates, the office buildings on Lots 2 through 7 would be expected to generate about 1,223 daily trips with 138 trips in the AM peak hour and 136 trips in the PM peak hour. The 120 apartments would generate about 878 daily trips with 55 in the AM peak hour and 67 in the PM peak hour. The apartment conversion on Lots 2 through 7 would generate 344 less daily trips, 82 less AM peak hour trips and 69 less PM peak hour trips than expected from an office building. The conversion from offices to apartments on Lots 2 through 7 would result in a reduction in traffic generated by the Laguna Seca Office Park.

5. Conclusion and Recommendation

It is evident that the currently proposed apartments will generate less traffic than an office building with the square footage originally envisioned for Lot 5. The conversion from offices to apartments on Lots 2 through 7 would also result in a reduction in traffic generated by the buildout of the Laguna Seca Office Park. The Office Park fulfilled its conditions of approval based on greater impacts than will actually occur for this parcel even if developed as Offices. On that basis there is no need for further study.

If you have any questions regarding this analysis, please do not hesitate to contact me at your convenience. Thank you for the opportunity to assist you with this project.

Sincerely,

Keith B. Higgins

Keith B. Higgins, PE, TE

enclosures

A. GENERATED TRIPS ESTIMATED IN 1983 EIR	
Laguna Seca Office Park EIR Daily Trip Generation Estimate (Pg 68, 2nd, 3rd and 5th paragraphs)	3,900
High Range	3,120
Mid-Range	2,500
Low Range	

Source: Final Environmental Impact Report – General Plan Amendment for the Laguna Seca Office Park Development,” Scott Lefaver, March 1983, page 68

B. GENERATED TRIPS BASED ON 2017 ITE RATES													
1. 2017 ITE Trip Generation Rates													
ITE LAND USE CODE	DAILY TRIP RATE	AM PEAK HOUR PEAK RATE	AM PEAK HOUR % OF ADT	DAILY TRIP RATE	PM PEAK HOUR PEAK RATE	PM PEAK HOUR % OF ADT	% IN	% OUT	% IN	% OUT	%	%	%
210	9.44	0.74	8%	9.44	0.99	10%	75%	63%	37%				
710	10.31	1.16	11%	10.31	1.15	11%	86%	16%	84%				
220	7.32	0.46	6%	7.32	0.56	8%	23%	63%	37%				
2. Laguna Seca Office Park Trip Generation													
PROJECT SITE	DAILY TRIPS	AM PEAK HOUR PEAK TRIPS	AM PEAK HOUR % OF ADT	DAILY TRIPS	PM PEAK HOUR PEAK TRIPS	PM PEAK HOUR % OF ADT	IN	OUT	IN	OUT	TRIPS	TRIPS	TRIPS
2 homes	19	1	5%	19	2	11%	0	1	1	1	1	1	1
260,000 s.f.	2,681	302	11%	2,681	282	11%	260	42	45	237			
TOTAL:	2,700	303		2,700	284		260	43	46	238			

C. PROPOSED LOT-5 APARTMENT TRIP GENERATION COMPARISON WITH GENERAL OFFICE ALLOWANCE													
Laguna Seca Lot-5 Apartments	15	units	110	7	6%	2	5	8	8%	5	3		
General Office - 1.924 acres	22,245	s.f.	229	26	11%	22	4	26	11%	4	21		
Reduced Trip Generation from Apartments from General Office Allowance	(120)		(19)	(19)		(21)	2	(17)		1	(18)		

D. LOTS 2-7 APARTMENT TRIP GENERATION COMPARISON WITH GENERAL OFFICE ALLOWANCE													
Laguna Seca Lot2 2 through 7 Apartments	120	units	878	55	6%	13	43	67	8%	42	25		
General Office - 1.924 acres	118,570	s.f.	1,223	138	11%	118	19	136	11%	22	115		
Reduced Trip Generation from Apartments from General Office Allowance	(344)		(82)	(82)		(106)	23	(69)		21	(90)		

Notes:

1. Trip generation rates from Institute of Transportation Engineers (ITE), *Trip Generation Manual*, 10th Edition, 2017, unless otherwise noted.
2. The Laguna Seca Office Park EIR General Office building area estimate of 260,000 square feet assumes a floor area ratio of 21.4%, or 9,352 gross square feet of building floor area per acre for the 27.8 acres of R-3 (Office) lots.

Keith Higgins
Traffic Engineer

LAGUNA SECA OFFICE PARK

Land Use Summary

LOT NUMBER	APN	PROPOSED RESIDENTIAL	ACTUAL SIZE BUILT OFFICE
1	173-121-001		8,810
2	173-121-002	22,014	
3	173-121-003	17,560	
4	173-121-004	22,620	
5	173-121-005	22,245	
6	173-121-006	18,236	
7	173-121-007	15,895	
8	173-121-008		7,444
9	173-121-009		12,200
10	173-121-010		14,472
11	173-121-011		12,113
12	173-121-012		12,010
13	173-121-013		18,905
14	173-121-014		10,617
15	173-121-015		11,317
16	173-121-016		18,425
17	173-121-017		5,471
18	173-121-018		7,498
19	173-121-019		13,696
TOTALS- Office Floor Area (S.F.)		118,570	152,978

Keith Higgins
Traffic Engineer

Table 2
Laguna Seca Office Park
Land Use Summary

Appendix A
1983 EIR Excerpts

FINAL
ENVIRONMENTAL IMPACT REPORT
GENERAL PLAN AMENDMENT
FOR THE
LAGUNA SECA OFFICE PARK
DEVELOPMENT
BASE MAP #17

MARCH 1983

Prepared for:

County of Monterey Planning Department

KIR # 80-109

PC-3734 (REZONING)

PC-3834 (GENERAL PLAN AMMENDMENT)

SUBD 755

Prepared by:

Scott Lefaver, A.I.C.P

565 Chapman Court

Santa Clara, California 95050

CERTIFIED AS FINAL EIR BY
MONTEREY COUNTY BOARD OF
SUPERVISORS ON FEB 22 1983

FINAL
ENVIRONMENTAL IMPACT REPORT
GENERAL PLAN AMENDMENT
FOR THE
LAGUNA SECA OFFICE PARK
DEVELOPMENT
BASE MAP #17

MARCH 1983

LOAN COPY
PLEASE RETURN

Prepared for:

County of Monterey Planning Department

EIR # 80-109

PC-3734 (REZONING)

PC-3834 (GENERAL PLAN AMMENDMENT)

SUBD 755

Prepared by:

Scott Lefaver, A.I.C.P.

565 Chapman Court

Santa Clara, California 95050

TABLE OF CONTENTS

SUMMARY	1
List of Figures	iii
List of Tables	iv
1.0 INTRODUCTION	6
1.1 Forward	6
1.2 Project Description	6
Site Location and Description	6
Background	8
Existing Improvements	8
Proposed Project Development	8
Residential	10
Commercial	10
Neighboring and Vicinity Land Use	10
1.3 Land Use and Planning	11
Planning Process, County of Monterey	11
County of Monterey, Applicable Plans and Policies	14
Monterey County General Plan	14
Historical Element	15
Circulation Element	15
Scenic Highway Element	15
Noise Element	16
Conservation/Open Space Element	16
Safety Element	17
Seismic Safety Element	17
General Development Plans for Laguna Seca Ranch	18
Other Applicable Plans and Policies	18
Monterey Peninsula Airport Master Plan	19
Monterey County Transportation Plan	19
Association of Monterey Bay Area Governments	19
Zoning	20
1.4 Project Economics	20
Economic Impact Upon the Monterey Area	20
2.0 ENVIRONMENTAL SETTING	21
2.1 Regional Setting	21

2.2	Regional Geology	21
	Regional Faulting	23
	Local Faulting	23
	Site Geology	26
	Seismic Hazards and Earthquake Potential	29
	Slope Stability	30
2.3	Soils.	33
2.4	Hydrology	36
	Surface Hydrology	36
	Groundwater	41
2.5	Biological Resources	49
	Vegetation	49
	Wildlife	51
2.6	Viewshed	54
2.7	Traffic	59
2.8	Air Quality	69
2.9	Noise and Airport Safety	72
2.10	Public Utilities	81
	Sanitary Sewer	81
	Water Service	85
	Fire Protection	87
	Police Protection	89
	Public Utilities	90
	Energy Conservation	90
2.11	Archaeology	91
3.0	ENVIRONMENTAL EVALUATION	92
	Cumulative Impacts	92
	Adverse Effects Which Cannot be Avoided if the Project is Implemented	100
	Alternatives	101
	No Project	101
	All Residential	102
	Higher Density	102

The Relationship between Local Short Term Uses of Man's Environment and the Maintenance and Enhancement of Long Term Productivity	101
3.5 Irreversible Environmental Changes Which Will be Involved in the Proposed Action Should it be Implemented	103
3.6 Growth Inducing Impacts	104
4.0 BIBLIOGRAPHY, PERSONS CONSULTED AND STAFF	105
4.1 Bibliography	105
Persons Consulted	106
Staff	107
5.0 APPENDICES	
Appendix A Initial Studies: County of Monterey	
Appendix B Geology	
Appendix C Groundwater Survey	
Appendix D Vegetative and Wildlife Species List	
Appendix E Noise Survey Location Map	
Appendix F Wastewater Reclamation System	
Appendix G Fiscal Impact Report	
Appendix H Comments in Response to Draft EIR	
Appendix I Response to Comments	
Appendix J Additional Comments by Public Works Department, County of Monterey	
Appendix K Comments on the County of Monterey's Newly Adopted General Plan	

LIST OF FIGURES

Figure 1	Regional Setting	7
Figure 2	Office Park Development Tentative Map	9
Figure 3	Project Site Vicinity	11
Figure 4	Existing Zoning	13
Figure 5	Local Vicinity Topography	22
Figure 6	Local Faulting	24
Figure 7	Regional Faulting	25
Figure 8	Site Geology	27
Figure 9	Geologic Cross Sections	28
Figure 10	Earthquake Intensity Zones	31
Figure 11	Soils	34
Figure 12	Drainage	38
Figure 13	Water Table Map	44
Figure 14	Vegetative Communities	52
Figure 15	Viewshed	55
Figure 16	1980 Peak Hour Traffic Volumes	60
Figure 17	Traffic Flow Map - Year 2000 Volumes Excluding Project Traffic	64
Figure 18	Year 2000 Peak Hour Volumes YorkRoad/Highway 68 Excluding Future Project Traffic	65

Figure 19	Traffic Flow Map 1980 Existing Volumes	66
Figure 20	Year 2000 Peak Hour Volumes - York Road/ Highway 68	67
Figure 21	Existing Noise Contours	73
Figure 22	Future Noise Conditions, ANCLUC Study	76
Figure 23	Proposed Sewage Facility	84
Figure 24	Regional Area Developments	95

LIST OF TABLES

Table 1	Uses Proposed for Office Park Development	10
Table 2	Geotechnical Hazards Identified at the Laguna Seca Ranch Subdivision Site	17
Table 3	Regional Faulting	23
Table 4	Groundwater in Storage in Laguna Seca Ranch	43
Table 5	Traffic Characteristics	61
Table 6	Mobile Source Emissions Generated by the Project	71
Table 7	Laguna Seca Ranch Noise dbA Readings	74
Table 8	Land Use Compatibility for Community Noise Environments: Outdoor Noise Levels	75
Table 9	Cumulative Impact Review: Hidden Hills Development	94
Table 10	Projected Water Use: Laguna Seca Watershed, Year 2000	99

1.2.2 Background

The proposed Office Park is owned by the Bishop, McIntosh and McIntosh partnership. A golf course adjacent to the Park is also owned by the partnership, but is under lease to Nick Lombardo. The school, 20 acres in the northwest corner, is owned by York School. Laguna Seca Ranch Estates No. 1, 46 lots on 39 acres near the southwest corner, is owned by 46 individuals or families, with appurtenant open space owned by a Home Owners Association. Laguna Seca Ranch Estates No. 2 (49 lots on 135 acres) was developed in 1980. Some lots in Unit 2 have been sold and several homes are under construction, however none have been occupied or completed as of August 1, 1982. The Laguna Seca Ranch was acquired by Frank Bishop in 1953; the subdivision was created in 1962, the York School in 1964, and the golf course in 1969. York Road, a 1500 foot long, 70 foot wide strip, is owned by the U.S. Government and is a part of Fort Ord.

1.2.3 Proposed Project Development

The proposed development consists of 260,000 square feet of office space located on 54 acres at the south westerly section of the Laguna Seca Ranch. The professional offices will include financial institutions and business offices to be developed on 19 lots ranging from .6 to 2.6 acres. The lots will be sold or leased for the construction of custom designed buildings. The Tentative Subdivision Map for this office park development is included as Figure 2.

The development also proposes two single family lots (20 and 21) to be located adjacent to the existing Ranch Estates No. 1. The probable gross office space (260,000 square feet) was calculated at an average of 20% ground coverage, with 10% designated as two story. Table 1 details the uses at the site.

Lots 1 through 19 are proposed for office and professional uses and two lots (20 and 21) for single family uses adjacent to the existing Laguna Seca Ranch Estates No. 1. The average size of the office park lots is 1.46 acres, the smallest of these lots being .66 acres. Lot 20 is proposed for .82 acres and Lot 21 for 1.08 acres for single family homes.

The site is accessed along the existing York Road to the proposed Blue Larkspur Lane. The area south of this roadway will remain as open space until such time as area for expansion of Highway 68 is needed. The highway entrance to Laguna Seca Ranch Estates will be closed upon construction of Blue Larkspur Lane from York Road. (Refer to Figure 2.)

LAGUNA SECA OFFICE PARK
Office-Park Development
Tentative Map

FIGURE 2

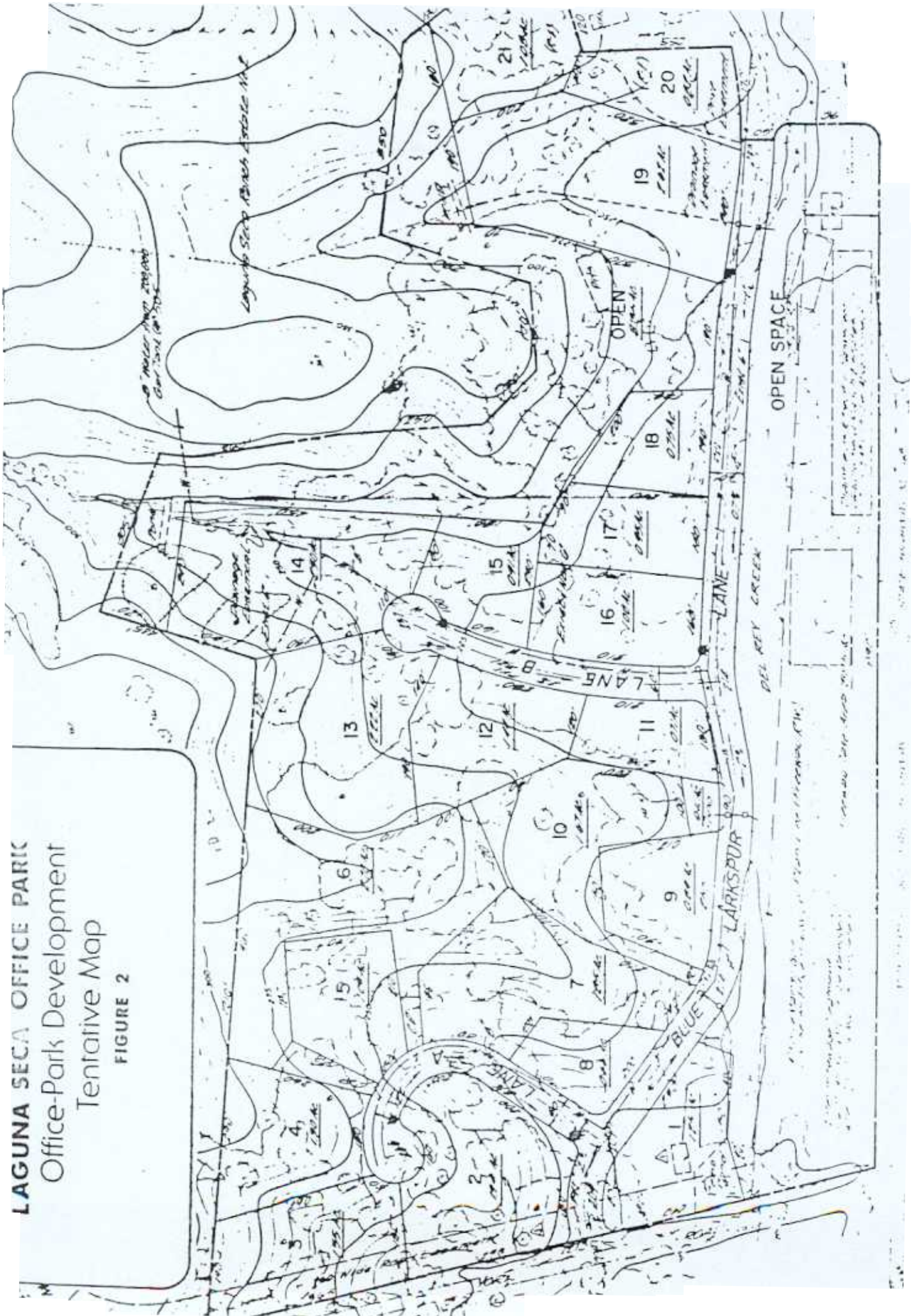

Table 1
Use Proposed for Office Park Development

Use	Net Acres	Percent
Roads	4.45	8.2
Common Drives	0.25	0.5
Freeway Take	8.85	16.1
Open Space	11.66	21.2
R-3 Lots (Office)	27.80	50.6
R-1 Lots (Single Family Homes)	1.40	3.5
TOTAL	54.91	100.0

1.2.4 Neighboring and Vicinity Land Use

The land in the vicinity of the project site, with its pastoral, semi-rural setting and attendant qualities (grassy meadows, oak groves, steep chaparral-covered slopes and pine forest), is a contrast to the urban city of Monterey. The area always has been a source of visual enjoyment for those passing by it on Highway 68, which was declared a Scenic Highway by the State of California in 1969.

The properties surrounding Laguna Seca Office Park are varied in their type and intensity of use. Generally, much of the land currently is undeveloped and/or in limited residential and agricultural use. However, there has been much planning activity on the part of landowners of the area, and there is evidence that substantial development could occur in the future.

The project site is within the former Monterey II Planning Area, located along the Highway 68 corridor. In March of 1976, the City of Monterey adopted its Monterey II Plan for this area. Based upon this plan a number of development proposals were prepared for almost 85% of the 8,300 acre Monterey II area over the last two decades. These proposals covered all of the 5 major land holdings in this area (Work Ranch, Lit Ng, Hidden Hills, Laguna Seca Ranch and Pebble Beach Corporation Properties). However, in November 1981 the people of the City of Monterey repealed the Monterey II Plan. Therefore, the future development of the surrounding area is unknown. Development can occur within the County as designated by the County's General Plan. No high intensity urban development can take

Street furniture, such as lamp posts, benches, litter containers, hydrants, plant containers, et cetera, shall be of a design compatible with the architecture and the character of the land and shall be consistent throughout the development.

All signs shall conform to an overall sign design concept coordinated through the entire development. This overall sign design concept will control color, shape, size and content of all signs. Symbols rather than words shall be used wherever possible.

Shingle roofs and/or tile stucco and natural wood siding exterior walls, arranged with particular attention to human size, shall dominate the architectural design of all buildings. Building complexes shall be designed to follow the existing slope of the land and be planned to minimize exposed earth cuts and fills and to preserve existing trees. In all cases, the forest shall take aesthetic precedence over structures and shall penetrate building complexes. Colors shall be selected from a recommended color palette. Color accents, in general, will be in doorways, windows, and on selected wall areas.

Exposed mechanical devices, such as radio and TV antennas, blowers, air conditioning devices, et cetera, will be minimized and blended. All utilities are to be underground.

Traffic and Circulation

Traffic Volumes

The following discussion is taken from traffic reports prepared for the area by William Dryden, Consulting Engineers and George W. Nickelson, P. E., Traffic Engineer.

Access to the project vicinity is provided by State Highway 68 (Monterey-Salinas Highway), which is a two-lane rural highway which runs in an east/west direction. It is the main traffic corridor between Salinas and Monterey. Current daily traffic volumes near the project site on Highway 68 average about 12,700 with peak hour volumes of approximately 1,250, based upon recent CalTrans counts summarized in Table 5 and illustrated in Figure 16. The peak hour level of service (L.O.S.) is D, with a volume to capacity (v/c) ratio of .67.

Additional access to the project vicinity is provided by State Highway 218 (Canyon del Rey Boulevard), which is a two-lane rural highway, in the vicinity of its intersection with Highway 68 -- approximately a half mile west of the Office Park. It provides service to State Highway 1 in Seaside via Del Rey Oaks. Average daily traffic (ADT) on Highway 218 is presently about 4800 near the junction of Highway 68.

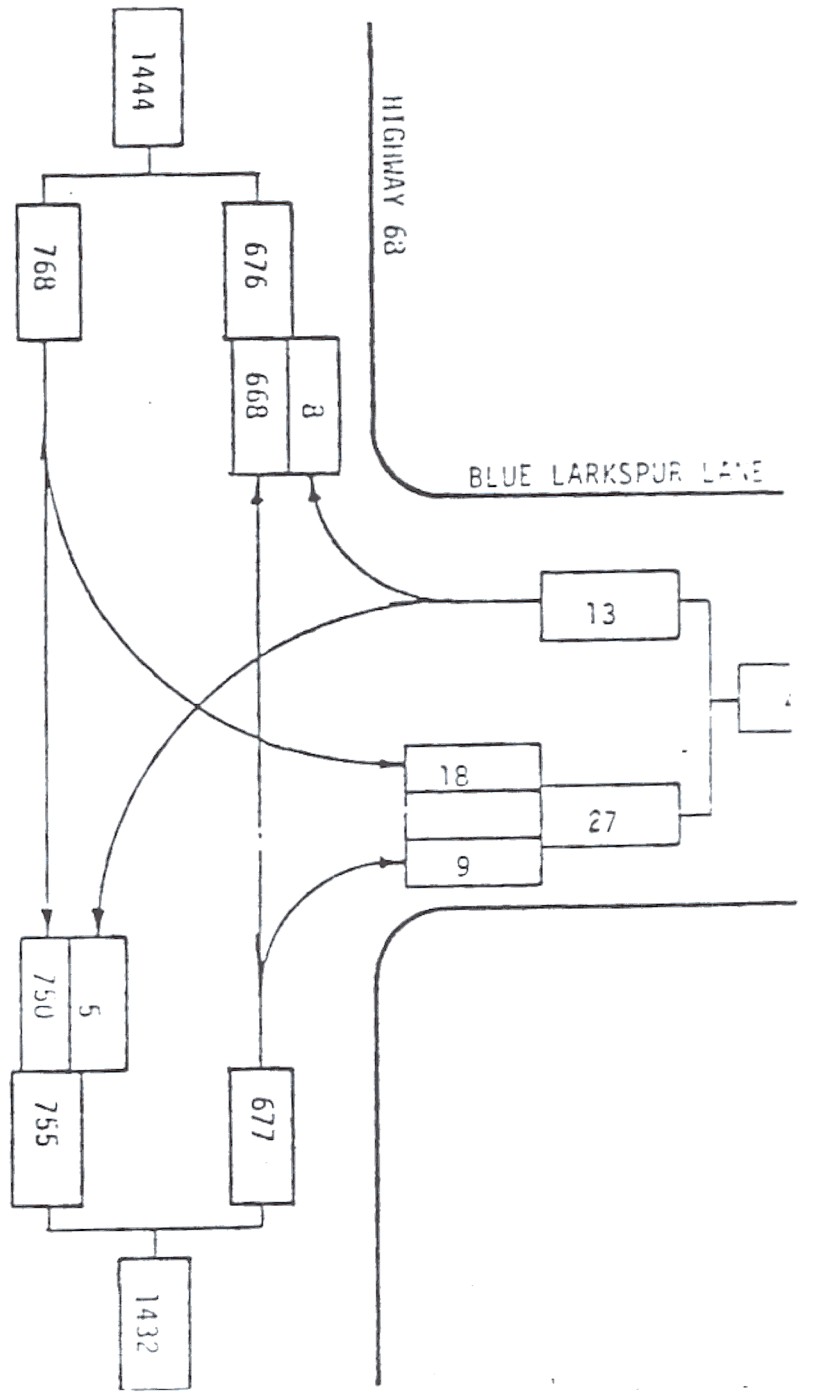

Legend
 Existing traffic counts
 ADI - Average Daily Traffic

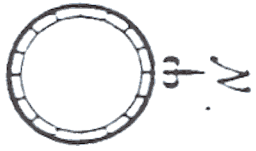

LAGUNA SECA OFFICE PARK
 1980 Peak Hour Volumes
 FIGURE 16

Source: William Engelen Consulting Engineers

Table 5

Traffic Characteristics

Street	Speed (MPH)		Lanes of Travel		Average Daily Traffic	
	Signed	Expected	1980	2000	1980	2000
Highway 68 (Monterey-Salinas Highway)	55		2	2-6	$\frac{12,700-15,000}{245-595}$	$\frac{49,560-81-780^*}{6,780-12,600}$
Highway 218 (Canyon del Rey Boulevard)	55		2	2-4	$\frac{4800}{150}$	$\frac{21,920}{2,520}$

Note: A. Source: California Department of Transportation.
 B. Peak Hourly Volumes (PHV) are approximately 10 percent of Average Daily Traffic (ADT).
 C. 1980 Project Traffic includes York School, the golf course and 45 residential units.

* Includes Monterera and Tarpv Flats Developments, which no longer exist because of the defeat of Monterey II.

Access to the on-site street network is presently provided from Highway 68 by Blue Larkspur Lane and York Road. Blue Larkspur Lane provides a two-lane temporary access to Laguna Seca Estates No. 1, with an estimated average daily traffic (ADT) of about 450. Evening peak hour turning volumes at this intersection are illustrated in Figure 16. This is a temporary access that will be closed upon completion of the street network to the Office Park, located between Blue Larkspur Lane and York Road. York Road is a two-lane facility presently providing access to the golf course, York School and Fort Ord Military Reservation.

The north-south portion of York Road at the west end of the Ranch lies within a 70 foot wide strip owned in fee by Fort Ord. The owners of the Laguna Seca Ranch hold a license for use of this road. The owners of the Ranch have reserved a 60 foot roadway easement paralleling York Road so that a new road could be built along this westerly quarter mile should it ever become necessary that the Army revoke the existing license.

The intersection of Highway 68/York Road presently provides a 200 foot left turn lane for the eastbound Highway 68 traffic entering York Road. According to the Monterey County Planning Department, existing average daily traffic (ADT) on York Road is 550.

Public Transit Service

Existing public transit service is provided by the Monterey Peninsula Transit District Route 21. This route operates between Monterey and Salinas at a one hour headway from 6 a.m. to 7 p.m. on weekdays and Saturdays. Sunday service also is provided between 10 a.m. and 7 p.m. Ridership presently has an insignificant impact on vehicular traffic volumes.

Projected Future Traffic Volumes

Traffic from Off-Site Sources. A number of large developments on Highway 68 in the project vicinity are currently in various stages of planning or construction. These include the Garden Road Office Park, the Way Station motel and restaurant, the Trade Center, Monterra Ranch, the Airport Industrial Park, Ryan Ranch and Tarpey Flats, all located to the west of the project; and Hidden Hills. These developments are expected to be completed over the next 25 to 30 years. At that time, total daily external traffic generated from the projects to the west of Laguna Seca are expected to be approximately 84,500, based upon a traffic study for Monterra, Ryan Ranch and Tarpey Flats by TJKM Transportation Consultants. Approximately 25,000 (30%) of these trips are expected to be distributed to the east of their points of generation, and to pass the entrance to Laguna Seca Office Park on Highway 68. Approximately 8724 trip ends (10% of the ADT) are expected during the evening peak hour, with 3571 inbound and 5154 outbound. The resulting peak hour

volumes past Laguna Seca Office Park from these off-site developments are 2620 vehicles per hour, with a directional split of 1070 westbound and 1550 eastbound. Hidden Hills is expected to generate about 600 trips per day with about ten percent in the peak hour. This results in an additional 30 vehicle trips past the Office Park entrance during the peak hour, based upon the directional splits of other off-site projects.

Additional traffic growth on Highway 68 is expected to occur, due to regional growth, at a rate of two percent per annum. The resulting traffic volumes near the Office Park, excluding its future traffic, are shown in Figure 17.

George W. Nickelson, Traffic Engineer, has pointed out in his Traffic Analysis of Laguna Seca Ranch (1981), that the magnitude of added development as projected by the TJKM Transportation Study may be grossly overstated. He indicated that the projected developments would represent a major increase in the employment and population characteristics of the entire County. Over 20,000 new jobs would need to be created along the Highway 68 corridor, as well as 3,400 new residential units (which, in themselves, could not balance the employment demand) in order to arrive at the 8,724 p.m. trip ends.

Furthermore, the projected developments in the TJKM study no longer exist because of the recent rejection of Monterey II. He concludes that the TJKM analysis is tenuous because the actual development along the Highway 68 corridor may be significantly less than projects currently proposed.

Freeway Plan Lines Plan Lines for future freeway construction have been adopted for the entire route between Monterey (Highway 1) and the end of freeway at River Road near Salinas. However, funding currently is unavailable and no specific forecast exists of the timing for conversion. A portion of the future right of way within the plan lines was granted as an easement to Monterey County by the owners of Laguna Seca Ranch at the recordation of the Laguna Seca Ranch Estates No. 2 Subdivision early in 1980.

will utilize as a
and is expected to add 700 vehicle trips per day to York Road,
with 1400 of these during the peak hour. The resulting turning
intersections with Highway 68 are shown on

Figure 18.

The preliminary plans for the freeway include an interchange to serve the Office Park development. This intersection at York Road, also will service Ryan Ranch and the east end of Monterra. The preliminary development plans include cooperation with the developers of Ryan Ranch in any necessary improvements to the present York Road/Highway 68 intersection.

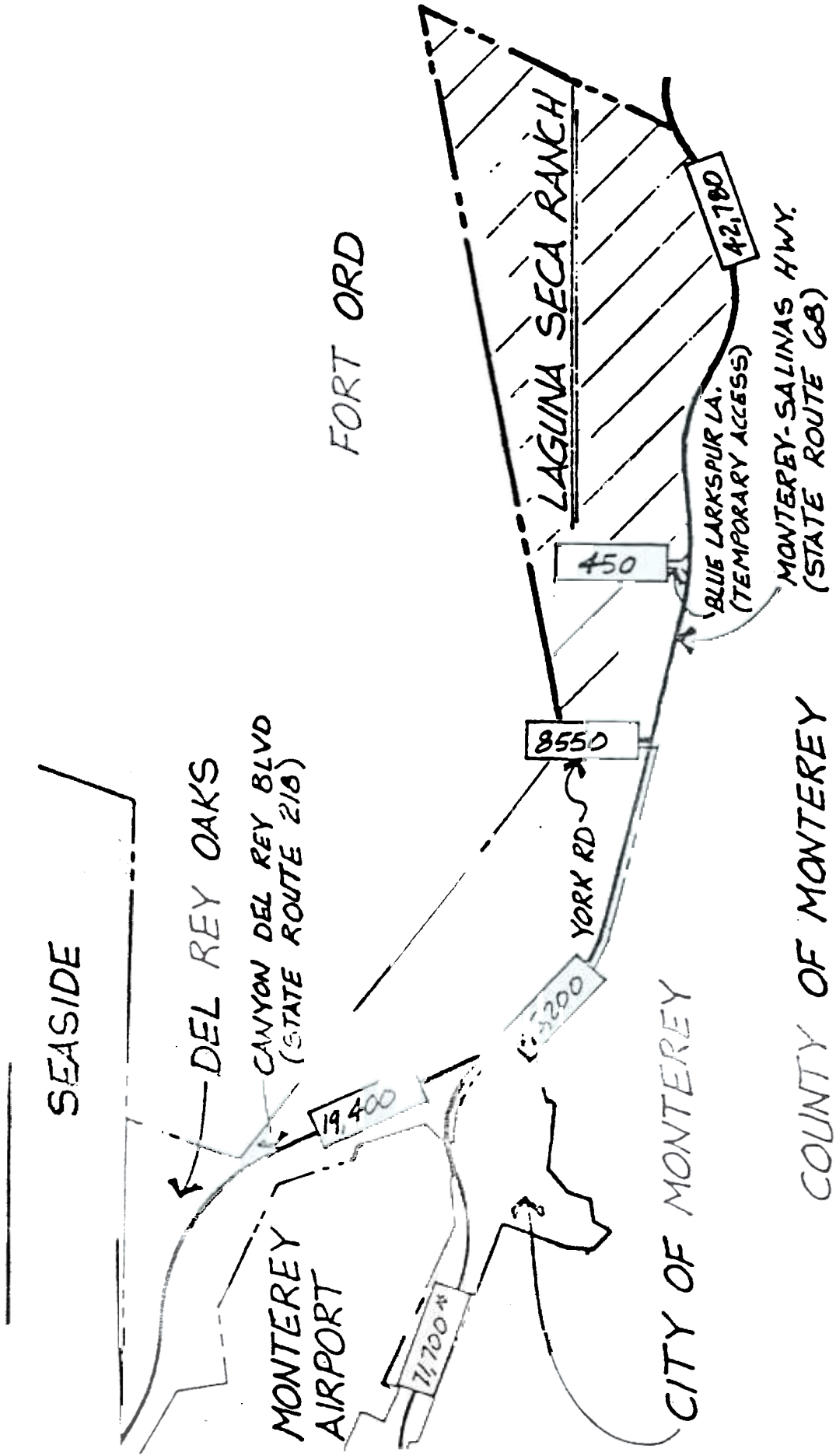

Legend
 ADI - Average Daily Traffic East of Highway 68

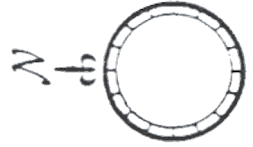

LAGUNA SECA OFFICE PARK
 Traffic Flow Map
 Year 2000 Volumes
 Excluding Project Traffic

FIGURE 17

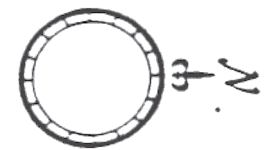
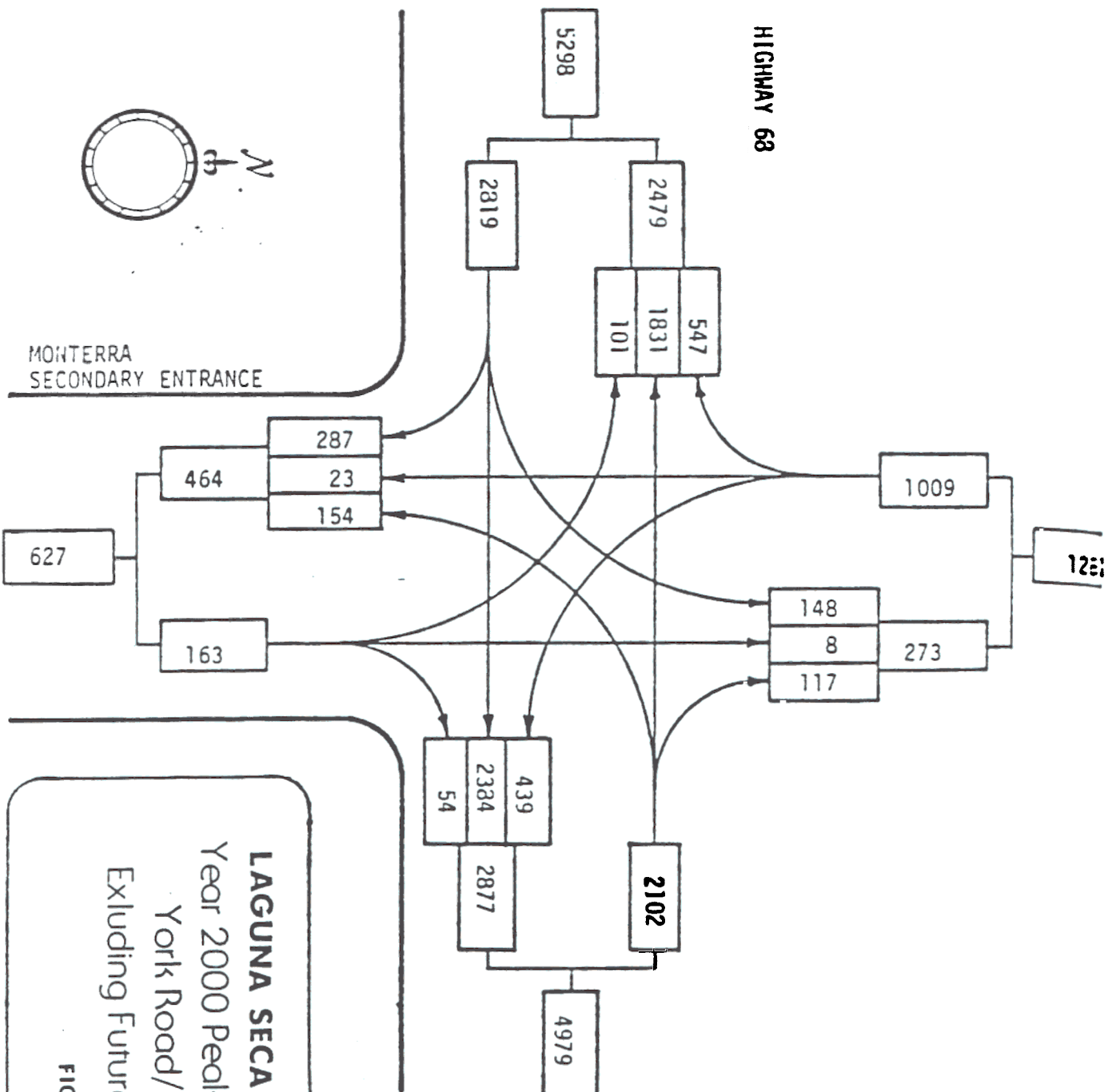

MONTERRA
SECONDARY ENTRANCE

LAGUNA SECA OFFICE PARK
 Year 2000 Peak Hour Volumes
 York Road/Highway 68
 Excluding Future Project Traffic

FIGURE 18

Source: William Dykko, Consulting Engineers

Legend
 ADI - Average Daily Traffic

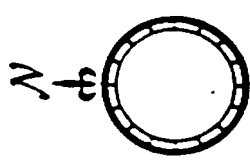
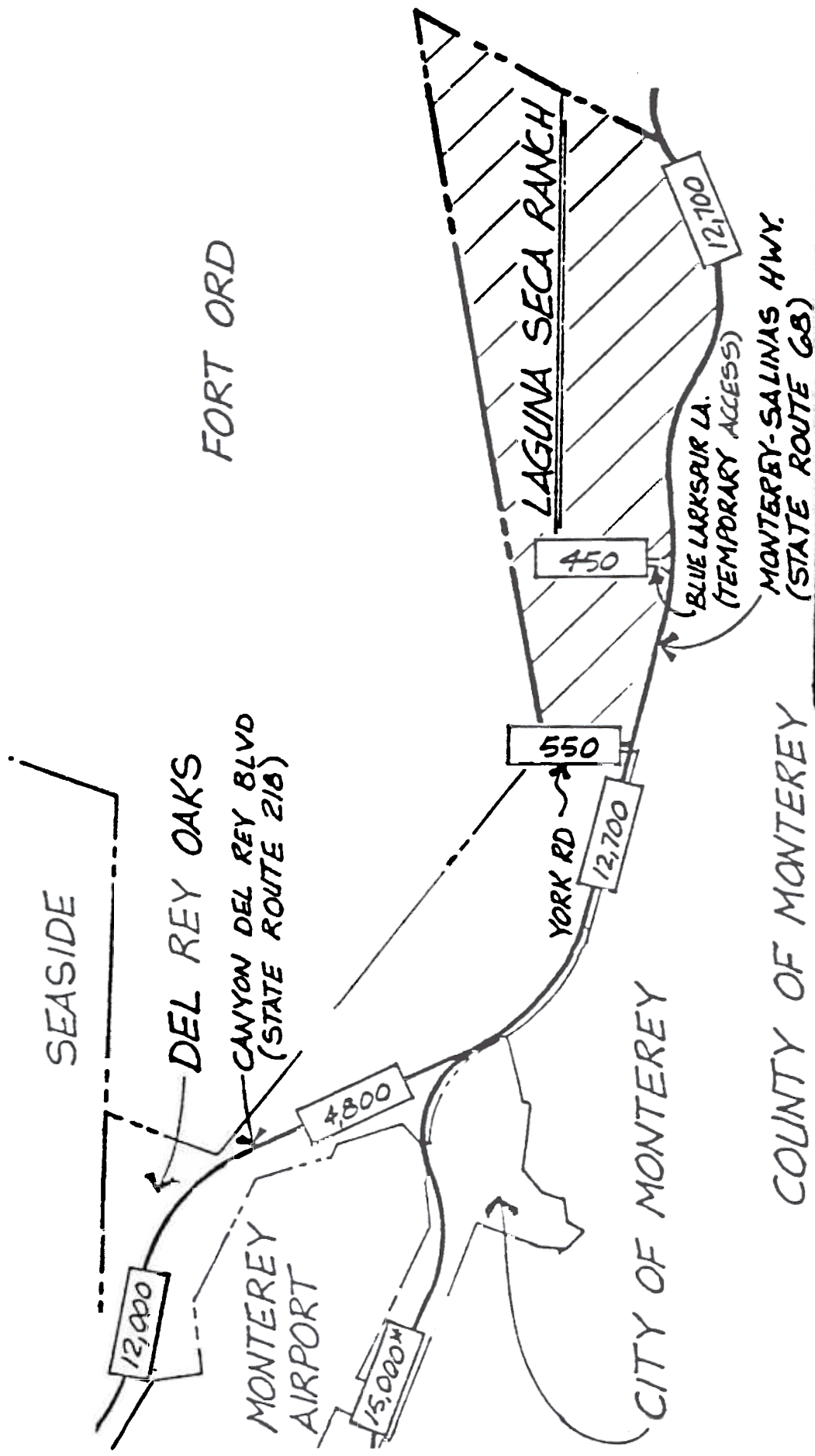

LEGEND
 ADT - Average Daily Traffic
 *Lost of Hwy 1

LAGUNA SECA OFFICE PARK
 Traffic Flow Map
 1980 (Existing) Volumes
 Fig. 19

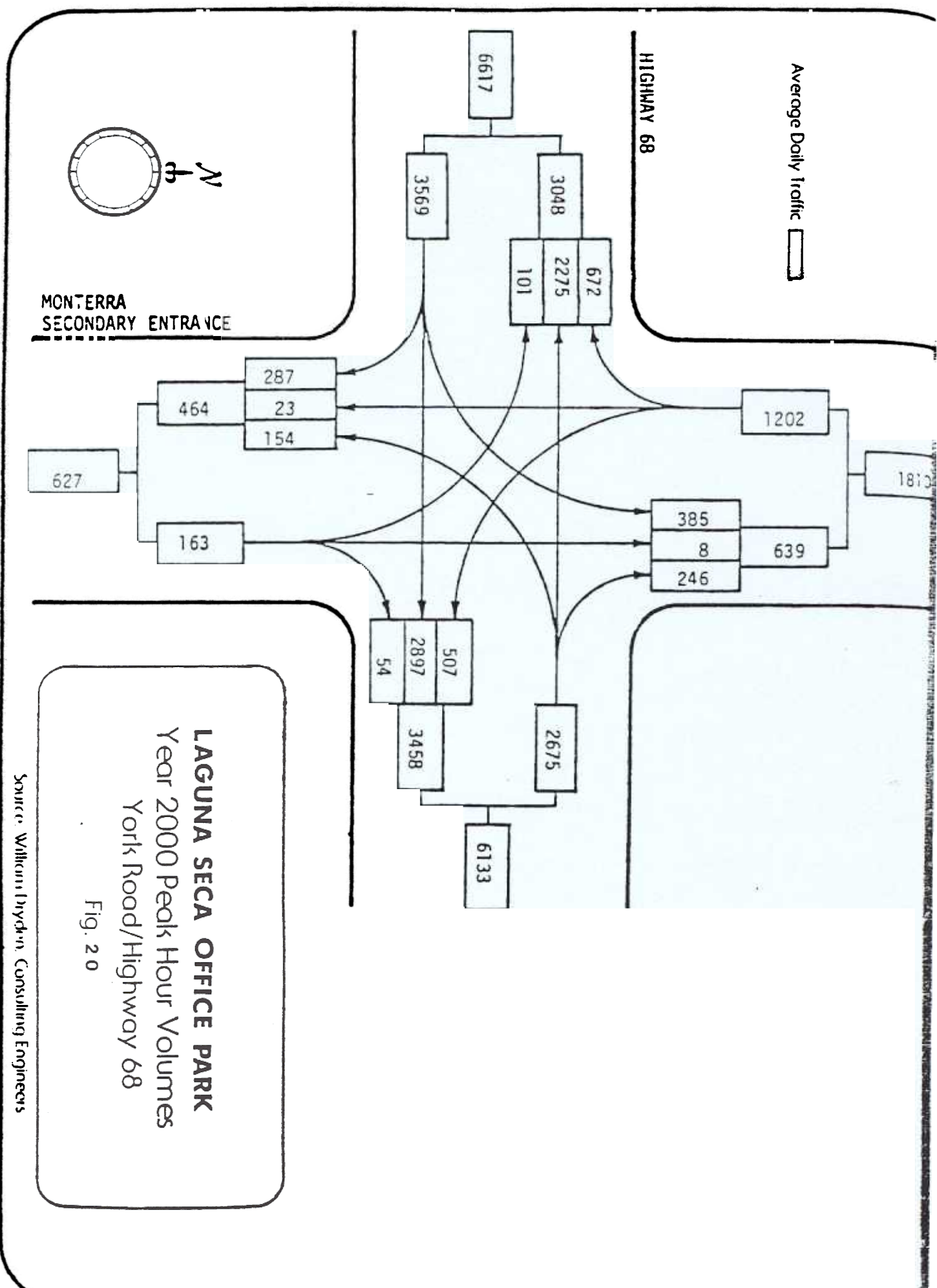

Project Traffic Generation and Distribution

On-site access to the project site will be provided by York Road which is an existing entrance to the property. Blue Larkspur Lane will be closed to through traffic after development occurs.

According to both Traffic Engineers, Dryden and Nickelson, expected project-generated traffic is 3,120 trips per day and 3,900 average trips per day (ADT).

It has been pointed out by Carl Hooper, Project Engineer for Laguna Seca Office Park, that with a small change in transportation mode, the average trips per day could be reduced by 30% to approximately 2,500 average trips per day. He suggests that 20% of the employees would car pool, 10% would use buses and the remaining 70% use individual cars. Also included in the 2,500 ADT would be 400 customer trips per day. The breakdown would be as follows:

70% in individual cars	= 700 employees X 2.5 trips	= 1,750
20% in car pools	= 200 employees X 2.0 trips	= 400
10% in buses	= 100 employees X 0 trips	= 0
	200 customers X 2.0 trips	= 400
	TOTAL TRIPS	= 2,550

Impacts

Traffic increases external to the project could include 85,120 vehicle trips added over the next 25 to 30 years from various developments near Laguna Seca Office Park plus about a two percent per annum increase due to regional growth.

The professional Office Park development will produce between 2,500 to 3900 average daily trips (ADT).

According to the TKJM Report, near the proposed Office Park Highway 68 presently operates at a D L.O.S., with a v/c ratio of .67. The expected level of service in the year 2000 on a proposed six-lane expressway will be F with a v/c ratio of 1.01 without project traffic.

Traffic signals will be warranted at the project entrance. Additional study of the necessary signal control and intersection geometrics will be required when the type of Highway 68 facility to be constructed is determined.

Additional examination of traffic control will be necessary at York Road/Blue Larkspur Road intersection at the time of development.

Mitigation Measures

Traffic signalization should be provided. Additional study is necessary for the intersection of York Road and Highway 68. Determination of signal phasing, location, timing and intersection geometrics will be required. It has been determined by Public Works that Larkspur Road will be closed.

48. Care should be taken to provide adequate sight distances at all on-site intersections.

Additional study by the County Public Works Department should be made of the usage of Ryan Ranch roads as access routes to Highway 218 from York Road.

Additional bus transit service should be provided to and from Monterey.

The Office Park business organizations should cooperate with one another to provide flexible or staggered business hours and to assist in the formation of carpools or vanpools.

2.8 Air Quality

The northern portion of the Salinas Valley, to which this area is connected, is considered a part of the same air basin as all of the coastal areas of Monterey County. It is identified as the North Central Coast Air Basin. Motor vehicles are the largest source of gaseous pollutants in the North Coastal basins. Carbon monoxide, nitrogen oxides and hydrocarbons comprise the basic category of air pollutants emitted from automobiles. Though the emissions from a particular car do not seem exorbitant, it is the volume which accounts for the pollution potential.

Under the Federal Prevention of Significant Deterioration Program (PSD), areas which are maintaining federal air quality standards currently are being classified. Monterey County presently fails to meet standards designated as Non-Attainment Areas, and is required to prepare a Non-Attainment Plan. A Non-Attainment Plan has been prepared by the Association of Monterey Bay Area Governments (AMBAG); it proposes general measures regarding traffic flow and transit services which should enable this district to meet federal standards by 1982. In addition, general policies pertaining to mobile-source and land-use controls are suggested. Although there are no specific policies for North Monterey County, the plan recommends that all large residential developments be reviewed by AMBAG according to the A95 review process.

Appendix B
Raw Traffic Count Data

Location: Blue Larkspur Ln E/O York Rd
 Date Range: 9/17/2019 - 9/23/2019
 Site Code: 01

Time	Tuesday		Wednesday		Thursday		Friday		Saturday		Sunday		Monday		Mid-Week Average	
	EB	Total	EB	Total	EB	Total	EB	Total	EB	Total	EB	Total	EB	Total	EB	Total
12:00 AM	0	1	1	1	1	1	1	2	-	-	-	-	-	-	1	1
1:00 AM	0	0	0	1	1	0	0	0	-	-	-	-	-	-	0	0
2:00 AM	1	2	1	0	1	0	0	0	-	-	-	-	-	-	1	0
3:00 AM	0	2	2	1	2	2	3	5	-	-	-	-	-	-	1	2
4:00 AM	1	2	1	1	2	1	1	2	-	-	-	-	-	-	1	1
5:00 AM	5	4	9	4	7	11	4	10	-	-	-	-	-	-	4	6
6:00 AM	38	6	44	41	7	48	41	11	52	-	-	-	-	-	40	8
7:00 AM	134	49	183	121	47	168	129	50	179	-	-	-	-	-	128	49
8:00 AM	147	56	203	159	48	207	174	49	223	-	-	-	-	-	160	51
9:00 AM	122	57	179	143	81	224	117	65	182	-	-	-	-	-	127	68
10:00 AM	75	96	171	93	81	174	112	89	201	-	-	-	-	-	93	89
11:00 AM	77	87	164	82	109	191	84	108	192	-	-	-	-	-	81	101
12:00 PM	78	107	185	81	100	181	87	104	191	-	-	-	-	-	82	104
1:00 PM	106	73	179	122	89	211	95	97	192	-	-	-	-	-	108	86
2:00 PM	87	100	187	98	107	205	78	91	169	-	-	-	-	-	88	99
3:00 PM	71	106	177	79	92	171	83	109	192	-	-	-	-	-	78	102
4:00 PM	60	140	200	48	139	187	52	130	182	-	-	-	-	-	53	136
5:00 PM	43	113	156	38	126	164	44	117	161	-	-	-	-	-	42	119
6:00 PM	18	44	62	15	37	52	15	28	43	-	-	-	-	-	16	36
7:00 PM	17	29	46	20	21	41	24	20	44	-	-	-	-	-	20	23
8:00 PM	15	14	29	9	9	18	14	7	21	-	-	-	-	-	13	10
9:00 PM	5	5	10	8	10	18	3	5	8	-	-	-	-	-	5	7
10:00 PM	3	3	6	1	0	1	5	3	8	-	-	-	-	-	3	2
11:00 PM	2	0	2	2	0	2	2	1	3	-	-	-	-	-	2	0
Total	1,105	1,094	2,199	1,168	1,113	2,281	1,167	1,095	2,262	-	-	-	-	-	1,147	1,101
Percent	50%	50%	51%	49%	52%	48%	52%	48%	48%	-	-	-	-	-	51%	49%
AM Peak	08:00	10:00	08:00	08:00	11:00	09:00	08:00	11:00	08:00	-	-	-	-	-	08:00	11:00
Vol.	147	96	203	159	109	224	174	108	223	-	-	-	-	-	160	101
PM Peak	13:00	16:00	13:00	13:00	16:00	13:00	13:00	16:00	13:00	-	-	-	-	-	13:00	16:00
Vol.	106	140	200	122	139	211	95	130	192	-	-	-	-	-	108	136

1. Mid-week average includes data between Tuesday and Thursday.

Location: Blue Larkspur Ln Opposite of 9833 Blue Larkspur Ln
 Date Range: 9/17/2019 - 9/23/2019
 Site Code: 02

Time	Tuesday			Wednesday			Thursday			Friday			Saturday			Sunday			Monday			Mid-Week Average		
	9/17/2019	9/18/2019	9/19/2019	9/18/2019	9/19/2019	9/20/2019	9/19/2019	9/20/2019	9/21/2019	9/22/2019	9/23/2019	9/21/2019	9/22/2019	9/23/2019	9/23/2019	9/23/2019	9/23/2019	9/23/2019	9/23/2019	9/23/2019	9/23/2019	9/23/2019	9/23/2019	
12:00 AM	0	0	0	1	0	1	0	0	0	-	-	-	-	-	-	-	-	-	-	-	-	-	-	-
1:00 AM	0	0	0	0	1	1	0	0	0	-	-	-	-	-	-	-	-	-	-	-	-	-	-	-
2:00 AM	1	1	2	1	0	1	0	0	0	-	-	-	-	-	-	-	-	-	-	-	-	-	-	-
3:00 AM	0	1	1	1	1	2	2	2	4	-	-	-	-	-	-	-	-	-	-	-	-	-	-	-
4:00 AM	1	1	2	0	1	1	1	1	2	-	-	-	-	-	-	-	-	-	-	-	-	-	-	-
5:00 AM	0	4	4	1	6	7	0	6	6	-	-	-	-	-	-	-	-	-	-	-	-	-	-	-
6:00 AM	7	5	12	7	6	13	5	10	15	-	-	-	-	-	-	-	-	-	-	-	-	-	-	-
7:00 AM	25	34	59	20	29	49	17	25	42	-	-	-	-	-	-	-	-	-	-	-	-	-	-	-
8:00 AM	41	19	60	34	18	52	43	14	57	-	-	-	-	-	-	-	-	-	-	-	-	-	-	-
9:00 AM	29	25	54	28	18	46	29	21	50	-	-	-	-	-	-	-	-	-	-	-	-	-	-	-
10:00 AM	21	23	44	25	28	53	21	32	53	-	-	-	-	-	-	-	-	-	-	-	-	-	-	-
11:00 AM	26	27	53	30	35	65	23	28	51	-	-	-	-	-	-	-	-	-	-	-	-	-	-	-
12:00 PM	21	24	45	19	28	47	27	28	55	-	-	-	-	-	-	-	-	-	-	-	-	-	-	-
1:00 PM	27	35	62	27	29	56	25	27	52	-	-	-	-	-	-	-	-	-	-	-	-	-	-	-
2:00 PM	26	28	54	42	30	72	28	24	52	-	-	-	-	-	-	-	-	-	-	-	-	-	-	-
3:00 PM	26	29	55	27	26	53	34	31	65	-	-	-	-	-	-	-	-	-	-	-	-	-	-	-
4:00 PM	24	25	49	18	31	49	31	32	63	-	-	-	-	-	-	-	-	-	-	-	-	-	-	-
5:00 PM	14	21	35	25	28	53	18	37	55	-	-	-	-	-	-	-	-	-	-	-	-	-	-	-
6:00 PM	14	7	21	7	10	17	10	10	20	-	-	-	-	-	-	-	-	-	-	-	-	-	-	-
7:00 PM	9	11	20	12	6	18	19	8	27	-	-	-	-	-	-	-	-	-	-	-	-	-	-	-
8:00 PM	8	6	14	6	4	10	9	4	13	-	-	-	-	-	-	-	-	-	-	-	-	-	-	-
9:00 PM	3	3	6	5	1	6	3	3	6	-	-	-	-	-	-	-	-	-	-	-	-	-	-	-
10:00 PM	2	0	2	0	0	0	5	2	7	-	-	-	-	-	-	-	-	-	-	-	-	-	-	-
11:00 PM	2	0	2	2	0	2	1	1	2	-	-	-	-	-	-	-	-	-	-	-	-	-	-	-
Total	327	329	656	338	336	674	351	346	697	-	-	-	-	-	-	-	-	-	-	-	-	-	-	-
Percent	50%	50%	50%	50%	50%	50%	50%	50%	50%	-	-	-	-	-	-	-	-	-	-	-	-	-	-	-
AM Peak	08:00	07:00	08:00	08:00	11:00	11:00	08:00	10:00	08:00	-	-	-	-	-	-	-	-	-	-	-	-	-	-	-
Vol.	41	34	60	34	35	65	43	32	57	-	-	-	-	-	-	-	-	-	-	-	-	-	-	-
PM Peak	13:00	13:00	13:00	14:00	16:00	14:00	15:00	17:00	15:00	-	-	-	-	-	-	-	-	-	-	-	-	-	-	-
Vol.	27	35	62	42	31	72	34	37	65	-	-	-	-	-	-	-	-	-	-	-	-	-	-	-

1. Mid-week average includes data between Tuesday and Thursday.



Location: Wilson Rd, W/O York Rd
 Date Range: 7/23/2019 - 7/29/2019
 Site Code: 02

Time	Tuesday 7/23/2019		Wednesday 7/24/2019		Thursday 7/25/2019		Friday 7/26/2019		Saturday 7/27/2019		Sunday 7/28/2019		Monday 7/29/2019		Mid-Week Average			
	EB	WB	Total	EB	WB	Total	EB	WB	Total	EB	WB	Total	EB	WB	Total	EB	WB	Total
12:00 AM	1	5	6	2	3	5	4	4	3	7	-	-	-	-	-	2	4	6
1:00 AM	1	3	4	1	3	4	4	4	4	8	-	-	-	-	-	2	3	5
2:00 AM	5	2	7	2	3	5	3	3	2	5	-	-	-	-	-	3	2	6
3:00 AM	1	2	3	4	1	5	6	2	8	-	-	-	-	-	4	2	5	
4:00 AM	5	13	18	3	8	11	7	8	15	-	-	-	-	-	5	10	15	
5:00 AM	15	41	56	16	46	62	16	49	65	-	-	-	-	-	16	45	61	
6:00 AM	49	124	173	39	128	167	55	161	216	-	-	-	-	-	48	138	185	
7:00 AM	99	265	364	90	281	371	111	237	348	-	-	-	-	-	100	261	361	
8:00 AM	145	259	404	149	262	411	163	239	402	-	-	-	-	-	152	253	406	
9:00 AM	150	161	311	154	157	311	140	164	304	-	-	-	-	-	148	161	309	
10:00 AM	132	137	269	123	137	260	133	139	272	-	-	-	-	-	129	138	267	
11:00 AM	151	123	274	155	96	251	154	148	302	-	-	-	-	-	153	122	276	
12:00 PM	167	127	294	155	127	282	142	137	279	-	-	-	-	-	155	130	285	
1:00 PM	121	116	237	129	121	250	163	122	285	-	-	-	-	-	138	120	257	
2:00 PM	167	152	319	167	131	298	179	147	326	-	-	-	-	-	171	143	314	
3:00 PM	225	157	382	222	135	357	244	137	381	-	-	-	-	-	230	143	373	
4:00 PM	239	171	410	218	154	372	219	186	405	-	-	-	-	-	225	170	396	
5:00 PM	210	138	348	197	159	356	182	163	345	-	-	-	-	-	196	153	350	
6:00 PM	62	28	90	81	57	138	83	53	136	-	-	-	-	-	75	46	121	
7:00 PM	35	21	56	39	25	64	61	19	80	-	-	-	-	-	45	22	67	
8:00 PM	27	16	43	39	15	54	44	14	58	-	-	-	-	-	37	15	52	
9:00 PM	10	9	19	16	9	25	28	10	38	-	-	-	-	-	18	9	27	
10:00 PM	11	4	15	10	8	18	13	8	21	-	-	-	-	-	11	7	18	
11:00 PM	5	5	10	6	6	12	12	3	15	-	-	-	-	-	8	5	12	
Total	2,033	2,079	4,112	2,017	2,072	4,089	2,166	2,155	4,321	-	-	-	-	-	2,072	2,102	4,174	
Percent	49%	51%	50%	49%	51%	50%	50%	50%	50%	-	-	-	-	-	50%	50%	50%	-
AM Peak	11:00	07:00	08:00	11:00	07:00	08:00	08:00	08:00	08:00	08:00	-	-	-	-	-	11:00	07:00	08:00
Vol.	151	265	404	155	281	411	163	239	402	-	-	-	-	-	153	261	406	
PM Peak	16:00	16:00	16:00	15:00	17:00	16:00	15:00	16:00	16:00	16:00	-	-	-	-	-	15:00	16:00	16:00
Vol.	239	171	410	222	159	372	244	186	405	-	-	-	-	-	230	170	396	

1. Mid-week average includes data between Tuesday and Thursday.

Project Manager: (415) 310-6469
 project.manager.ca@idaxdata.com

LOCATION: York Rd -- SR 68
CITY/STATE: Monterey, CA

QC JOB #: 13723609
DATE: Wed, Feb 24 2016

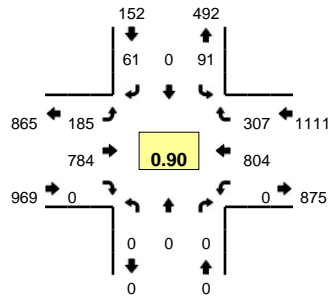

Peak-Hour: 7:20 AM -- 8:20 AM
Peak 15-Min: 7:35 AM -- 7:50 AM

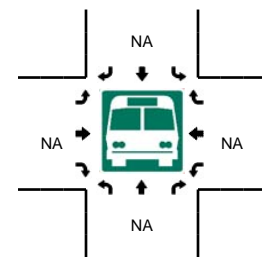
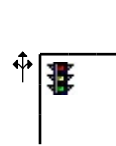
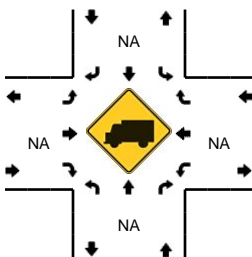
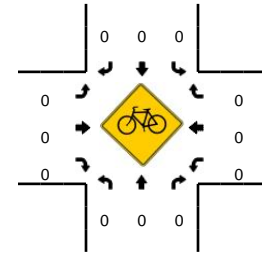
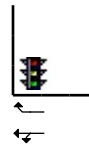
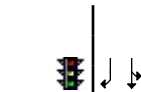
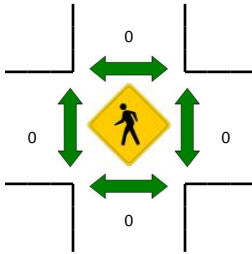
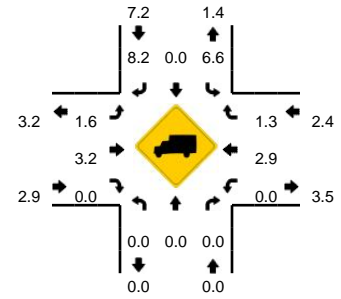

5-Min Count Period Beginning At	York Rd (Northbound)				York Rd (Southbound)				SR 68 (Eastbound)				SR 68 (Westbound)				Total	Hourly Totals
	Left	Thru	Right	U	Left	Thru	Right	U	Left	Thru	Right	U	Left	Thru	Right	U		
7:00 AM	0	0	0	0	7	0	2	0	5	41	0	0	3	90	39	0	187	
7:05 AM	0	0	0	0	1	0	3	0	7	46	0	0	0	62	28	0	147	
7:10 AM	0	0	0	0	9	0	1	0	1	46	0	0	0	62	20	0	139	
7:15 AM	0	0	0	0	2	0	3	0	7	60	0	0	0	66	20	0	158	
7:20 AM	0	0	0	0	5	0	3	0	12	61	0	0	0	82	26	0	189	
7:25 AM	0	0	0	0	7	0	3	0	8	50	0	0	0	84	31	0	183	
7:30 AM	0	0	0	0	9	0	5	0	11	70	0	0	0	65	29	0	189	
7:35 AM	0	0	0	0	7	0	9	0	20	66	0	0	0	77	26	0	205	
7:40 AM	0	0	0	0	10	0	8	0	9	78	0	0	0	90	29	0	224	
7:45 AM	0	0	0	0	13	0	4	0	7	56	0	0	0	81	33	0	194	
7:50 AM	0	0	0	0	5	0	2	0	18	78	0	0	0	77	25	0	205	
7:55 AM	0	0	0	0	9	0	7	0	17	59	0	0	0	48	31	0	171	2191
8:00 AM	0	0	0	0	10	0	1	0	17	63	0	0	0	48	16	0	155	2159
8:05 AM	0	0	0	0	3	0	10	0	22	67	0	0	0	53	17	0	172	2184
8:10 AM	0	0	0	0	8	0	5	0	15	64	0	0	0	55	22	0	169	2214
8:15 AM	0	0	0	0	5	0	4	0	29	72	0	0	0	44	22	0	176	2232
8:20 AM	0	0	0	0	16	0	10	0	20	46	0	0	0	39	19	0	150	2193
8:25 AM	0	0	0	0	11	0	7	0	14	44	0	0	0	60	29	0	165	2175
8:30 AM	0	0	0	0	8	0	6	0	18	55	0	0	0	70	39	0	196	2182
8:35 AM	0	0	0	0	18	0	14	0	9	57	0	0	0	53	22	0	173	2150
8:40 AM	0	0	0	0	9	0	10	0	10	52	0	0	0	56	22	0	159	2085
8:45 AM	0	0	0	0	4	0	6	0	13	49	1	0	0	67	18	0	158	2049
8:50 AM	0	0	0	0	12	0	11	0	11	56	0	0	0	58	21	0	169	2013
8:55 AM	0	0	0	0	6	0	6	0	12	39	0	0	0	57	19	0	139	1981
Peak 15-Min Flowrates	Northbound				Southbound				Eastbound				Westbound				Total	
	Left	Thru	Right	U	Left	Thru	Right	U	Left	Thru	Right	U	Left	Thru	Right	U		
All Vehicles	0	0	0	0	120	0	84	0	144	800	0	0	0	992	352	0	2492	
Heavy Trucks	0	0	0	0	12	0	0	0	0	16	0	0	0	52	4	0	84	
Pedestrians	0	0	0	0	0	0	0	0	0	0	0	0	0	0	0	0	0	
Bicycles	0	0	0	0	0	0	0	0	0	0	0	0	0	0	0	0	0	
Railroad																		
Stopped Buses																		

Comments:

LOCATION: York Rd -- SR 68
CITY/STATE: Monterey, CA

QC JOB #: 13723610
DATE: Tue, Feb 23 2016

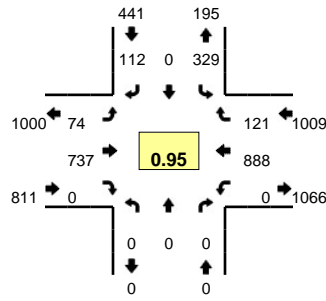

Peak-Hour: 4:30 PM -- 5:30 PM
Peak 15-Min: 4:50 PM -- 5:05 PM

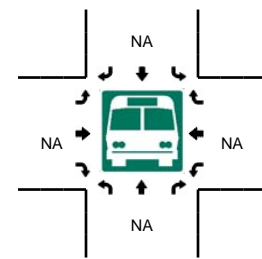
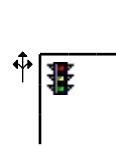
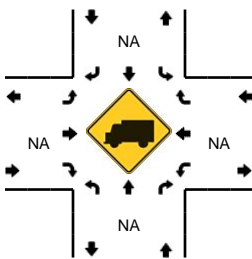
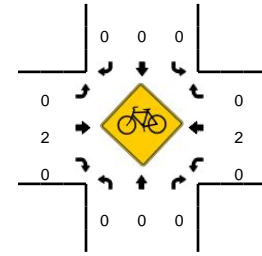
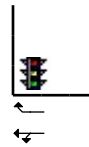
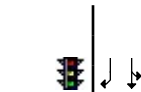
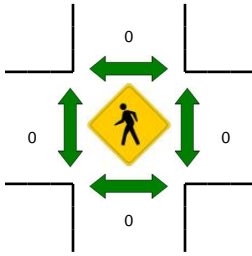
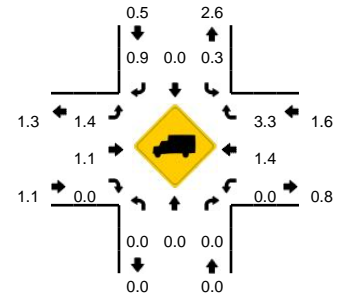

5-Min Count Period Beginning At	York Rd (Northbound)				York Rd (Southbound)				SR 68 (Eastbound)				SR 68 (Westbound)				Total	Hourly Totals
	Left	Thru	Right	U	Left	Thru	Right	U	Left	Thru	Right	U	Left	Thru	Right	U		
4:00 PM	0	0	0	0	25	0	13	0	7	69	0	0	0	53	14	0	181	
4:05 PM	0	0	0	0	22	0	8	0	7	80	0	0	0	69	7	0	193	
4:10 PM	0	0	0	0	40	0	9	0	3	83	0	0	0	68	4	0	207	
4:15 PM	0	0	0	0	31	0	11	0	10	60	0	0	0	48	7	0	167	
4:20 PM	0	0	0	0	22	0	8	0	3	65	0	0	0	72	4	0	174	
4:25 PM	0	0	0	0	14	0	4	0	8	42	0	0	0	75	9	0	152	
4:30 PM	0	0	0	0	19	0	4	0	6	50	0	0	0	74	16	0	169	
4:35 PM	0	0	0	0	35	0	6	0	8	55	0	0	0	66	12	0	182	
4:40 PM	0	0	0	0	24	0	7	0	5	62	0	0	0	78	12	0	188	
4:45 PM	0	0	0	0	31	0	5	0	5	64	0	0	0	65	9	0	179	
4:50 PM	0	0	0	0	22	0	15	0	13	73	0	0	0	70	10	0	203	
4:55 PM	0	0	0	0	26	0	11	0	7	66	0	0	0	86	16	0	212	2207
5:00 PM	0	0	0	0	35	0	10	0	7	70	0	0	0	57	3	0	182	2208
5:05 PM	0	0	0	0	36	0	12	0	5	61	0	0	0	75	5	0	194	2209
5:10 PM	0	0	0	0	22	0	15	0	6	61	0	0	0	77	10	0	191	2193
5:15 PM	0	0	0	0	27	0	12	0	5	59	0	0	0	73	11	0	187	2213
5:20 PM	0	0	0	0	35	0	10	0	3	61	0	0	0	81	8	0	198	2237
5:25 PM	0	0	0	0	17	0	5	0	4	55	0	0	0	86	9	0	176	2261
5:30 PM	0	0	0	0	18	0	10	0	2	71	0	0	0	59	6	0	166	2258
5:35 PM	0	0	0	0	16	0	11	0	4	76	0	0	0	69	7	0	183	2259
5:40 PM	0	0	0	0	17	0	5	0	3	43	0	0	0	77	5	0	150	2221
5:45 PM	0	0	0	0	13	0	5	0	3	63	0	0	0	73	5	0	162	2204
5:50 PM	0	0	0	0	10	0	2	0	5	67	0	0	0	70	6	0	160	2161
5:55 PM	0	0	0	0	14	0	8	0	4	45	0	0	0	42	5	0	118	2067
Peak 15-Min Flowrates	Northbound				Southbound				Eastbound				Westbound				Total	
	Left	Thru	Right	U	Left	Thru	Right	U	Left	Thru	Right	U	Left	Thru	Right	U		
All Vehicles	0	0	0	0	332	0	144	0	108	836	0	0	0	852	116	0	2388	
Heavy Trucks	0	0	0	0	0	0	4	0	4	8	0	0	0	16	0	0	32	
Pedestrians	0	0	0	0	0	0	0	0	0	0	0	0	0	0	0	0	0	
Bicycles	0	0	0	0	0	0	0	0	0	1	0	0	0	0	0	0	1	
Railroad																		
Stopped Buses																		

Comments: