



Monterey County Board of Supervisors

Board Order

168 West Alisal Street,
1st Floor
Salinas, CA 93901
831.755.5066
www.co.monterey.ca.us

A motion was made by Supervisor Luis A. Alejo, seconded by Supervisor John M. Phillips, to adopt Resolution No. 20 – 200 to:

Adopted Resolution No. 20 – 200:

- a. Certify that the Board considered an Addendum together with the previously certified Environmental Impact Report for the California Flats Solar Project (SCH#2013041031), pursuant to Section 15164 of the CEQA Guidelines;
- b. Approve amendment to the Use Permit for the California Flats Solar Project (approved of February 10, 2015, Resolution No. 15-027; Planning File No. PLN120294) to construct up to an 85 units Tesla Megapack battery energy storage system and associated infrastructure improvements, including approximately 7,243 cubic yards of cut and 1,489 cubic yards of fill, with remaining soil to be balanced or stockpiled onsite. The proposed modification is located entirely within the existing footprint of the California Flats Project, encompassing an area of approximately 3 acres specifically on Assessor's Parcel Numbers 424-181-014 and 424-181-015 and within the “solar development area” footprint;
- c. Adopt a Condition Compliance and Mitigation Monitoring Reporting Program to reflect new/amended conditions.

This project substantially conforms with the original permit for the California Flats Project and is subject to several mitigation measures of the original project. A resolution, including findings and evidence and eight (8) new conditions, including a condition detailing the mitigation measures from the original permit applicable to the amendment, is attached for consideration

PASSED AND ADOPTED on this 16th day of June 2020, by roll call vote:

AYES: Supervisors Alejo, Phillips, Lopez, Parker and Adams
NOES: None
ABSENT: None
(Government Code 54953)

I, Valerie Ralph, Clerk of the Board of Supervisors of the County of Monterey, State of California, hereby certify that the foregoing is a true copy of an original order of said Board of Supervisors duly made and entered in the minutes thereof of Minute Book 82 for the meeting June 16, 2020.

Dated: June 16, 2020
File ID: RES 20-087
Agenda Item No.: 14

Valerie Ralph, Clerk of the Board of Supervisors
County of Monterey, State of California

Joel Pablo

Joel G. Pablo, Deputy

*Before the Board of Supervisors in and for the
County of Monterey, State of California*

In the matter of the application of:

**CALIFORNIA FLATS SOLAR PROJECT-BATTERY ENERGY STORAGE SYSTEM
MODIFICATION- PERMIT AMENDMENT (HEARST CORPORATION)
(PLN120294-AMD1)**

Resolution No. 20 - 200

Resolution of the Monterey County Board of Supervisors:

- a. Certifying that the Board considered an addendum together with the previously certified California Flats Solar Project Environmental Impact Report (SCH #2013041031);
- b. Approving the amendment to the Use Permit for the California Flats Solar Project to construct up an to 85 unit Tesla Megapack battery energy storage system and associated infrastructure improvements, including approximately 7,243 cubic yards of cut and 1,489 cubic yards of fill, with remaining soil to be balanced or stockpiled onsite. The proposed modification is located entirely within the existing footprint of the California Flats Project, encompassing an area of approximately 3 acres specifically on Assessor's Parcel Numbers 424-181-014 and 424-181-015 and within the "solar development area" footprint; and
- c. Adopting a Condition Compliance and Mitigation Monitoring and Reporting Program

PLN120294-AMD1: APNs 424-181-014-000 and 424-181-015-000 Southeastern corner of Monterey County, approximately 7 miles southwest of Parkfield and 25 miles northeast of Paso Robles, east of Turkey Flats Road and north of State Highway 46 near borders of Monterey, San Luis Obispo, Kings and Fresno counties; South County Area Plan.....

California Flats Solar Project for a Battery Energy Storage System (PLN120294-AMD1) came on for public hearing before the Monterey County Board of Supervisors on June 16, 2020. Having considered all the written and documentary evidence, the administrative record, the staff report, and other evidence presented, the Monterey County Board of Supervisors finds and decides as follows:

FINDINGS

- 1. **FINDING:** The County has received and duly processed an amendment to the Use Permit for the California Flats Solar Project (RMA-Planning File No. PLN120294-AMD1)
- EVIDENCE:**
 - a) California Flats Solar LLC; Cal Flats BESS, LLC; and Cal Flats Solar 130, LLC ("Applicant") submitted a request for a Permit Amendment to RMA-Planning on March 6, 2020. Applicant leases the subject site from the Hearst Corporation, the owner of the real property.
 - b) Background: On February 10, 2015, the Monterey County Board of Supervisors certified an EIR, adopted CEQA findings and a statement of overriding considerations, and approved a Use Permit for the California Flats Solar Project (RMA-Planning File No. PLN120294; Board Resolutions No. 15-026 (certification of the EIR) and 15-027 (approval of Use Permit)) to allow for the duration of 34 years, the construction of a 280 Megawatt solar generating facility on an approximately 3,000 acre site including:

photovoltaic (PV) solar modules, two substations (approximately 6 acres each), a switching station (approximately 6 acres), a 4,000 square foot operations and maintenance building, and approximately 155 acre utility corridor, other infrastructure needed to serve the proposed project and grading of approximately 880,000 cubic yards of cut and 880,000 cubic yards of fill; and Adopt a Condition Compliance and Mitigation Monitoring and Reporting Plan.

- c) The use authorized by the original Use Permit has been constructed and is in operation.
- d) No previous extensions or amendments of the Use Permit (PLN120294) have been requested by or granted to the Applicant.
- e) The proposed modification is a permit amendment to the approved and constructed California Flats Solar Project (“Amendment”). The Amendment consists of the installation and operation of a Battery Energy Storage System (BESS) and associated substation improvements and grading. Construction of the Battery Energy Storage System is anticipated to take a total of approximately four to seven months. The proposed modification is located entirely within the existing 2,120-acre Solar Development Area, as approved in the original California Flats Solar Project. The actual footprint of the California Flats Solar Project is considerably less at 1,684 acres of the 2,120-acre Solar Development Area. The proposed modification is consistent with the 880,000 cubic yards cut and 880,000 cubic yards of fill allowed with the Use Permit. The total grading, inclusive of the proposed grading, is 893,880 cubic yards of cut and 540,299 cubic yards of fill. Grading (cut) is 1.5% over the 880,000 cubic yards analyzed in the EIR and approved in the Use Permit, and the Board finds that this 1.5% overage is in substantial conformance with the Use Permit. The components of the proposed project are described as follows:

Battery Energy Storage System: Installation of up to 85 Tesla Megapack battery units. Each group of four Megapack battery units would be installed on an approximately 75 foot long by 12 foot wide by two foot thick concrete pad. The concrete pad would be located entirely within a previously disturbed three (3) acre site located within the existing Solar Development Area evaluated in the California Flat Solar Project EIR. Each battery unit would be fully integrated with pre-installed components housed outside, in stand alone cabinets with air conditioning. Each battery unit would have six battery modules, stored in racks, capable of discharging 3,699 kW with a charge capacity of 3,162 kW. Surface excavation of approximately 2.3 acres with an approximate depth of up to six (6) feet would be required for the establishment of the concrete pads that would house the Megapack battery units.

CA Flats 60 Substation Modification: The modification also includes improvements to the existing Northern substation (CA Flats 60 Substation) to allow for additional energy to be converted from the Battery Energy Storage System. The substation would be constructed

on an approximately 104x160 foot area immediately adjacent to the existing northern substation.

Connection to the Existing Transmission System: Approximately 1,650 feet of overhead line comprised of seven steel poles would be installed between the Battery Energy Storage System and new CA Flats 60 Substation. A section of the overhead line will run underground, crossing transmission right of way for approximately 350 feet. The trench depth would be approximately 12 feet wide with 1:1 side slopes.

Grading: The Amendment is anticipated to disturb an area of approximately 2.5 acres, requiring approximately 7,243 cubic yards of cut and 1,489 cubic yards of fill. No grading material is expected to be hauled off-site. The balance of material, approximately 5,754 cubic yards, will be temporarily stockpiled on-site for future reuse by the property owner (Hearst Corporation). The stockpiled material will be used as part of on-going ranch maintenance related activities. The final location for soil deposition will be determined based on discussions between Hearst and the Applicant. There is an existing disturbed area south of the proposed Battery Energy Storage System Modification where soil was stockpiled previously. This area could be used for similar purposes as part of the project. Prior to any soil placement on-site, applicant would conduct pre-construction surveys of the soil deposition area and identify any recommendations consistent with the requirements of the California Flats Project. Condition of approval has been added to require on-site retention of the soil. **See Condition No. 7 in Attachment 1 of the June 16, 2020 Staff Report.**

As proposed, the use would not result in new impacts not previously considered in the original approval (See Finding No. 2 with supporting evidence).

- f) The following mitigation measures pursuant to BOS Resolution Nos. 15-026 and 15-027 apply to this Permit Amendment and shall be adhered to. **Condition No. 2** has been added as a Condition of Approval in **Attachment 1 of the June 16, 2020 Staff Report.**

AESTHETICS

- MM #2 - AES-3 Minimize Construction Lighting

AIR QUALITY

- MM #3 - AQ-2(A) Dust Control Measures
- MM #4 - AQ(B) Emission-Reduction Measures For Construction Equipment
- MM #5 - AQ-2(C) Tier 3 Construction Equipment
- MM #6 - AQ-6(A) Valley Fever Management Plan
- MM #7 - AQ-6(B) Additional Valley Fever Dust Suppression Measures
- MM #8 – Monterey County Health Department Notification

- MM #9 - AQ-6(D) Valley Fever Worker Training Program And Safety Measures
- MM #10 - AQ-6(E) Valley Fever Information Handout
- MM #11 - AQ-9 Construction Management Plan Requirements

BIOLOGICAL RESOURCES

- MM #12 - B-1(A) Nested Compensatory Mitigation
- MM #15 - B-1(D) Special Status Plant Species Avoidance And Minimization
- MM #16 - B-1(E) Compensatory Mitigation For Special Status Plant Species
- MM #17 - B-1(F) Preconstruction Survey For American Badger
- MM #18 - B-1(G) American Badger Avoidance And Minimization
- MM #19 - B-1(H) Preconstruction Surveys For San Joaquin Kit Fox
- MM #20 - B-1(I) San Joaquin Kit Fox Den Avoidance And Minimization Measures
- MM #21 B-1 (J) Compensatory Habitat Mitigation For San Joaquin Kit Fox
- MM #22 - B-1(K) Remove Wild Animals And Livestock Carcasses
- MM #23 - B-1(L) Preconstruction Surveys For Burrowing Owl
- MM #24 - b-1(M) Burrowing Owl Avoidance And Minimization Measures
- MM #25 - B-1(N) Compensatory Habitat Mitigation For Burrowing Owl
- MM #26 - B-1(O) Preconstruction Surveys For Coachwhip And Coast Horned Lizard
- MM #28 - B-1(Q) Bat Preconstruction Surveys And Avoidance
- MM #29 - B-1(R) Preconstruction Survey For Raptors And Other Special Status Bird
- MM #30 - B-1(S) Special Status Bird Species Impact Avoidance And Minimization
- MM #42 - B-1(ee) Construction Biological Monitoring
- MM #43 - B-1(ff) Special Status Animal Species General Avoidance Meas. And Const. Bmps
- MM #44 - B-1(gg) Worker Environmental Awareness Program
- MM #45 - B-2(a) Valley Needlegrass Grassland And Wildflower Field Habitat Mitigation
- MM #46 - B-2(b) Habitat Restoration And Revegetation Plan
- MM #47 - B-2(c) Project Vegetation And Invasive Species Management Plan
- MM #49 - B-2(e) Riparian/Stream Habitat Setbacks
- MM #50 - B-2(f) Stream Channel Avoidance And Minimization
- MM #51 - B-2(g) Directional Boring Avoidance And Minimization
- MM #52 - B-2(h) Show Streams And Riparian Habitat, And Associated Setbacks, On Const. Dwgs
- MM #53 - B-2(i) Riparian/Stream Mitigation
- MM #54 - B-3(a) Wetland Avoidance And Minimization

- MM #57 - B-3(d) Wetland Habitat Mitigation
- MM #58 - B-4(a) Pronghorn Calving Ground Avoidance And Minimization

CULTURAL & PALEONTOLOGICAL RESOURCES

- MM #62 - CR-1(a) Archaeological Site Avoidance
- MM #63 - CR-1(b) Site Capping And Data Indexing
- MM #64 - CR-1(c) Data Recovery Excavation
- MM #65 - CR-1(d) Archaeological Resource WEAP
- MM #66 - CR-1(e) Archaeological Resource Construction Monitoring
- MM #67 - CR-1(f) Native American Construction Monitoring
- MM #68 - CR-2 Previously Unidentified Archaeological Resources
- MM #69 - CR-4(a) Paleontological Resource Mitigation Plan
- MM #70 - CR-4(b) Paleontological Resource Construction Monitoring

HAZARDS & HAZARDOUS MATERIALS

- MM #72 - HAZ-3 Locate Underground Utilities
- MM #73 - HAZ-4(a) Final Fuel Management Plan
- MM #74 - HAZ-4(b) Emergency Access

HYDROLOGY AND WATER QUALITY

- HYD-2(a) Accidental Spill Control And Environmental Training
- MM #77 - HYD-2(b) Maintain Vehicles And Equipment

PUBLIC SERVICES

- MM #78 - PS-1(a) Construction Management Plan
- MM #79 - PS-1(b) Emergency Response Training
- MM #80 - PS-1(C) Fire Protection During Construction

TRANSPORTATION/TRAFFIC

- MM #81 - T-2 Friday Peak Hour Control Measures – Construction Phase

LONG-TERM IMPACTS

- MM #84 - LT-1 Worker Housing Program

- g) Public notice for this Amendment has been carried out pursuant to Monterey Code Chapter 21.78- Public Hearings. Notice of Public Hearing was published on June 4, 2020 in the Monterey County Weekly. On June 3, 2020, notices were mailed out to all property owners within 300 feet of the subject site and to persons who requested notice on the original Use Permit (PLN120294). On June 5, 2020 notices were posted in at least 3 different public places on and near the subject property.
- h) The application, project plans, and related support materials submitted by the project applicant to Monterey County RMA-

Planning for the original project and the proposed amendment found in Project File Nos. PLN120294 and PLN120294-AMD1.

2. **FINDING:** **CONSISTENCY / SITE SUITABILITY / NO VIOLATIONS -**
The Amendment, as conditioned, is consistent with the previously-approved Use Permit, as well as policies of the 2010 Monterey County General Plan and the South County Area Plan and other County health, safety, and welfare regulations related to land use development. The site is physically suitable for the use proposed, and no violations exist on the property.
- EVIDENCE:**
- a) The Amendment is consistent with the original permit action in that the original permit is for a commercial solar generating facility and the proposed minor amendment is a component of the use establishing a battery energy storage use of the generated solar power. The proposed area for the battery energy storage and infrastructure is to be located entirely within the existing 2,120-acre Solar Development Area, as approved in the original California Flats Solar Project. The proposed modification is consistent with the allowable 880,000 cubic yards cut and 880,000 cubic yards of fill, as the total grading, inclusive of the proposed grading for the modification is in substantial conformance at 893,880 cubic yards of cut and 540,299 cubic yards of fill. Grading (cut) is 1.5% over the 880,000 cubic yards analyzed in the EIR and approved in the Use Permit, deeming this 1.5% overage in substantial conformance of the Use Permit. Therefore, the proposed permit amendment is in keeping with the previous action of the Monterey County Board of Supervisors (Resolution No. RMA-Planning File No. PLN120274). All potential impacts were already assessed in the original permit action, and the amendment is in keeping with the action of the appropriate authority.
 - b) The property is located at the Southeastern corner of Monterey County, approximately 7 miles Southwest of Parkfield and 25 miles northeast of Paso Robles, east of Turkey Flats Road and north of State Highway 46 near borders of Monterey, San Luis Obispo, Kings and Fresno counties; South County Area Plan (Assessor's Parcel Numbers: 424-181-014-000 and 424-181-015-000). The zoning of the parcels are Farmlands/160 acre minimum (F/160), which allows for public and quasi-public uses, including public utilities with the granting of a Use Permit. In this case, the County determined that a Permit Amendment to the previously approved Use Permit (RMA-Planning File No. PLN120294) is the applicable and appropriate entitlement to consider for the changes to the project scope. Therefore, the proposed project is an allowed land use for this site.
 - c) No conflicts were found to exist. Although communications were received during the course of review of the project indicating inconsistencies with the text, policies, and/or regulations in the applicable MCC, the issues received were resolved. See Finding, 3.
 - d) The subject parcels, Assessor's Parcel Numbers (APN) 424-181-014-000 and 424-181-015-000, were included as part of the California

Flats Solar Project which had a total of 33 APNs. Therefore, the County recognizes the subject property as a legal lot of record.

- e) Monterey County RMA-Planning and RMA-Building Services records were reviewed, and the County is not aware of any violations existing on the subject property.
- f) The project does not warrant referral to a Land Use Advisory Committee (LUAC) based on the current review guidelines adopted by the Monterey County Board of Supervisors per Resolution 15-043 because the proposed amendment does not present substantial changes to identified environmental impacts previously discussed and addressed in the EIR (SCH#2013041031) adopted for the original Cal-Flats Solar Project.
- g) The application, project plans, and related support materials submitted by the project applicant to Monterey County RMA-Planning for the original project and the proposed amendment found in Project File Nos. PLN120294 and PLN120294-AMD1.

3. **FINDING:**

ORIGINALLY PROCESSED AS MINOR AMENDMENT/OPPOSITION RECEIVED- ELEVATED TO A PUBLIC HEARING- This application was originally processed as a Minor Amendment, pursuant to Monterey County Code Section 21.74.120.A., and was scheduled for administrative approval without a public hearing by the RMA-Chief of Planning on May 20, 2020. As part of the public noticing requirements for minor amendments, notices to all property owners within 300 feet of the property and to persons who requested notice on the original use permit (PLN120294) were notified of the project proposal and of the County's intent to administratively approve the project on May 20, 2020. Prior to May 20, 2020, staff received written objections from a concerned neighbor regarding potential noise and visual impacts and from a law firm representing union interest regarding Valley Fever concerns, requiring a public hearing.

EVIDENCE:

- a) The subject project was originally processed as a Minor Amendment pursuant to MCC Section 21.74.120.A. A project qualifies for a minor amendment process if in the opinion of the Director of Planning, the amendment is of a minor nature: 1) with no environmental impacts, 2) with no increase in the severity of environmental impacts already identified, 3) generally in keeping with the action of the appropriate authority, 4) that would have only an inconsequential effect on land in relation to the approved permit, and 5) would meet all the relevant site development standards.
- b) The minor amendment process requires notices of the pending approval of the minor amendment to be posted on-site and be mailed to all interested parties (300-foot radius from the project site and any other known interested party list). If no written objections are received by County staff, the approval of the project shall be final. If objections are received, the amendment shall be considered under MCC Section 21.74.120.B, which states that if in the opinion of the Director of Planning, the proposed amendment does not qualify for a "minor amendment" the proposed amendment shall be taken to the

decision making body of the original permit and processed consistent with the original permit procedures. County staff received two objections to the project. See **Attachment F of the June 16, 2020 Staff Report** (Van Boxtel-Opposition) and **Attachment H of the June 16, 2020 Staff Report** (Adams, Broadwell, Joseph & Cardozo , Attorneys at Law-Opposition). After outreach to these parties from staff and the applicant, the parties' concerns were resolved and both oppositions were retracted in writing by the parties. See **Attachment G** of the June 16, 2020 Staff Report (Van Boxtel Opposition Retraction) and **Attachment I** of the June 16, 2020 Staff Report (Adams, Broadwell, Joseph & Cardozo , Attorneys at Law-Opposition Retraction) for retraction of opposition communications.

- c) Because one of opposition comments was CEQA related (the Adams, Broadwell, Joseph & Cardozo opposition), it is the determination of the Chief of RMA-Planning to refer this project before the Board of Supervisors at a public hearing.
- d) The written objections were from a concerned neighbor regarding potential noise and visual impacts and the other from a law firm representing union interest regarding Valley Fever concerns. These concerns were later retracted in writing. The following is a summary of the comments, how the concerns were addressed and the comment retractions:

Van Boxtel, Neighbor- On May 18, 2020, staff received an email (see **Attachment F of the June 16, 2020 Staff Report**) from Michelle Van Boxtel objecting to the project amendment citing the following concerns: not familiar with actual project location, size of battery packs and any potential impacts relating to private views, noise, colors and lighting. Staff contacted Ms. Van Boxtel and provided application material, such as project plans, project narrative and CEQA analysis. The applicant also contacted Ms. Van Boxtel and shortly thereafter a site visit of the project site was arranged. Once familiar with the project and the project site, Ms. Van Boxtel and the applicant agreed on privacy screening methods along the proposed battery packs so that it would not impact Ms. Van Boxtel's private views. Private views are not protected in the County and therefore, no County policies exists requiring a condition of approval. However, the applicant was amenable to a screening condition that resolved the concerns of Ms. Van Boxtel. *Condition No. 6- Good Neighbor Screening* (See **Attachment A, Exhibit 1 to the June 16, 2020 Staff Report**) has been added as a project condition requiring the applicant to install screening on the northern and western boundaries of the Battery Energy Storage System with mature trees and vegetation and with fencing with privacy slats. Staff confirmed with Ms. Van Boxtel that the condition language was satisfactory and that there were no unresolved issues. She then sent a second email confirming withdrawal of her opposition. See **Attachment G to the June 16, 2020 Staff Report**.

Adams, Broadwell, Joseph & Cardozo, Attorneys at Law, on behalf of California Unions for Reliable Energy (CURE)- On May 19,

2020, staff received a letter from attorney representing CURE in opposition to the project citing failure of the County to conduct additional environmental review that would address “the significant increase in Valley Fever identified since the publication of the prior EIR” and included an article regarding Valley Fever cases in the Cal-Flats Development. See **Attachment H to the June 16, 2020 Staff Report**. In response, the County’s environmental consultant, Denise Duffy & Associates (DD&A) prepared a response which indicated the reasons why additional environmental analysis is not warranted. See **Attachment J to the June 16, 2020 Staff Report** for letter. On, May 22, 2020, Nicole Fowler, Supervising Registered Environmental Health Specialist with Monterey County Health Department forwarded the CURE letter along with DD&As response, current Valley Fever Response Program and other related documents to Dr. Edward Moreno, Monterey County Public Health Officer for his review of information and a determination of adequacy of the existing mitigation measures and plans in place for the existing Use Permit and subsequent project amendment application (see **Attachment E of June 16, 2020 Staff Report** for Original Resolution with Mitigation Program). Dr. Moreno replied by email on May 24, 2020, that the article that the opposition included in their opposition letter does not represent information about risk exposure that was not already known to County’s Public Health and determined that if followed, the existing Valley Fever Mitigation Measures and programs in place for the Cal Flats project were adequate and the proposed amendment should not represent a risk exposure to Valley Fever that is different than the risk exposure to Valley Fever during the original project construction. See email chain in **Attachment K of the June 16, 2020 Staff Report**. Before the County could respond to the opposing party with a determination that no new information related to Valley Fever was merited and that the County’s existing Valley Fever programs and mitigation measures were adequate and sufficient for the proposed amendment, on May 26, 2020, the law firm submitted their retraction of their opposition (see **Attachment I of the June 16, 2020 Staff Report**) citing that CURE and the applicants entered into a settlement agreement to ensure that the existing Valley Fever measures would be implemented in connection with the proposed modification. Regardless of the settlement agreement between CURE and the project applicant, the County determines that there is no new information about risk exposure that was not already known to County’s Public Health and that the existing programs and mitigation measures related to Valley Fever are adequate for the original project and the subject project modification.

4. **FINDING:**

HEALTH AND SAFETY - The establishment, maintenance, or operation of the project applied for will not under the circumstances of this particular case be detrimental to the health, safety, peace, morals, comfort, and general welfare of persons residing or working in the neighborhood of such proposed use, or be detrimental or

injurious to property and improvements in the neighborhood or to the general welfare of the County.

- EVIDENCE:**
- a) The Amendment was reviewed by RMA-Planning, CalFire (Art Black), RMA-Public Works, RMA-Environmental Services and Environmental Health Bureau (EHB). Conditions recommended by RMA-Planning and RMA-Environmental Services were incorporated to ensure that the project will not have an adverse effect on the health, safety, and welfare of persons either residing or working in the neighborhood.
 - b) The application, plans, and supporting materials submitted by the project applicant to Monterey County RMA-Planning for the original project and the proposed amendment found in Project File Nos. PLN120294 and PLN120294-AMD1.

5. **FINDING:** **CEQA** – In accordance with CEQA Guidelines Section 15164(d), the Monterey County Board of Supervisors considered an Addendum together with the California Flats Solar Project FEIR (SCH#2013041031) prior to approving this Permit Amendment. (**Attachment B** to the June 16, 2020 Staff Report to the Monterey County Board of Supervisors) The Amendment requires minor additions due to the addition to the project authorized by this Amendment, but none of the conditions described in CEQA Guidelines Section 15162 calling for preparation of a subsequent EIR have occurred. The Board of Supervisors finds that the Permit Amendment does not present substantial changes in the project, substantial changes in the circumstances, or new information of substantial importance that would require major revisions to the adopted FEIR due to new significant environmental effects or substantial increase in the severity of previously identified significant environmental effects. .

- EVIDENCE:**
- a) The original CEQA action on the Use Permit for the California Flats Solar project was certification of an Environmental Impact Report (EIR.)Per CEQA Guidelines Section 15162, this permit amendment involves no substantial changes requiring subsequent environmental review, and there is no new information of substantial importance requiring revisions of the EIR (SCH#2013041031, certified by the Monterey County Board of Supervisors on February 10, 2015, Resolution No. 15-026). See EIR Addendum in **Attachment B** to the June 16, 2020 Staff Report to the Monterey County Board of Supervisors.
 - b) The Amendment modifies the Use Permit for the approved and constructed California Flats Solar Project to include the installation and operation of a Battery Energy Storage System and associated substation improvements and grading. Construction of the Battery Energy Storage System would take a total of approximately four (4) to seven (7) months. The proposed modification is located entirely within the existing 2,120-acre Solar Development Area, as approved in the original California Flats Solar Project. The actual footprint of the California Flats Solar Project is considerably less at 1,684 acres of the 2,120-acre Solar Development Area, approximately 436 acres less

than originally anticipated. The Use Permit allowed 880,000 cubic yards cut and 880,000 cubic yards of fill. The total grading, inclusive of the proposed grading for the Amendment, is 893,880 cubic yards of cut and 540,299 cubic yards of fill. Grading (cut) is 1.5% over the 880,000 cubic yards analyzed in the EIR and approved in the Use Permit. This 1.5% overage is minor in nature and does not result in new significant environmental effects or substantial increase in the severity of previously identified environmental effects. All potential impacts were already assessed in the original permit action the current proposal does not alter the analysis or conclusions reached under the original permit.

- c) The permit amendment will carry forward all applicable mitigation measures from the original entitlement (PLN120294).
- d) The application, plans, and supporting materials submitted by the project applicant to Monterey County RMA-Planning for the original project and the proposed amendment found in Project File Nos. PLN120294 and PLN120294-AMD1.

NOW, THEREFORE, BE IT FURTHER RESOLVED, based on all of the above findings and evidence and the administrative record as a whole, that the Board of Supervisors does hereby:

- a. Certify that it has considered an Addendum together with the previously certified California Flats Solar Project Environmental Impact Report (SCH #2013041031) pursuant to Section 15164 of the CEQA Guidelines;
- b. Approve an Amendment to the Use Permit for the California Flats Solar Project (approved on February 10, 2015, Resolution No. 15-027)) to construct up an to 85 unit Tesla Megapack battery energy storage system and associated infrastructure improvements, including approximately 7,243 cubic yards of cut and 1,489 cubic yards of fill, with remaining soil to be balanced or stockpiled onsite. The proposed modification is located entirely within the existing footprint of the California Flats Project, encompassing an area of approximately 3 acres specifically on Assessor's Parcel Numbers 424-181-014 and 424-181-015 and within the "solar development area" footprint, subject to the conditions of approval and in general conformance with the plans, attached hereto and incorporated herein by reference; and
- c. Adopt a Condition Compliance and Mitigation Monitoring and Reporting Program to reflect the new/amended conditions.

This project substantially conforms with the original permit for the California Flats Project and is subject to several mitigation measures of the original project. A resolution, including findings and evidence and eight (8) new conditions, including a condition detailing the mitigation measures from the original permit applicable to the amendment, is attached for consideration

PASSED AND ADOPTED on this 16th day of June 2020, by roll call vote:

AYES: Supervisors Alejo, Phillips, Lopez, Parker and Adams

NOES: None

ABSENT: None

(Government Code 54953)

I, Valerie Ralph, Clerk of the Board of Supervisors of the County of Monterey, State of California, hereby certify that the foregoing is a true copy of an original order of said Board of Supervisors duly made and entered in the minutes thereof of Minute Book 82 for the meeting June 16, 2020.

Dated: June 16, 2020
File ID: RES 20-087
Agenda Item No.: 14

Valerie Ralph, Clerk of the Board of Supervisors
County of Monterey, State of California



Joel G. Pablo, Deputy

NOTATION ON REVISED ISSUANCE OF BOARD ORDER, RESOLUTION AND EXHIBITS

REVISED EXHIBIT 1

* Clerical Correction to correct "property owner" with applicant" throughout Condition 5

**1st REVISION DATED DECEMBER 14, 2020 AND NOTED BY JOEL G. PABLO, DEPUTY BOARD CLERK UNDER
DIRECTION/GUIDANCE OF MELISSA MCDOUGAL, ADMINISTRATIVE SECRETARY OF THE HOUSING AND
COMMUNITY DEVELOPMENT DEPARTMENT**

Exhibit 1

This page intentionally left blank.

Monterey County RMA Planning

Conditions of Approval/Implementation Plan/Mitigation Monitoring and Reporting Plan

PLN120294-AMD1

1. PD001 - SPECIFIC USES ONLY

Responsible Department: RMA-Planning

Condition/Mitigation Monitoring Measure: This Amendment (PLN120294-AMD1) to the California Flats Use Permit (approved pursuant to Board of Supervisors Resolution No. 15-027 / PLN120294) allows the construction of up to 85 Tesla Megapack battery storage system and associated infrastructure improvements, including approximately 7,243 cubic yards of cut and 1,489 cubic yards of fill, with remaining 5,754 cubic yards of fill material to be stocked piled onsite. The modification is to be located entirely within the existing footprint of the California Flats Project, encompassing an area of approximately 3 acres specifically on APNs 424-181-014-000 and 424-181-015-000. The property is located at the Southeasterly corner of Monterey County, approximately 7 miles Southwest of Parkfield and 25 miles Northeast of Paso Robles, East of Turkey Flats Road and North of State Highway 46 near borders of Monterey, San Luis Obispo, Kings, and Fresno Counties (Assessor's Parcel Number 424-181-014-000 and 424-181-015-000), South County Area Plan. This permit was approved in accordance with County ordinances and land use regulations subject to the terms and conditions described in the project file. Neither the uses nor the construction allowed by this permit shall commence unless and until all of the conditions of this permit are met to the satisfaction of the Director of RMA - Planning. Any use or construction not in substantial conformance with the terms and conditions of this permit is a violation of County regulations and may result in modification or revocation of this permit and subsequent legal action. No use or construction other than that specified by this permit is allowed unless additional permits are approved by the appropriate authorities. To the extent that the County has delegated any condition compliance or mitigation monitoring to the Monterey County Water Resources Agency, the Water Resources Agency shall provide all information requested by the County and the County shall bear ultimate responsibility to ensure that conditions and mitigation measures are properly fulfilled. (RMA - Planning)

NOTE: THIS PERMIT AMENDMENT IS ALSO SUBJECT TO SEVERAL MITIGATION MEASURES OF THE ORIGINAL USE PERMIT (PLN120294; BOARD RESOLUTION NOS 15-026 AND 15-027), WHICH REMAIN IN FULL EFFECT. See Condition No. 2-PDSP000.

Compliance or Monitoring Action to be Performed: The Owner/Applicant shall adhere to conditions and uses specified in the permit on an on-going basis unless otherwise stated.

2. PDSP000- MITIGATION MEASURES APPLICABLE TO THIS AMENDMENT

Responsible Department: RMA-Planning

Condition/Mitigation Monitoring Measure: The following mitigation measures pursuant to BOS Resolution Nos. 15-026 and 15-027 (PLN120294, February 10, 2015), apply to this Permit Amendment:

AESTHETICS- MM #2 - AES-3 Minimize Construction Lighting

AIR QUALITY- MM #3 - AQ-2(A) Dust Control Measures; MM #4 - AQ(B) Emission-Reduction Measures For Construction Equipment; MM #5 - AQ-2(C) Tier 3 Construction Equipment; MM #6 - AQ-6(A) Valley Fever Management Plan; MM #7 - AQ-6(B) Additional Valley Fever Dust Suppression Measures; MM #8 - Monterey County Health Department Notification; MM #9 - AQ-6(D) Valley Fever Worker Training Program And Safety Measures; MM #10 - AQ-6(E) Valley Fever Information Handout; MM #11 - AQ-9 Construction Management Plan Requirements

BIOLOGICAL RESOURCES- MM #12 - B-1(A) Nested Compensatory Mitigation; MM #15 - B-1(D) Special Status Plant Species Avoidance And Minimization; MM #16 - B-1(E) Compensatory Mitigation For Special Status Plant Species; MM #17 - B-1(F) Preconstruction Survey For American Badger; MM #18 - B-1(G) American Badger Avoidance And Minimization; MM #19 - B-1(H) Preconstruction Surveys For San Joaquin Kit Fox; MM #20 - B-1(I) San Joaquin Kit Fox Den Avoidance And Minimization Measures; MM #21 - B-1(J) Compensatory Habitat Mitigation For San Joaquin Kit Fox; MM #22 - B-1(K) Remove Wild Animals And Livestock Carcasses; MM #23 - B-1(L) Preconstruction Surveys For Burrowing Owl; MM #24 - B-1(M) Burrowing Owl Avoidance And Minimization Measures; MM #25 - B-1(N) Compensatory Habitat Mitigation For Burrowing Owl; MM #26 - B-1(O) Preconstruction Surveys For Coachwhip And Coast Horned Lizard; MM #28 - B-1(Q) Bat Preconstruction Surveys And Avoidance; MM #29 - B-1(R) Preconstruction Survey For Raptors And Other Special Status Bird; MM #30 - B-1(S) Special Status Bird Species Impact Avoidance And Minimization; MM #42 - B-1(ee) Construction Biological Monitoring; MM #43 - B-1(ff) Special Status Animal Species General Avoidance Meas. And Const. Bmps; MM #44 - B-1(gg) Worker Environmental Awareness Program; MM #45 - B-2(a) Valley Needlegrass Grassland And Wildflower Field Habitat Mitigation; MM #46 - B-2(b) Habitat Restoration And Revegetation Plan; MM #47 - B-2(c) Project Vegetation And Invasive Species Management Plan; MM #49 - B-2(e) Riparian/Stream Habitat Setbacks; MM #50 - B-2(f) Stream Channel Avoidance And Minimization; MM #51 - B-2(g) Directional Boring Avoidance And Minimization; MM #52 - B-2(h) Show Streams And Riparian Habitat, And Associated Setbacks, On Const. Dwgs; MM #53 - B-2(i) Riparian/Stream Mitigation; MM #54 - B-3(a) Wetland Avoidance And Minimization; MM #57 - B-3(d) Wetland Habitat Mitigation; MM #58 - B-4(a) Pronghorn Calving Ground Avoidance And Minimization

CULTURAL & PALEONTOLOGICAL RESOURCES- MM #62 - CR-1(a) Archaeological Site Avoidance; MM #63 - CR-1(b) Site Capping And Data Indexing; MM #64 - CR-1(c) Data Recovery Excavation; MM #65 - CR-1(d) Archaeological Resource WEAP; MM #66 - CR-1(e) Archaeological Resource Construction Monitoring; MM #67 - CR-1(f) Native American Construction Monitoring; MM #68 - CR-2 Previously Unidentified Archaeological Resources; MM #69 - CR-4(a) Paleontological Resource Mitigation Plan; MM #70 - CR-4(b) Paleontological Resource Construction Monitoring

HAZARDS & HAZARDOUS MATERIALS- MM #72 - HAZ-3 Locate Underground Utilities; MM #73 - HAZ-4(a) Final Fuel Management Plan; MM #74 - HAZ-4(b) Emergency Access

HYDROLOGY AND WATER QUALITY- HYD-2(a) Accidental Spill Control And Environmental Training; MM #77 - HYD-2(b) Maintain Vehicles And Equipment

PUBLIC SERVICES- MM #78 - PS-1(a) Construction Management Plan; MM #79 -

PS-1(b) Emergency Response Training; MM #80 - PS-1(C) Fire Protection During Construction
TRANSPORTATION/TRAFFIC- MM #81 - T-2 Friday Peak Hour Control Measures – Construction Phase
LONG-TERM IMPACTS - MM #84 - LT-1 Worker Housing Program

Compliance or Monitoring Action to be Performed: The list of Mitigation Measures above apply to this Permit Amendment (PLN120294-AMD1) and shall be adhered to.

3. PD002 - NOTICE PERMIT APPROVAL

Responsible Department: RMA-Planning

Condition/Mitigation Monitoring Measure: The owner/applicant shall record a Permit Approval Notice. This notice shall state:
"A Permit Amendment (Resolution Number_) was approved by Monterey County Board of Supervisors for Assessor's Parcel Numbers 424-181-014-000 and 424-181-015-000 on June 16, 2020. The permit was granted subject to 8 conditions of approval which run with the land. A copy of the permit is on file with Monterey County RMA - Planning.

NOTE: THIS PERMIT AMENDMENT IS ALSO SUBJECT TO SEVERAL MITIGATION MEASURES OF THE ORIGINAL USE PERMIT (PLN120294; BOARD RESOLUTION NOS 15-026 AND 15-027), WHICH REMAIN IN FULL EFFECT AND ARE LISTED IN THE PERMIT AMENDMENT RESOLUTION, UNDER CONDITION NO. 2"

Proof of recordation of this notice shall be furnished to the Director of RMA - Planning prior to issuance of grading and building permits, Certificates of Compliance, or commencement of use, whichever occurs first and as applicable. (RMA - Planning)

Compliance or Monitoring Action to be Performed: Prior to the issuance of grading and building permits, certificates of compliance, or commencement of use, whichever occurs first and as applicable, the Owner/Applicant shall provide proof of recordation of this notice to the RMA - Planning.

4. PD006 - CONDITION OF APPROVAL / MITIGATION MONITORING PLAN

Responsible Department: RMA-Planning

Condition/Mitigation Monitoring Measure: The applicant shall enter into an agreement with the County to implement a Condition of Approval/Mitigation Monitoring and/or Reporting Plan (Agreement) in accordance with Section 21081.6 of the California Public Resources Code and Section 15097 of Title 14, Chapter 3 of the California Code of Regulations. Compliance with the fee schedule adopted by the Board of Supervisors for mitigation monitoring shall be required and payment made to the County of Monterey at the time the property owner submits the signed Agreement. The agreement shall be recorded. (RMA - Planning)

NOTE: A revised MMRP is required in order to incorporate new conditions of approval of this permit (PLN120294-AMD1) and transfer certain mitigation measures of original permit (PLN120294) to this Amendment. See Condition 2 for List of transferred mitigation measures.

Compliance or Monitoring Action to be Performed: Within sixty (60) days after project approval or prior to the issuance of building and grading permits, whichever occurs first, the Owner/Applicant shall:

- 1) Enter into an agreement with the County to implement a Condition of Approval/Mitigation Monitoring Plan.
- 2) Fees shall be submitted at the time the property owner submits the signed Agreement.
- 3) Proof of recordation of the Agreement shall be submitted to RMA-Planning.

5. CC01 INDEMNIFICATION AGREEMENT

Responsible Department: County Counsel-Risk Management

Condition/Mitigation Monitoring Measure: The Applicant agrees as a condition and in consideration of approval of this discretionary development permit that it will, pursuant to agreement and/or statutory provisions as applicable, including but not limited to Government Code Section 66474.9, defend, indemnify and hold harmless the County of Monterey or its agents, officers and employees from any claim, action or proceeding against the County or its agents, officers or employees to attack, set aside, void or annul this approval, which action is brought within the time period provided for under law, including but not limited to, Government Code Section 66499.37, as applicable. The Applicant will reimburse the County for any court costs and attorney's fees which the County may be required by a court to pay as a result of such action. The County may, at its sole discretion, participate in the defense of such action; but such participation shall not relieve applicant of his/her/its obligations under this condition. An agreement to this effect shall be recorded upon demand of County Counsel or concurrent with the issuance of building permits, use of property, filing of the final map, recordation of the certificates of compliance whichever occurs first and as applicable. The County shall promptly notify the Applicant of any such claim, action or proceeding and the County shall cooperate fully in the defense thereof. If the County fails to promptly notify the Applicant of any such claim, action or proceeding or fails to cooperate fully in the defense thereof, the Applicant shall not thereafter be responsible to defend, indemnify or hold the County harmless. (County Counsel-Risk Management)

Compliance or Monitoring Action to be Performed: Upon demand of County Counsel or concurrent with the issuance of building permits, use of the property, recording of the final/parcel map, or recordation of Certificates of Compliance, whichever occurs first and as applicable, the Owner/Applicant shall submit a signed and notarized Indemnification Agreement to the Office of County Counsel-Risk Management for review and signature by the County.

Proof of recordation of the Indemnification Agreement, as outlined, shall be submitted to the Office of County Counsel-Risk Management

6. PDSP001- GOOD NEIGHBOR SCREENING

Responsible Department: RMA-Planning

Condition/Mitigation Monitoring Measure: Prior to the issuance of a construction permit (including grading permit), the owner/applicant shall submit a screening plan to RMA-Planning for review and approval. The screening plan shall include landscape screening treatments inclusive of mature trees and fencing with privacy slats along the northern and western boundaries of the Battery Energy Storage System (BESS) modification. All screening shall be installed prior to final inspection of construction permit (including grading permit).

Compliance or Monitoring Action to be Performed: Prior to the issuance of a construction permit (including grading permit), the applicant shall submit a screening plan to RMA-Planning for review and approval.

Prior to final inspection of a construction permit (including grading permit), the applicant shall install approved screening treatment.

On an ongoing basis, screening treatment shall be continuously maintained in a litter-free, weed-free, healthy condition.

7. PDSP002- GRADING DISPOSITION TO BE STORED ONSITE

Responsible Department: RMA-Planning

Condition/Mitigation Monitoring Measure: Grading: The BESS project is anticipated to disturb an area of approximately 2.5 acres, requiring approximately 7,243 cubic yards of cut and 1,489 cubic yards of fill. No grading material is expected to be hauled off-site. The balance of material, approximately 5,754 cubic yards, will be temporarily stockpiled on-site for future reuse by the property owner (Hearst Corporation). The stockpiled material will be used as part of on-going ranch maintenance related activities. The final location for soil deposition will be determined based on discussions between Hearst and the Applicant. This condition of approval requires the grading material to be placed on-site and the grading permit shall demonstrate this.

Compliance or Monitoring Action to be Performed: Submit grading plans for review and approval to RMA demonstrating no grading material shall be exported off-site.

8. CALIFORNIA CONSTRUCTION GENERAL PERMIT

Responsible Department: Environmental Services

Condition/Mitigation Monitoring Measure: The applicant shall submit a Stormwater Pollution Prevention Plan (SWPPP) including the Waste Discharger Identification (WDID) number, to RMA-Environmental Services. In lieu of a SWPPP, a letter of exemption or erosivity waiver from the Central Coast Regional Water Quality Control Board may be provided. (RMA-Environmental Services)

Compliance or Monitoring Action to be Performed: Prior to issuance of any grading or building permits, the applicant shall submit a SWPPP including the WDID number certifying the project is covered under the California Construction General Permit or a letter of exemption from the Central Coast Regional Water Quality Control Board.

Exhibit 2

This page intentionally left blank.

DRAWINGS:
 CA FLATS-GP-001
 CA FLATS-GP-002
 CA FLATS-GP-003
 CA FLATS-GP-004
 CA FLATS-GP-005
 CA FLATS-GP-006

TITLE:
 COVER
 NOTES
 SITE PLAN
 SUB 60 GRADING & DRAINAGE PLAN
 BESS SITE GRADING & DRAINAGE PLAN
 DETAILS

PROJECT LOCATION

SUB 60:
 N 1839139.03
 E 6170314.61
 BESS SITE:
 N 1839442.60
 E 6169016.78

CONTACTS

ENGINEERING MANAGER:
 KEVIN MATHEY, PE
 BURNS & McDONNELL ENGINEERING CO., INC.
 4225 EXECUTIVE SQUARE, SUITE 500
 LA JOLLA, CA 92037
 PHONE: 858-260-5883
 KMATHEY@BURNSMCD.COM

DRAFTER:

DANNIEL SANCHEZ
 BURNS & McDONNELL ENGINEERING CO., INC.
 140 S. ST COLLEGE BLVD, SUITE 100
 BREA, CA 92821
 PHONE: 714-989-2092
 DJSANCHEZ@BURNSMCD.COM

FLOOD INSURANCE RATE MAP (FIRM)

FEMA # 06053C2025G
 Flood Zone X

REFERENCES (SURVEY)

CA FLATS BATTERY STORAGE SITE
 PREPARED BY GSI SURVEYORS

BASIS OF BEARING:

CALIFORNIA COORDINATE SYSTEM CCS83 (2011)
 EPOCH 2010.00 ZONE 4

NORTHING, EASTING COORDINATES:

CCS83, ZONE 4 GRID

BENCH MARK:

LOCATED AT POINT NO. 2000 ESTABLISHED BY USING STATIC,
 GPS ELEVATION = 1650.46 US FT.

GEOTECHNICAL INVESTIGATION REPORT:

SEE THE GEOTECHNICAL INVESTIGATION REPORT TITLE 'TBD'
 PREPARED BY TRINITY ENGINEERS



GRADING and DRAINAGE PLANS FOR CA FLATS 60 MW SUBSTATION and BESS SITE MONTEREY COUNTY, CALIFORNIA

FEBRUARY 2020

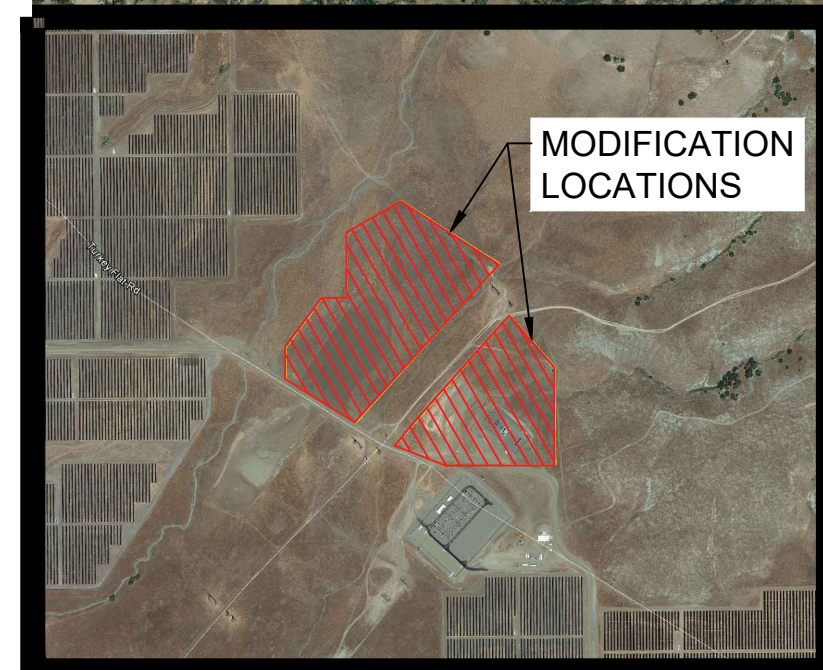
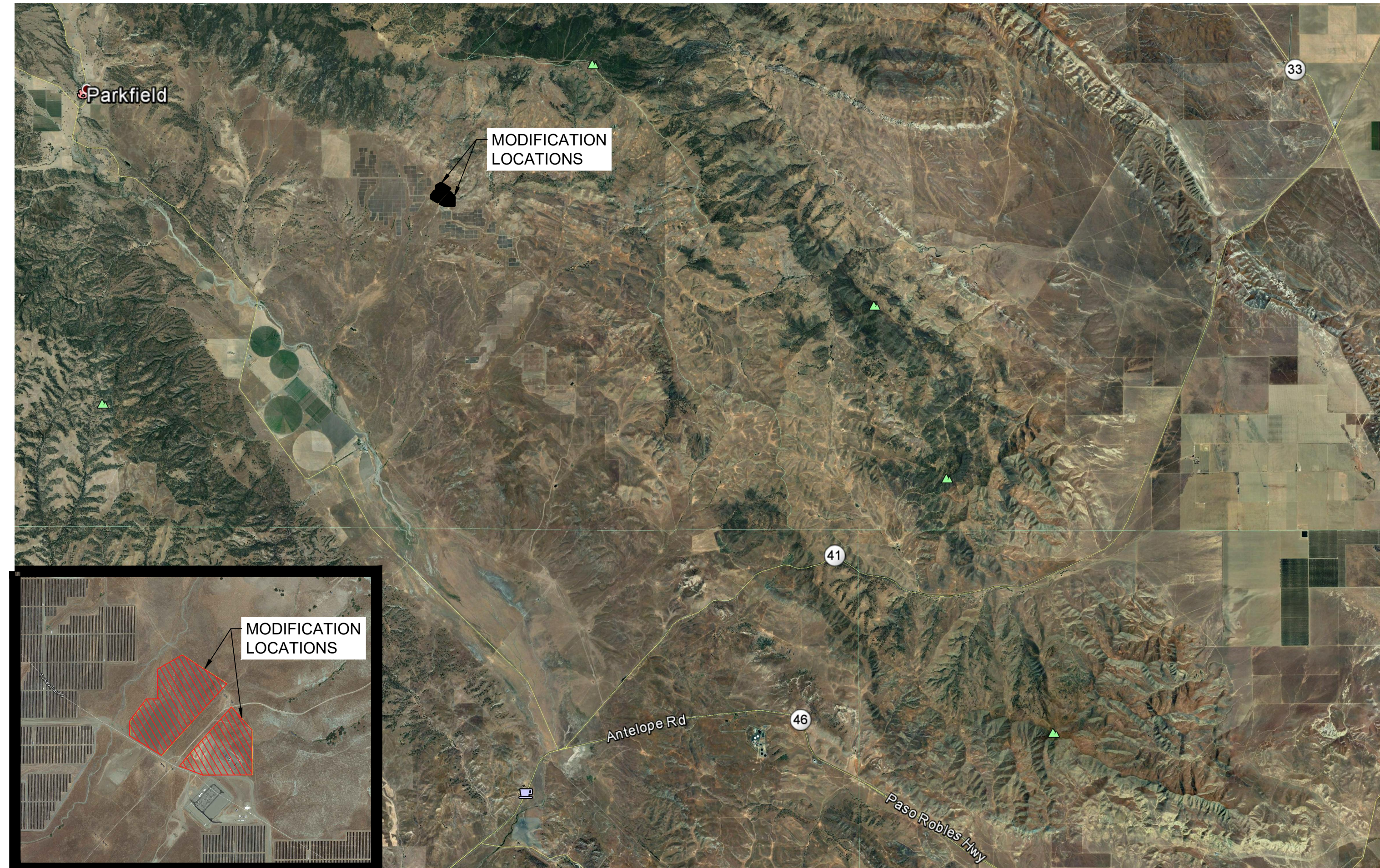

PROPOSED SITE DEVELOPMENT
 NTS

LOCATION MAP 1
 NTS

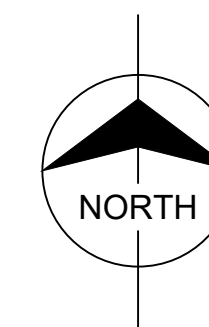

no.	date	by	ckd	description
2-11-20				ISSUED FOR REVIEW

NOT FOR CONSTRUCTION

4225 EXECUTIVE SQUARE, SUITE 500
 LA JOLLA, CA

date 2/10/2020	detailed D. SANCHEZ
designed K. MATHEY	checked -

MONTEREY COUNTY, CA

CA FLATS
 SUBSTATION 60 and BESS SITE LAYOUT
 COVER SHEET

project	contract
drawing	rev.0
CA FLATS-GP-001	
sheet 1	of 6 sheets
file CA FLATS-GP-001.dwg	

Millimeters
 Scale For Microfilming
 Inches

COPYRIGHT © 2019 BURNS & McDONNELL ENGINEERING COMPANY, INC.

CONSTRUCTION NOTES:

1. CONTRACTOR SHALL CONFORM TO PERTINENT LOCAL, STATE, AND FEDERAL CODES, REQUIREMENTS, AND STANDARDS.
2. ALL PRODUCTS SHALL BE INSTALLED IN ACCORDANCE WITH THE MANUFACTURER'S OR SUPPLIER'S INSTRUCTIONS OR RECOMMENDATIONS.
3. CONTRACTOR SHALL BE RESPONSIBLE FOR THE SAFE AND HEALTHFUL PERFORMANCE OF WORK BY EACH OF ITS EMPLOYEES, SUBCONTRACTORS, VENDORS OR SUPPORT PERSONNEL ENTERING THE PROJECT AREA.
4. ANY INSPECTION BY OWNER OR ENGINEER SHALL NOT IN ANY WAY RELIEVE CONTRACTOR FROM FULL CONFORMANCE WITH APPLICABLE CODES AND JURISDICTIONAL REQUIREMENTS.
5. CONTRACTOR SHALL BE RESPONSIBLE FOR CONSTRUCTION MEANS, METHODS, AND SEQUENCES, AND TO CARRY OUT WORK IN ACCORDANCE WITH CONTRACT DOCUMENTS.
6. CONTRACTOR SHALL BE RESPONSIBLE FOR COSTS AND REPAIRS OF FAULTY CONSTRUCTION AND DAMAGES TO EXISTING FACILITIES NOT INTENDED TO BE DAMAGED OR DEMOLISHED, WHICH ARE CAUSED BY CONTRACTOR, HIS SUBCONTRACTORS, VENDORS AND SUPPORT PERSONNEL. THIS RESPONSIBILITY APPLIES TO FACILITIES WHETHER OR NOT SHOWN ON THESE DRAWINGS.
7. CONTRACTOR SHALL SATISFY HIMSELF AS TO THE ACTUAL FIELD CONDITIONS PRIOR TO BID AND PRIOR TO WORK. NO CLAIM SHALL BE MADE AGAINST ENGINEER FOR DISCREPANCIES BETWEEN CONDITIONS REPRESENTED ON THESE DRAWINGS AND ACTUAL.
8. NO CONSTRUCTION ACTIVITIES SHALL TAKE PLACE OUTSIDE OF THE PROJECT BOUNDARIES. THE PROJECT BOUNDARIES MEANS AREAS WHERE OWNER HAS RIGHTS TO CONSTRUCT THE PROJECT. CONTRACTOR SHALL NOT ACCESS THE SITE OUTSIDE OF LEGAL RIGHT-OF-WAY ACCESS. CONTRACTOR SHALL BE RESPONSIBLE FOR ANY TEMPORARY CONSTRUCTION EASEMENTS, AS NECESSARY, FOLLOWING LOCAL REQUIREMENTS.
9. UNDERGROUND UTILITY INFORMATION IS BASED ON LIMITED DATA. THERE MAY BE EXISTING UTILITIES WHICH ARE NOT SHOWN ON THESE DRAWINGS.
10. CONTRACTOR SHALL BE RESPONSIBLE TO CONTACT CALIFORNIA 811 THREE (3) WORKING DAYS BEFORE DIGGING.
11. IN THE EVENT THAT HISTORIC OR PREHISTORIC SURFACE OR SUBSURFACE OBJECTS ARE ENCOUNTERED DURING THE PROJECT ACTIVITIES, CONTRACTOR MUST DISCONTINUE WORK IN THE IMMEDIATE AREA, AND AN ARCHAEOLOGIST MUST BE CONSULTED TO EVALUATE THE NATURE AND SIGNIFICANCE OF THE MATERIAL.
12. SOIL SHALL BE WETTED AS APPROPRIATE FOR DUST CONTROL. CONTRACTOR SHALL BE RESPONSIBLE TO COMPLY WITH JURISDICTIONAL AIR QUALITY REQUIREMENTS.
13. CONTRACTOR SHALL BE RESPONSIBLE FOR DUST CONTROL, EROSION CONTROL, BEST MANAGEMENT PRACTICES, AND DRAINAGE DURING CONSTRUCTION, IN COMPLIANCE WITH JURISDICTIONAL STANDARDS, AND SUBJECT TO ENGINEER'S APPROVAL.
14. CONTRACTOR SHALL KEEP SITE ACCESSES CLEAN AT ALL TIMES.
15. FINAL STABILIZATION OF GROUND SURFACES AT PROJECT COMPLETION SHALL MEET JURISDICTIONAL STANDARDS, AND SHALL BE SUBJECT TO ENGINEER'S APPROVAL.
16. CONTRACTOR SHALL BE RESPONSIBLE FOR THE PREPARATION, UPDATES, AND MAINTENANCE OF A STORM WATER POLLUTION PREVENTION PLAN (SWPPP), IN CONFORMANCE WITH CALIFORNIA REQUIREMENTS.
17. CONTRACTOR SHALL BE RESPONSIBLE FOR PERFORMING/PROVIDING BEST MANAGEMENT PRACTICES (BMP) TO MINIMIZE POLLUTANTS IN STORMWATER RUNOFF TO THE GREATEST EXTENT PRACTICAL. CONTRACTOR SHALL REMOVE THE BMP'S INTENDED TO BE REMOVED AT PROJECT COMPLETION.
18. CONTRACTOR SHALL BE RESPONSIBLE FOR TRAFFIC CONTROL AS NECESSARY.
19. EXISTING FENCING AND CATTLE GUARDS MUST BE MAINTAINED TO ASSURE CONTAINMENT OF GRAZING OPERATIONS. ANY REPAIRS SHALL MATCH EXISTING IN KIND.
20. CONTRACTOR SHALL COORDINATE WITH AND OBTAIN APPROVALS FROM ENGINEER PRIOR TO ANY DESIGN CHANGES, SIGNIFICANT ADJUSTMENTS OR VARIATIONS FROM THE DRAWINGS.
21. FINISHED GRADING AND PAVING SHALL SURFACE/GRAVITY DRAIN AWAY FROM FOUNDATIONS/FACILITIES, AND SHALL NOT "POND" OR RETAIN RAIN WATER.
22. CONTRACTOR SHALL KEEP PROJECT AREA NEAT, CLEAN, AND ORDERLY DURING CONSTRUCTION, AND SHALL MAKE THE PROJECT AREA NEAT AND CLEAN AT PROJECT COMPLETION.
23. UNLESS NOTED OTHERWISE, PROPOSED ELEVATIONS AND CONTOURS SHOWN ARE TO TOP OF FINISHED GRADE. CONTRACTOR SHALL GRADE TO SUBGRADE AND GRADE TO DRAIN, PROOF ROLL WITH LOADED DUMP TRUCK OR APPROVED EQUIPMENT AND THEN HYDROMULCH FOR SITE STABILIZATION.
24. GRADE SHALL SLOPE UNIFORMLY, AT CONSTANT SLOPE, BETWEEN THE DESIGN SPOT ELEVATIONS SHOWN ON THESE DRAWINGS.

CONSTRUCTION NOTES (CONTINUED):

25. WORK WHICH DOES NOT MEET THE HORIZONTAL LOCATIONS, LINES, SLOPES, AND ELEVATIONS WITHIN SPECIFIED OR REASONABLE TOLERANCES, AS SHOWN ON THESE DRAWINGS, SHALL BE SUBJECT TO REPLACEMENT AT CONTRACTOR'S EXPENSE.
- SITE PREPARATION**
1. INSTALL ALL NECESSARY EROSION CONTROL DEVICES AND TEMPORARY DRAINAGE DITCHES AS NECESSARY TO KEEP THE SITE FREE FROM EROSION AND PONDING WATER AT ALL TIMES.
 2. CLEAR AND GRUB THE NEW CONSTRUCTION AREAS TO THE CUT/FILL DAYLIGHT LINE AS GIVEN ON THE DRAWINGS AND SPECIFICATIONS. ALL VEGETATION, TREES, BRUSH, GRASS AND OTHER OBJECTIONABLE MATERIALS SHALL BE REMOVED, COLLECTED AND DISPOSED OF BY SUBCONTRACTOR. WHEN TREES ARE REMOVED IN AREAS OF PERMANENT DISTURBANCE, THE ROOT SYSTEMS SHALL ALSO BE REMOVED. ALL AREAS THAT ARE CLEARED SHALL BE LEFT WITH A NEAT AND FINISHED APPEARANCE AND FREE FROM UNSIGHTLY DEBRIS.
 3. NO VEGETATION OR CONSTRUCTION DEBRIS SHALL BE BURIED ONSITE AND NO BURNING PITS WILL BE PLACED ON SITE.
 4. TREES OUTSIDE OF THE AREAS TO BE GRADED OR OTHER AREAS TO BE IMPROVED SHALL BE PROTECTED FROM DAMAGE BY THE SUBCONTRACTOR'S OPERATIONS.
 5. INSTALL ALL REQUIRED EROSION CONTROL DEVICES.
- GRADING**
1. IT SHALL BE THE SUBCONTRACTOR'S RESPONSIBILITY TO PERFORM ALL GRADING AND EARTHWORK IN STRICT ACCORDANCE WITH PROJECT SPECIFICATIONS, PROJECT GEOTECHNICAL INVESTIGATION REPORT AND THESE DRAWINGS. IN CASE OF DISCREPANCY, THE MORE STRINGENT REQUIREMENT SHALL BE MET UNLESS NOTED OTHERWISE.
 2. A GEOTECHNICAL ENGINEER WILL BE THE CONTRACTOR'S REPRESENTATIVE TO INSPECT ALL EARTHWORK OPERATIONS. THE EXCAVATION AND PLACEMENT OF FILL SHALL BE UNDER THE DIRECT OBSERVATION AND INSPECTION OF THE GEOTECHNICAL ENGINEER. NO FILL SHALL BE PLACED UNTIL THE GEOTECHNICAL ENGINEER HAS APPROVED THE SUBGRADE.
 3. OBSERVATIONS AND COMPACTION TESTS WILL BE MADE BY THE GEOTECHNICAL ENGINEER DURING ALL EARTHWORK OPERATIONS TO ENSURE THE WORK WAS CONSTRUCTED IN ACCORDANCE WITH PROJECT SPECIFICATIONS AND DRAWINGS. THE GEOTECHNICAL ENGINEER WILL GIVE WRITTEN NOTICE OF CONFORMANCE WITH THE SPECIFICATIONS UPON COMPLETION OF GRADING.
 4. THE SITE CONSTRUCTION AREAS SHALL BE EXCAVATED, FILLED AND COMPACTED AS SHOWN ON THE DRAWINGS AND SPECIFICATIONS. ADDITIONAL OVER EXCAVATION MAY BE REQUIRED IN ISOLATED AREAS AND SHALL BE AS DIRECTED BY THE GEOTECHNICAL ENGINEER.
 5. THE PLACEMENT AND COMPACTION OF FILL MATERIALS SHALL BE IN ACCORDANCE WITH THE PROJECT SPECIFICATIONS AND THE DIRECTION OF THE GEOTECHNICAL INVESTIGATION REPORT.
 6. ALL SLOPES SHALL BE 2:1 HORIZONTAL TO VERTICAL UNLESS OTHERWISE NOTED AND SHALL BE ROUNDED INTO THE EXISTING TERRAIN TO PRODUCE A CONTOURED TRANSITION FROM CUT OR FILL FACES TO NATURAL GROUND AND ABUTTING CUT OR FILL SURFACES.
 7. THE SLOPES OF EXCAVATIONS OR EMBANKMENTS SHALL BE SHAPED AND TRIMMED AS DIRECTED AND LEFT IN A NEAT AND ORDERLY CONDITION. ALL STONES, ROOTS, ORGANIC MATTER, AND OTHER WASTE MATERIALS EXPOSED ON AN EXCAVATION OR EMBANKMENT SLOPE SHALL BE REMOVED AND DISPOSED OF OFF SITE.
 8. ALL AREAS TO BE GRADED SHALL BE CLEARED AND GRUBBED WITHIN THE AREA TO BE GRADED ONLY.
 9. THE SUBCONTRACTOR SHALL CONTROL SURFACE WATER RUNOFF TO AVOID DAMAGE TO ADJOINING PROPERTIES OR TO FINISH WORK ON THE SITE. THE SUBCONTRACTOR SHALL TAKE REMEDIAL MEASURES TO PREVENT EROSION OF THE FRESHLY GRADED AREAS, AND UNTIL SUCH TIME AS PERMANENT DRAINAGE AND EROSION CONTROL MEASURES HAVE BEEN INSTALLED.
 10. GRADING SHALL BE DONE WITHIN A TOLERANCE OF (+/-)0.1' OF THE GRADES AND ELEVATIONS SHOWN ON THE DRAWINGS. IN NO WAY SHALL THE ABOVE TOLERANCE RELIEVE THE SUBCONTRACTOR OF THE RESPONSIBILITY OF PROVIDING A FINISH THAT WILL NOT COLLECT OR POND WATER.
 11. UPON COMPLETION OF THE GRADING OBSERVATIONS AND ACCEPTANCE BY THE GEOTECHNICAL ENGINEER AND THE INSPECTOR, NO FURTHER EXCAVATION OR FILLING WORK SHALL BE DONE.

EROSION CONTROL NOTES

1. TOPS OF ALL FILL SLOPES TO BE DIKED TO PREVENT WATER FROM FLOWING OVER THE CREST. ALL ROADS AND STRUCTURE PADS SHALL BE CONSTRUCTED TO PREVENT WATER FROM CAUSING EROSION.
2. ALL BMP WORK SHALL COMPLY WITH MONTEREY COUNTY BMP HANDBOOK.
3. REFER TO SHEET 3 FOR PLACEMENT OF EROSION CONTROL DEVICES.

GEOTECHNICAL ENGINEER CERTIFICATION

ALL GRADING SHALL BE DONE UNDER THE OBSERVATION OF A QUALIFIED GEOTECHNICAL ENGINEER AND ENGINEERING GEOLOGIST AND IN ACCORDANCE WITH THE RECOMMENDATIONS OUTLINED IN THE GEOTECHNICAL INVESTIGATION REPORT TITLED 'TBD' PREPARED BY TRINITY ENGINEERS.

WELL LOCATIONS

1. FJ WEST WELL: APPROXIMATELY 4.3 MILES SOUTHEAST OF PROPOSED BESS MODIFICATION
2. AGRICULTURAL WELL #2: APPROXIMATELY 3.6 MILES SOUTH/SOUTHWEST OF PROPOSED BESS MODIFICATION
3. O&M WELL: APPROXIMATELY 1500' WEST OF THE PROPOSED BESS MODIFICATION

LEGEND:

- RIGHT-OF-WAY LINE
- CENTERLINE - SURVEY
- CENTERLINE - PAVEMENT
- EXISTING CONTOUR
- PROPOSED CONTOUR
- EXISTING EDGE OF DIRT ROAD
- EXISTING BARBED WIRE FENCE
- PROPOSED CHAIN-LINK FENCE
- EXISTING GATE - BARBED WIRE
- PROPOSED GATE
- INDICATES EXISTING DRAINAGE FLOW DIRECTION/PATTERN
- PROPOSED 1'X4' ROCK LINED (4" NO. 57) DITCH
- 1% SLOPE
- HYDROMULCH
- FIBER ROLL
- EXISTING OVERHEAD ELECTRIC LINE

ABBREVIATIONS:

- ABC AGGREGATE BASE COURSE
- AC ACRES
- C RUNOFF COEFFICIENT
- COR CORNER
- CF CUBIC FEET
- DTL DETAIL
- DWG DRAWING
- E EAST; EASTING
- EG EXISTING GRADE
- EXIST EXISTING
- PG PROPOSED GRADE
- FL FLOWLINE
- FPS FEET PER SECOND
- FS FINISH SURFACE
- HWE HIGH WATER ELEVATION
- IN INCHES
- N NORTH; NORTHING
- PI POINT OF INTERSECTION
- R RADIUS
- RLS REGISTERED LAND SURVEYOR
- SEC SECTION
- SF SQUARE FEET
- V VOLUME
- W WEST
- W/ WITH

no.	date	by	ckd	description
2-11-20				ISSUED FOR REVIEW
4-8-20				ADDED WELL NOTES

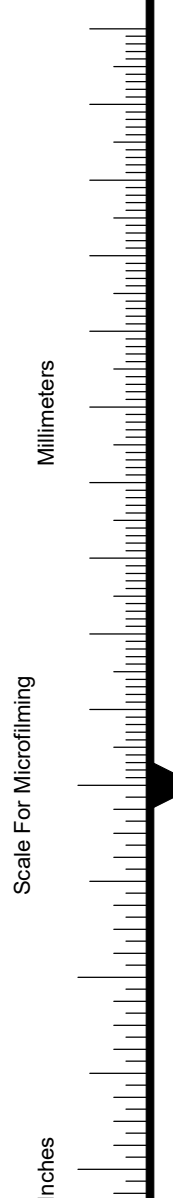

NOT FOR CONSTRUCTION

BURNS & MCDONNELL
 4225 EXECUTIVE SQUARE, SUITE 500
 LA JOLLA, CA

date	2/10/2020	detailed	D. SANCHEZ
designed	K. MATHEY	checked	-

CapitalDynamics

MONTEREY COUNTY, CA

CA FLATS
 SUBSTATION 60 AND BESS SITE LAYOUT
 NOTES

project	contract
drawing	rev. 0
CA FLATS-GP-002	
sheet 2 of 6 sheets	file CA FLATS-GP-002.dwg

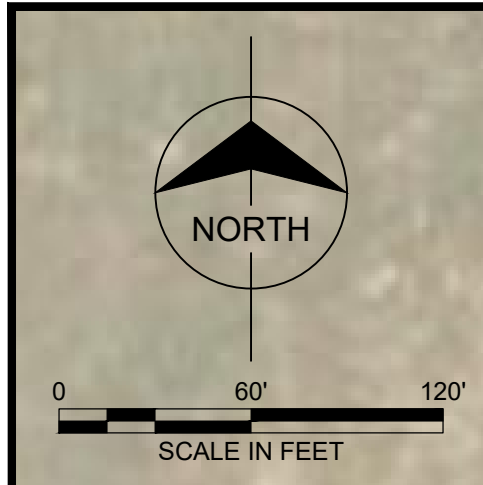
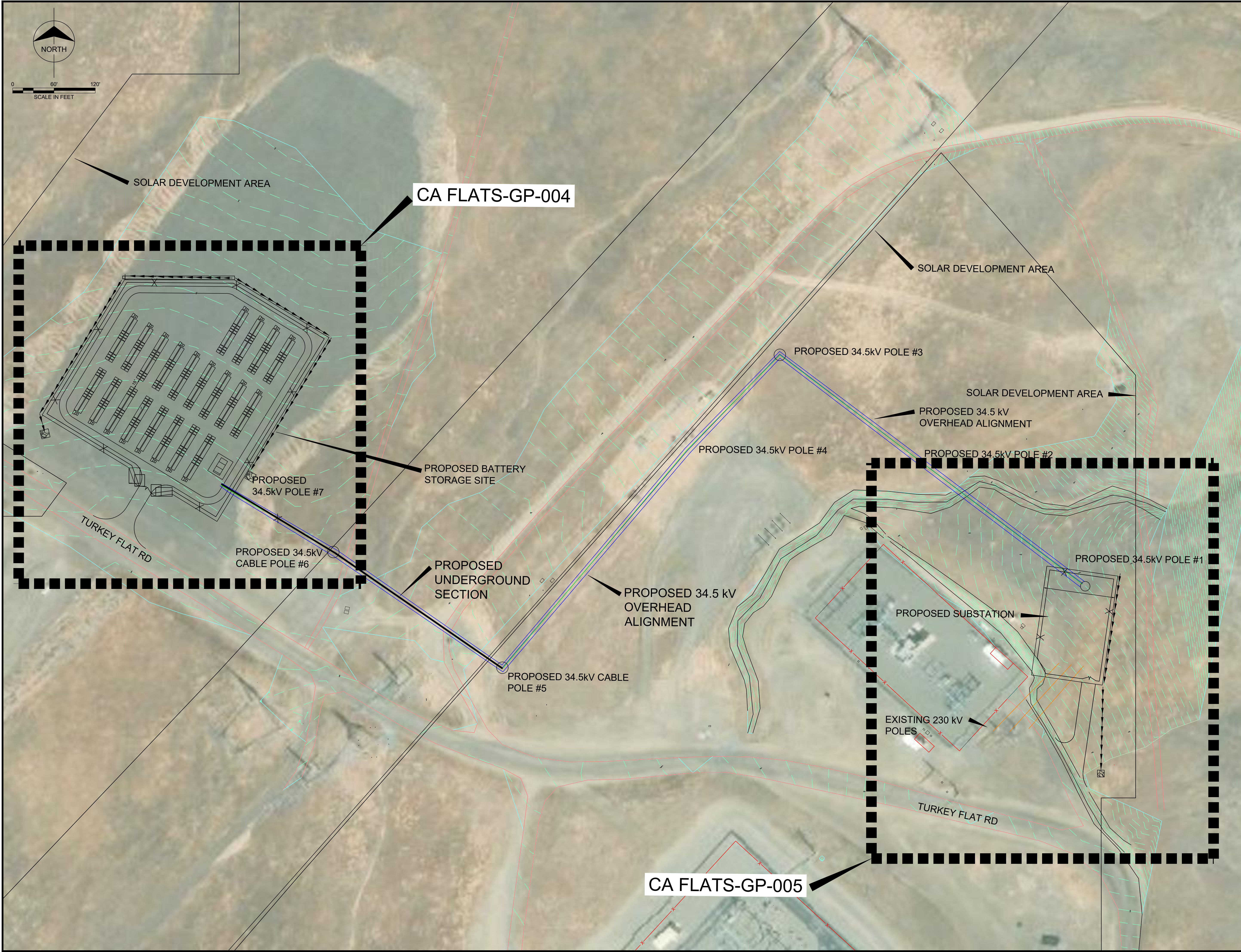

CA FLATS-GP-004

CA FLATS-GP-005

no.	date	by	ckd	description
-----	------	----	-----	-------------

no.	date	by	ckd	description



NOT FOR CONSTRUCTION



4225 EXECUTIVE SQUARE, SUITE 500
LA JOLLA, CA

date 2/10/2020	detailed D. SANCHEZ
designed K. MATHEY	checked -



MONTEREY COUNTY, CA

CA FLATS
SUBSTATION 60 AND BESS SITE LAYOUT
KEY PLAN

project	contract
---------	----------

drawing rev. 0
CA FLATS-GP-003

sheet 3 of 6 sheets
file CA FLATS-GP-003.dwg

COPYRIGHT © 2019 BURNS & MCDONNELL ENGINEERING COMPANY, INC.



- NOTES:**
1. FILL SLOPES SHALL BE 2:1.
 2. AFTER SUBGRADE PREPARATION IS COMPLETED, AND PRIOR TO PLACEMENT OF HYDROMULCH, NON-TOXIC VEGETATION ERADICATOR SHALL BE APPLIED TO THE TOPS OF BOTH PADS.
 3. CONTRACTOR SHALL MINIMIZE AREAS OF DISTURBANCE TO THE GREATEST EXTENT PRACTICAL TO PERFORM WORK. CONTRACTOR SHALL NOT DISTURB AREAS OUTSIDE OF THE 'CONSTRUCTION DISTURBANCE LIMITS' LINEWORK.
 4. FIBER ROLLS PER MONTEREY COUNTY CONSTRUCTION BMP HANDBOOK, JULY 2015 SHALL BE PLACED PER PLAN
 5. CONSTRUCTION ENTRANCE PER MONTEREY COUNTY CONSTRUCTION BMP HANDBOOK, JULY 2015 SHALL BE INSTALLED PRIOR TO START OF CONSTRUCTION ACTIVITIES.
 6. SEE SHEET 5 FOR DETAILS

- KEY NOTES:**
- 1 AREA TO BE HYDROMULCHED
 - 2 PROPOSED 20' GATE PER DETAILS ON SHEET GP-005.
 - 3 6' CHAIN LINK FENCE PER DETAIL# 1-001 ON SHEET GP-005.
 - 4 PROPOSED FIBER ROLL PER MONTEREY COUNTY CONSTRUCTION BMP HANDBOOK, JULY 2015.
 - 5 STABILIZED CONSTRUCTION ENTRANCE PER MONTEREY COUNTY CONSTRUCTION BMP HANDBOOK, JULY 2015.
 - 6 6" CRUSHED ROCK TO BE INSTALLED ON ENTIRE PAD.

QUANTITIES
 TOTAL DISTURBED AREA: 0.56 ACRES
 EARTHWORK: CUT 3,706 CY
 FILL 11 CY
 6' CHAIN LINK FENCE: 468 LF
 20' DOUBLE SWING GATE: 1 EACH
 1" CONCRETE DRAINAGE CHANNEL: 392 LF
 6" CRUSHED ROCK: 308 CY

no.	date	by	ckd	description
2-11-20				ISSUED FOR REVIEW



NOT FOR CONSTRUCTION



4225 EXECUTIVE SQUARE, SUITE 500
 LA JOLLA, CA

date 2/10/2020	detailed D. SANCHEZ
designed K. MATHEY	checked -



MONTEREY COUNTY, CA

CA FLATS
 SUBSTATION 60 AND BESS SITE LAYOUT
 PLAN VIEW

project	contract
drawing	rev. 0
CA FLATS-GP-004	
sheet 4	of 6 sheets
file CA FLATS-GP-004.dwg	

COPYRIGHT © 2019 BURNS & MCDONNELL ENGINEERING COMPANY, INC.

COPYRIGHT © 2019 BURNS & MCDONNELL ENGINEERING COMPANY, INC.



NOTES:

- CUT & FILL SLOPES SHALL BE 2:1.
- AFTER SUBGRADE PREPARATION IS COMPLETED, AND PRIOR TO PLACEMENT OF HYDROMULCH, NON-TOXIC VEGETATION ERADICATOR SHALL BE APPLIED TO THE TOPS OF BOTH PADS.
- CONTRACTOR SHALL MINIMIZE AREAS OF DISTURBANCE TO THE GREATEST EXTENT PRACTICAL TO PERFORM WORK. CONTRACTOR SHALL NOT DISTURB AREAS OUTSIDE OF THE 'CONSTRUCTION DISTURBANCE LIMITS' LINEWORK.
- FIBER ROLLS PER MONTEREY COUNTY CONSTRUCTION BMP HANDBOOK, JULY 2015 SHALL BE PLACED PER PLAN
- CONSTRUCTION ENTRANCE PER MONTEREY COUNTY CONSTRUCTION BMP HANDBOOK, JULY 2015 SHALL BE INSTALLED PRIOR TO START OF CONSTRUCTION ACTIVITIES.
- SEE SHEET 5 FOR DETAILS

KEY NOTES:

- AREA TO BE HYDROMULCHED
- PROPOSED GATE PER DETAILS ON SHEET GP-005.
- 6' CHAIN LINK FENCE PER DETAIL ON SHEET GP-005.
- PROPOSED FIBER ROLL PER MONTEREY COUNTY CONSTRUCTION BMP HANDBOOK, JULY 2015.
- STABILIZED CONSTRUCTION ENTRANCE PER MONTEREY COUNTY CONSTRUCTION BMP HANDBOOK, JULY 2015.
- 6" CRUSHED ROCK TO BE INSTALLED ON ENTIRE PAD.

QUANTITIES

TOTAL DISTURBED AREA: 2.06 ACRES

EARTHWORK: CUT 3537 CY
FILL 1478 CY

6' CHAIN LINK FENCE: 1046 LF

20' DOUBLE SWING GATE: 1 EACH

1'X4' ROCK LINED (4" NO.57) DRAINAGE CHANNEL: 832 LF

6" CRUSHED ROCK: 1439 CY

no.	date	by	ckd	description
	2-11-20			ISSUED FOR REVIEW

NOT FOR CONSTRUCTION

BURNS & MCDONNELL

4225 EXECUTIVE SQUARE, SUITE 500
LA JOLLA, CA

date	2/10/2020	detailed	D. SANCHEZ
designed	K. MATHEY	checked	-

MONTEREY COUNTY, CA

CAL FLATS
SUBSTATION 60 AND BESS SITE LAYOUT
PLAN VIEW

project	contract
drawing	rev. 0
CA FLATS-GP-005	
sheet 5 of 6 sheets	file CA FLATS-GP-005.dwg

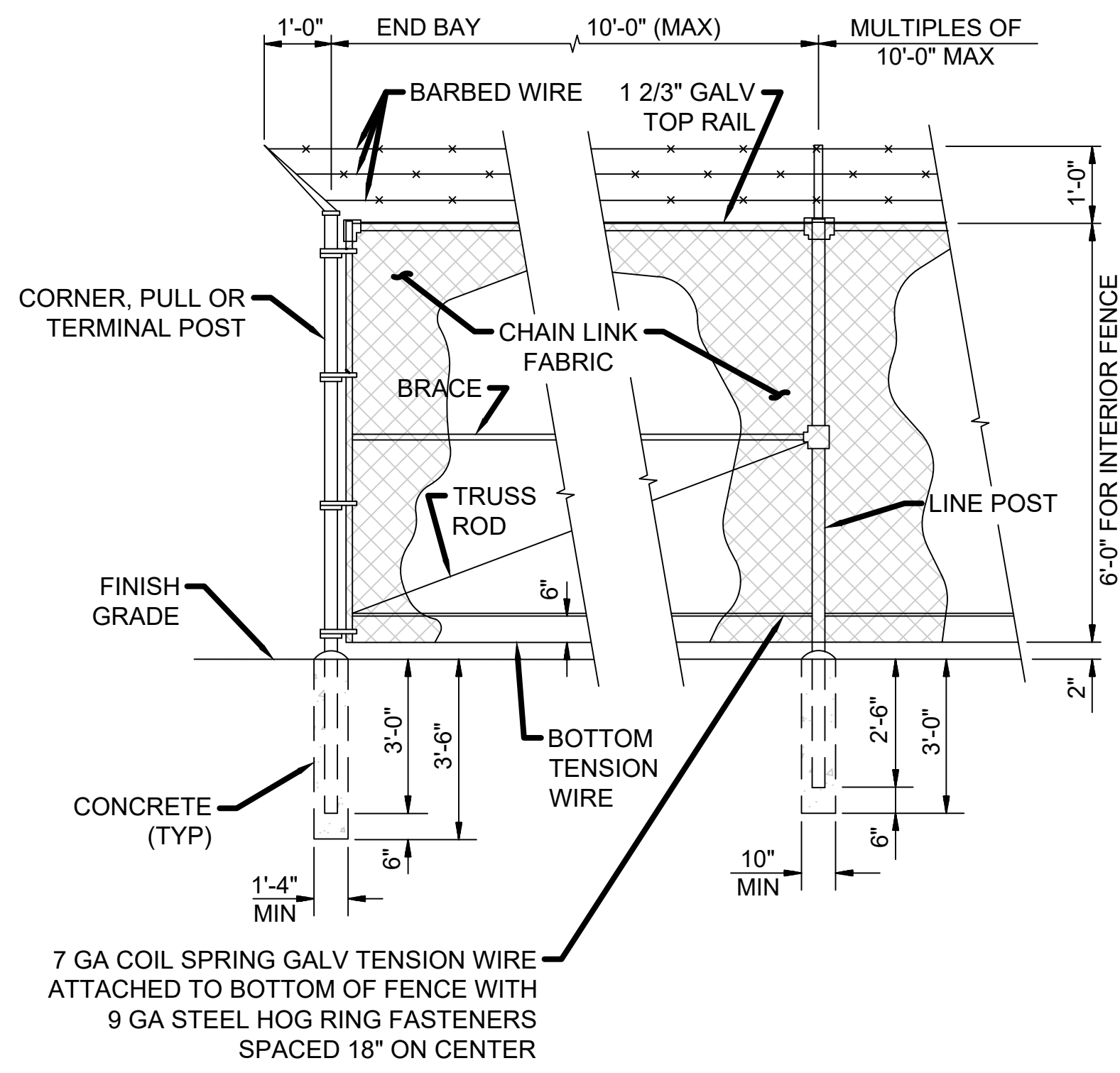

NOTE:
 1. APPLY BARBED WIRE AS SHOWN FOR SECURITY FENCING AROUND PERIMETER OF YARD. OMIT BARBED WIRE FOR INTERIOR FENCING WITHIN THE SECURITY FENCING.

SECURITY FENCE
 NTS

1
005

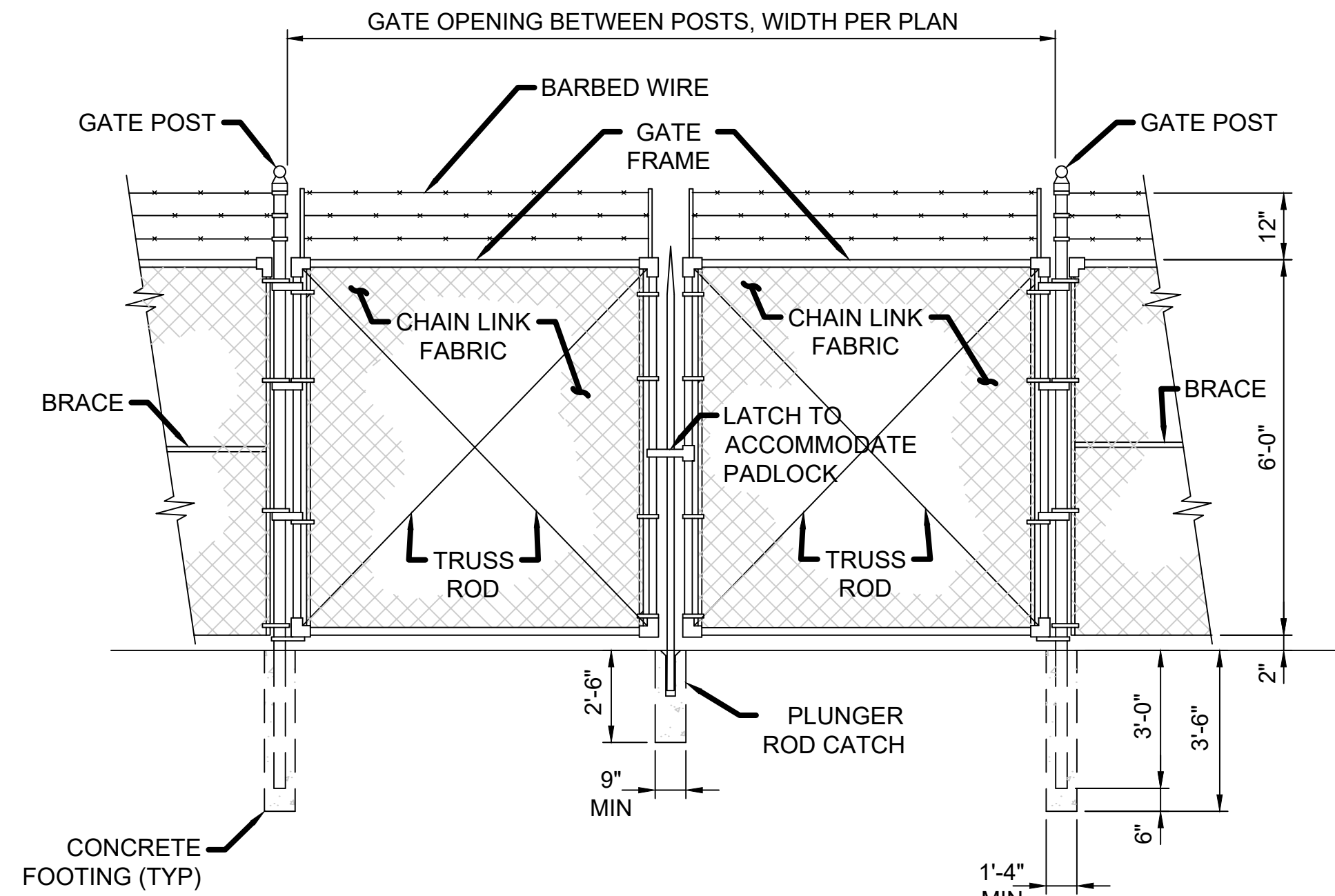

20' ACCESS GATE
 NTS

2
005

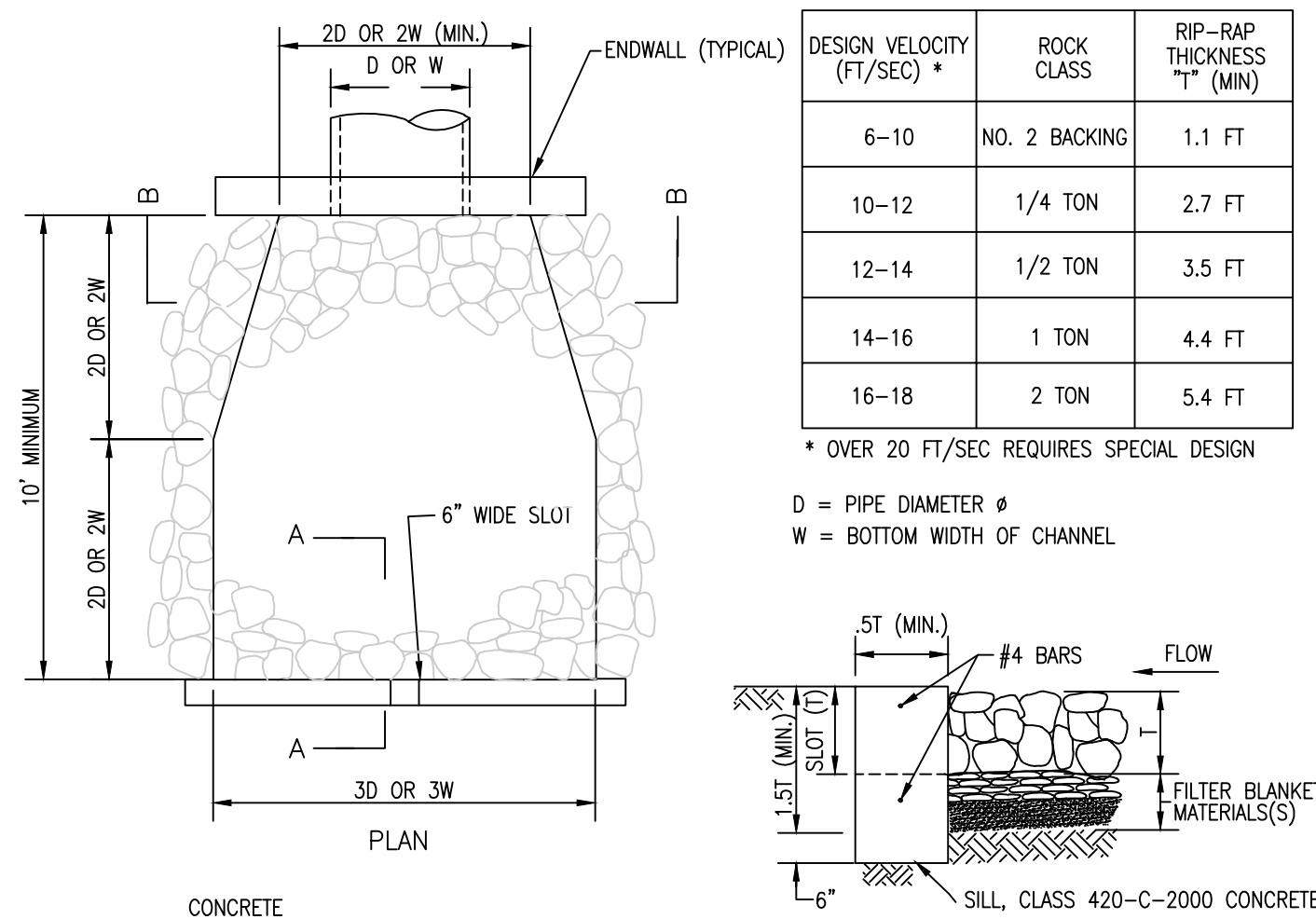

NOTES:
 1. PLANS SHALL SPECIFY:
 (A) ROCK CLASS AND RIP-RAP THICKNESS (T). T SHALL BE AT LEAST 1.5 TIMES THE NOMINAL EQUIVALENT DIAMETER OF STONE (d₅₀) OF THE SPECIFIED RIP-RAP.
 (B) FILTER BLANKET MATERIAL, NUMBER OF LAYERS AND THICKNESS.
 2. RIP-RAP SHALL BE EITHER QUARRY STONE OR BROKEN CONCRETE (IF SHOWN ON PLANS). COBBLES ARE NOT ACCEPTABLE.
 3. RIP-RAP SHALL BE PLACED OVER FILTER BLANKET MATERIAL, WHICH MAY BE EITHER GRANULAR MATERIAL OR NON-WOVEN GEOTEXTILE FILTER FABRIC, MATERIAL AT WEIGHT SPECIFIED IN PLANS OR SPECIFICATIONS.
 4. SEE TABLE 200-1.7 IN THE SAN DIEGO REGIONAL SUPPLEMENT TO GREENBOOK FOR SELECTION OF FILTER BLANKET.
 5. RIP-RAP ENERGY DISSIPATORS SHALL BE DESIGNATED AS EITHER TYPE 1 OR TYPE 2. TYPE 1 SHALL BE WITH CONCRETE SILL. TYPE 2 SHALL BE WITHOUT SILL.

RIP RAP
 NTS

3
005



NOTES:
 1. PROVIDE "WARNING HIGH VOLTAGE" SIGNS ON ALL SECURITY CHAIN LINK GATES AND FENCES AT EACH CORNER AND EVERY 50 FEET.
 2. PROVIDE "PRIVATE PROPERTY NO TRESPASSING VIOLATORS WILL BE PROSECUTED" SIGNS ON ALL SECURITY CHAIN LINK GATES AND FENCES EVERY 250 FEET.
 3. SIGNS SHALL MEET OWNER'S APPROVAL PRIOR TO PURCHASE.

SIGNAGE FOR CHAIN LINK FENCE
 NTS

4
005

no.	date	by	ckd	description
2-11-20				ISSUED FOR REVIEW



NOT FOR CONSTRUCTION

BURNS MEDONNELL

4225 EXECUTIVE SQUARE, SUITE 500
 LA JOLLA, CA

date	2/10/2020	detailed	D. SANCHEZ
designed	K. MATHEY	checked	

CapitalDynamics

MONTEREY COUNTY, CA

CA FLATS
 SUBSTATION 60 AND BESS SITE LAYOUT
 DETAILS

project	contract
drawing	rev. 0
CA FLATS-GP-006	
sheet 6 of 6 sheets	file CA FLATS-GP-006.dwg