

Attachment D

This page intentionally left blank.

**Before the Board of Supervisors in and for the
County of Monterey, State of California**

Resolution No.

Resolution of the Monterey County Board of Supervisors to:)
1. Certify that it has considered an addendum together with the FEIR for the General Plan;)
2. Adopt the Design Guidelines for Exterior Lighting which defines lighting terms and details specific performance criteria to implement Policy LU-1.13 of the 2010 Monterey County General Plan.)
)
[REF130036, Exterior Lighting Criteria, non-coastal area])

WHEREAS, pursuant to Article XI, section 7 of the California Constitution, the County of Monterey (“County”) may adopt and enforce ordinances and regulations not in conflict with general laws to protect and promote the public health, safety, and welfare of its citizens.

WHEREAS, future development allowed by the General Plan in Monterey County will result in new sources of nighttime lighting. These new sources may result in light trespass, light pollution, and glare. Light trespass is unwanted light from a neighboring property or roadway and can be both a nuisance and a health and safety risk. Glare and light pollution could result in sky glow, the haze of light that surrounds highly populated areas. Excessive nighttime lighting could alter the visual appearance of Monterey County landscapes, disrupt flora and fauna life cycles, and reduce the ability to see and enjoy the night sky.

WHEREAS, excessive glare and light pollution can be minimized through proper light fixture design and shielding. The 2010 General Plan Land Use Element Policy LU-1.13 states that all exterior lighting shall be unobtrusive and constructed or located so that only the intended area is illuminated, long range visibility is reduced, and off-site glare is fully controlled. The policy calls for the development of enforceable design guidelines to guide the review and approval of exterior lighting with specific criteria on the direction of light, shielding, and where lighting is allowed.

WHEREAS, on December 11, 2013 the Planning Commission conducted a public workshop to consider types of exterior lighting regulations and related General Plan policies. Following the Planning Commission workshop, both regulations and design guidelines have been developed to allow both flexibility and enforceability.

WHEREAS, the Design Guidelines for Exterior Lighting defines lighting terms and provides specific performance criteria for the location/direction of fixtures, fixture design, and number of fixtures for projects. Additionally, the document addresses exceptions for when the guidelines would not apply, provides information on energy efficiency and best management practices as it relates to exterior lighting, and includes visual aids for various types of acceptable and non acceptable lighting fixtures.

WHEREAS, the Final EIR for the 2010 General Plan was certified by the Board of Supervisors on October 26, 2010. The document determined that the alteration of the localized visual character and the introduction of new sources of light and glare in designated growth areas from implementation of the General Plan would have significant and unavoidable impacts. An addendum to the EIR has been prepared pursuant to CEQA Guidelines section 15164 for adoption of this ordinance because none of the conditions described in CEQA Guidelines section 15162 calling for the preparation of a subsequent or supplemental EIR have occurred. As found by the EIR, the Design Guidelines and enforcement of these guidelines for new exterior lighting in inland Monterey County would minimize impacts of new light sources and glare resulting from these light sources, but would not reduce significant effects to a level of less than significant. Therefore, no revisions to the Final EIR are necessary pursuant to Section 15164 of the CEQA Guidelines.

WHEREAS, the Design Guidelines have been sent to interested parties and stakeholders for review, including the Monterey Institute for Research in Astronomy, Streamline Task Force, Turn Down the Lights, and Monterey County Sherriff's office, and staff have considered and taken into account all recommendations.

WHEREAS, on November 18, 2015, the Planning Commission held a duly noticed public hearing and recommended that the Board of Supervisors 1) consider the addendum together with the FEIR for the General Plan, 2) adopt an ordinance amending Title 21, and 3) adopt a resolution adopting the Design Guidelines for Exterior Lighting.

WHEREAS, the Board of Supervisors, on this same date, has adopted an ordinance that amends Title 21 of Monterey County Code to add Chapter 21.63 that establishes a process for adoption of design guidelines and specifically provides for adoption of Design Guidelines for Exterior Lighting; and revises the site development standards in all zoning districts to require review and approval of exterior lighting by the RMA-Director of Planning for consistency with the Design Guidelines for Exterior Lighting.

NOW, THEREFORE, BE IT RESOLVED, that the Board of Supervisors does hereby:

- a. Certify that it has considered an addendum together with the FEIR for the 2010 General Plan;
- b. Adopt the Design Guidelines for Exterior Lighting, attached hereto as Exhibit 1 and incorporated by reference.

PASSED AND ADOPTED on this _____, by the following vote, to-wit:

AYES:

NOES:

ABSENT:

I, Gail T. Borkowski, Clerk of the Board of Supervisors of the County of Monterey, State of California, hereby certify that the foregoing is a true copy of an original order of said Board of Supervisors duly made and entered in the minutes thereof of Minute Book___ for the meeting on _____.

Dated:

Gail T. Borkowski, Clerk of the Board of Supervisors
County of Monterey, State of California

By _____
Deputy



Design Guidelines for Exterior Lighting

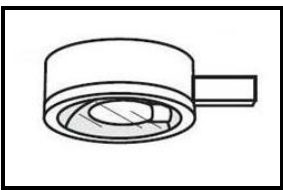
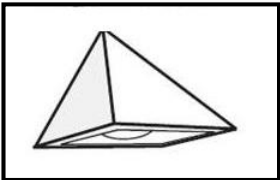
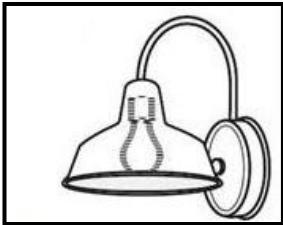
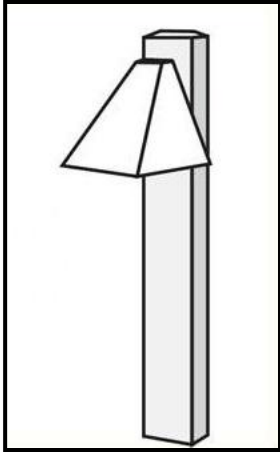

Adopted by the Board of Supervisors on January 26, 2016

Design Guidelines for Exterior Lighting

1. Purpose

The purpose of the Design Guidelines for Exterior Lighting is to implement Policy LU 1.13 of the General Plan that requires exterior lighting to be unobtrusive, reduce off-site glare, and only light an intended area. The design guidelines establish criteria for the location and direction of fixtures, number of fixtures, and design of fixtures. This document provides information on energy efficiency and best management practices for exterior lighting and visual aids for various types of acceptable light fixtures.

2. Applicability

These guidelines will be applicable to the non-coastal areas of Monterey County and enforceable by the Director of Planning. For any new development that includes exterior lighting, all exterior lighting shall be consistent with the design guidelines. The following exceptions apply:

1. Navigational lighting (airports, heliports, communication towers);
2. Seasonal lighting;
3. Solar path lighting;
4. Temporary lighting for activities of a limited duration such as emergency activities, construction, and agricultural harvesting;
5. Lighting for national monuments and national parks; and
6. Lighting for national, state or locally registered historic buildings or structures to the extent that the lighting contributes to the historic attributes of the building or structure.

3. Definitions

Direct Illumination – the direct view of a light source

Fully shielded - shielding that does not allow the light source to protrude outside the shield

Glare – Direct Illumination of intensity great enough to reduce a viewer’s ability to see

Light fixture – a complete lighting unit consisting of a lamp or lamps together with the parts designed to distribute the light, position and protect the lamps, and connect to power supply

Light source – source of artificial light in the form of a bulb or lamp

Light trespass – direct illumination that can be seen from adjacent property

Light pollution – artificial light which causes a detrimental effect on the environment, astronomical research or enjoyment of the night sky or causes undesirable glare or unnecessary illumination of adjacent property

Shielding – a barrier around a fixture that helps to conceal the light source and direct light to an intended area

Temporary lighting – lighting used for activities of a limited duration, e.g., emergency activities, construction, agriculture, etc.

Translucent – allowing the passage of diffused light

Transparent – allowing the direct passage of light

Design Guidelines for Exterior Lighting

4. Energy Efficiency

The State of California has adopted regulations for energy efficiency within the California Building Code (Title 24, Part 6), which is updated every three years. This is implemented through Title 18 of Monterey County Code. This code implements two things: 1) default lighting zones for the entire state, and 2) mandatory lighting standards for non residential projects. These standards include wattage allowance for projects according to the lighting zones (state parks, rural, urban areas). The purpose of the zones is to appropriately limit wattage for projects within the area to the surrounding environment. Additionally, these standards include mandatory requirements for exterior lighting, such as time-switch lighting controls, daylighting controls, and motion sensing controls. RMA-Building Services ensures consistency of these regulations during review of construction permits.

Utilization of energy efficient light bulbs provides long term financial benefits and lessens impact on the environment. Typical energy efficient light bulbs include halogen incandescent, compact fluorescent lamps (CFL), and light emitting diode (LED). These light bulbs will provide the same illumination while using significantly less energy and have a longer life expectancy than an average light bulb. Other elements of energy efficient lighting are proper fixture design, placement, and best management practices. If a light is properly shielded and directed, the energy is being used more efficiently to light the intended area.

Best management practices include:

- Retrofitting less energy efficient bulbs (incandescent)
- Turning off lights when not in use
- Utilizing motion sensors on all exterior lights
- Utilizing warm light bulbs (typically 2700-3000 Kelvin)

5. Performance criteria

Implementation of the following performance criteria will result in exterior lighting that limits offsite glare, reduces energy consumption, and lessens impacts to light pollution and flora and fauna:

a. Location & Direction of fixtures

- angled vertically downward
- directed at an intended area
- located/mounted on existing structures, poles, or ground
- fixture placement will not result in direct illumination of adjacent properties

b. Fixture Design

- Fully shielded
- Opaque shielding material is optimal
- Shielding material may be translucent for residential fixtures of low intensity
- Fixture should not utilize sag lens or refracted light components

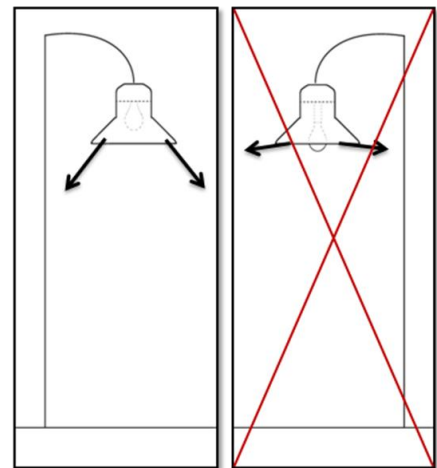

Design Guidelines for Exterior Lighting

c. Number of fixtures

- minimum fixtures necessary (for safety and as required by MCC Building Code) to achieve lighting of intended area(s)

6. Examples of acceptable light fixtures

The following images represent fixtures that utilize the performance criteria in Section 5, in comparison to fixtures that do not. Acceptable fixtures are not limited to those contained in this Section; the online resources below can guide applicants to fixtures that are nighttime friendly. The general theme is that the acceptable fixtures *fully shield* the light source to ensure the light cascades downward. This is accomplished by placing the light bulb inside a fixture shield that light cannot pass through. If the design of a fixture does not provide adequate shielding, the light may direct upwards into the sky as opposed to the intended area. These unacceptable fixtures contain features like sag lens and refractors that extend the light source outside of the fixture shield, resulting in light that projects outward, upward, and downward. Unacceptable fixtures produce glare, are less energy efficient, and contribute to light pollution.



RULE OF THUMB: if you can see the light bulb extending below the fixture from outside the area intended to be illuminated, the shielding is inadequate. Search acceptable fixtures [here](#).

6.a. PATH/BOLLARD LIGHTING

Acceptable bollards utilize shielded hoods and are directed downwards towards the path. Many unacceptable bollards build the lighting into the bollard without shielding or utilize refracting material, which directs the light outward instead of onto the path.

UNACCEPTABLE

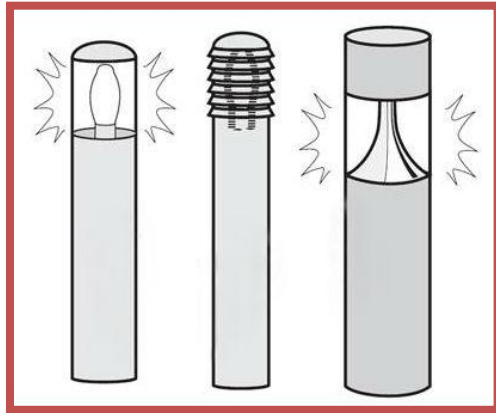

ACCEPTABLE:

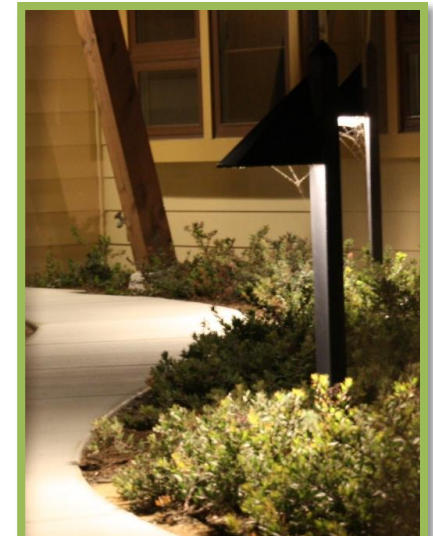
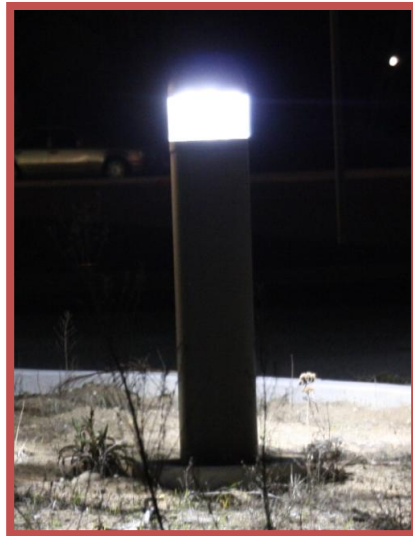
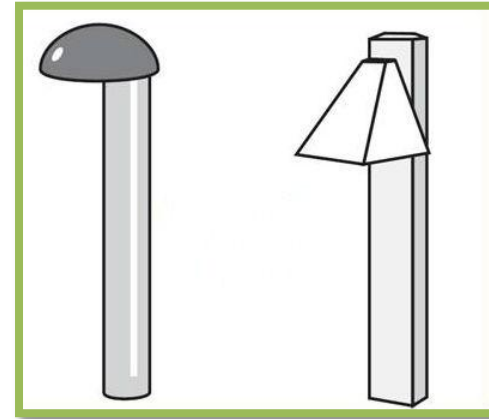

6.b. BUILDING MOUNTED LIGHTING

Building mounted lighting is used in industrial and commercial settings, and typically doubles as safety lighting which requires a higher intensity bulb. Fully shielded lights are of utmost importance here, as utilizing translucent fixtures will not sufficiently minimize glare from a high intensity bulb. Light fixtures that utilize drop-lens or sag-lens are not acceptable, as the light source is then exposed and results in glare.

UNACCEPTABLE

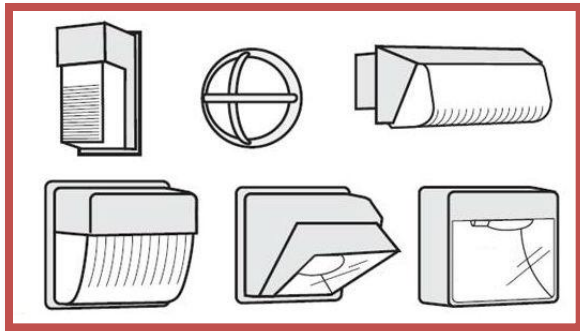

ACCEPTABLE

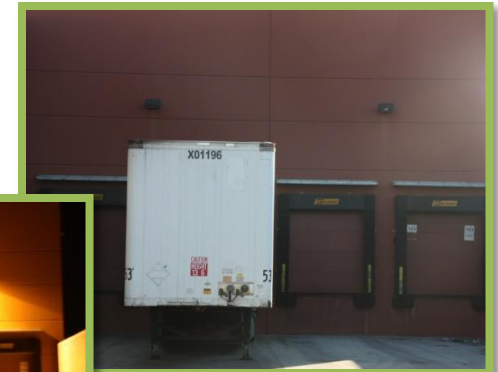
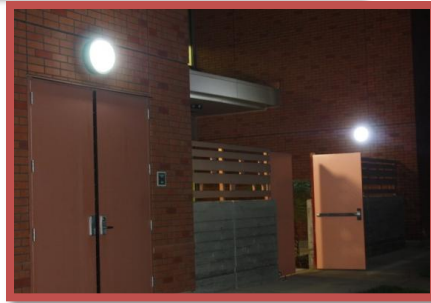
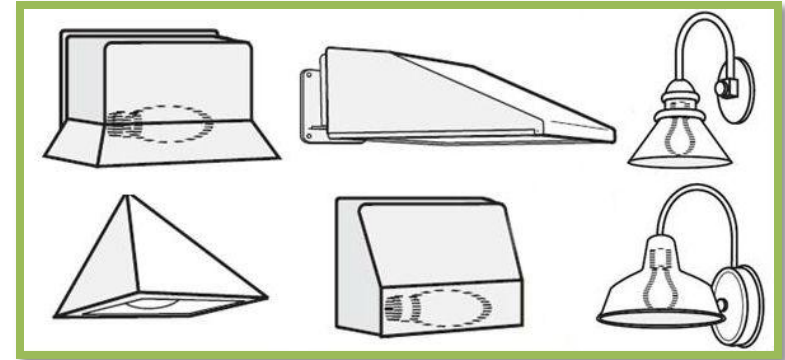

6.c. RESIDENTIAL LIGHTING

There are many forms of decorative fixtures for residential lighting, both pole and building mounted. Key components would be to utilize recessed lighting elements. Residential lighting that use translucent material to cover the light source may be acceptable if the bulbs are of sufficiently low intensity.

UNACCEPTABLE

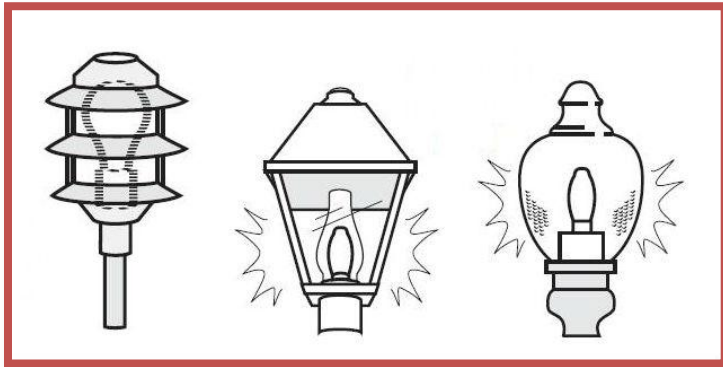

ACCEPTABLE

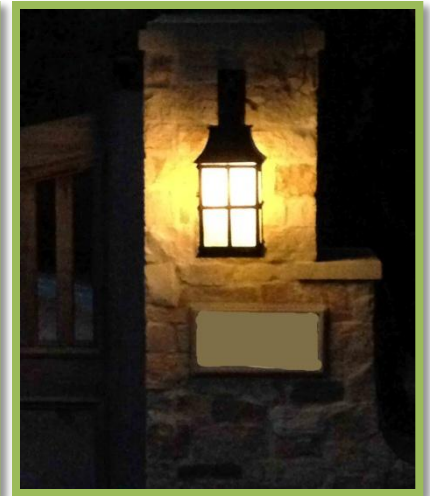
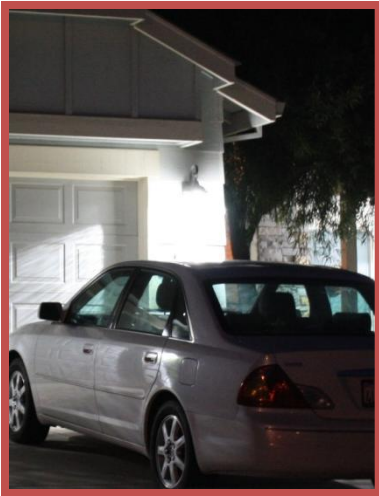

6.d. STREET LIGHTING (ped/bike)

Pedestrian and Vehicle street lighting differ in that vehicle lighting poles tend to be taller and spaced farther apart. Pedestrian lighting can be fixed on shorter poles and placed closer together to create a pedestrian scale setting. In both cases, bulbs are typically of a high wattage and require fully shielded fixtures. The light source should only be seen if walking under the pole.

UNACCEPTABLE

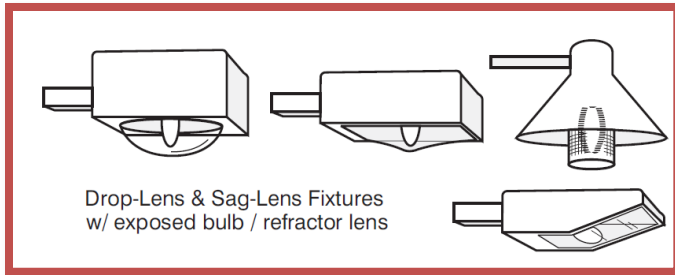

ACCEPTABLE

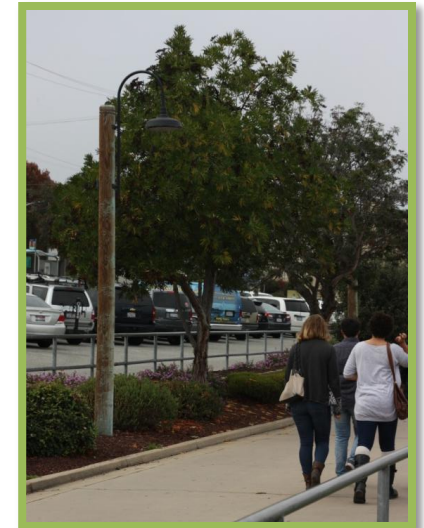
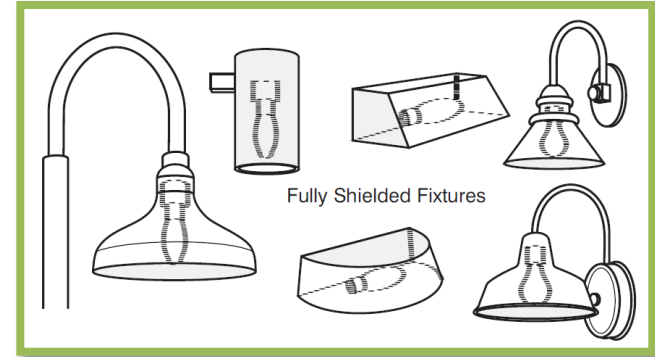

6.d. STREET LIGHTING (vehicle)

Both street and pedestrian lighting is typically permitted through larger developments such as subdivisions or in community services areas. These discretionary processes will allow for public participation of a particular style of fixture design; however the fixtures will need to comply with Section 5 of this document.

UNACCEPTABLE

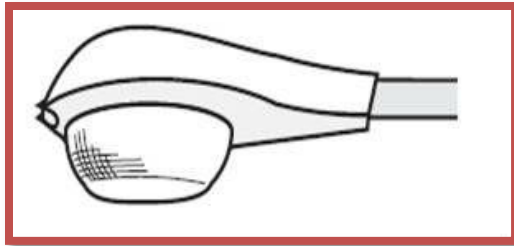

ACCEPTABLE

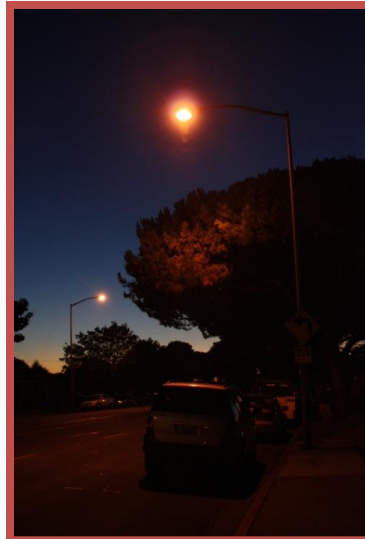
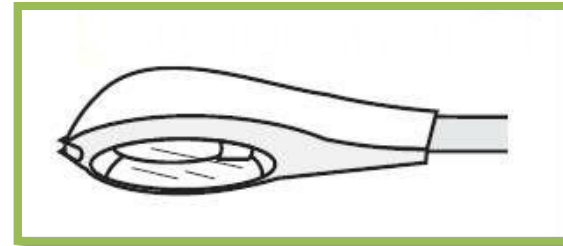

6.e. CANOPY LIGHTING

Canopy lighting is utilized under awnings and canopies in both residential and commercial areas. Commercial examples are for bank ATM's and covered walkways, and residential canopies are used on decks and outdoor patios. In either case, the light fixture should be recessed into the ceiling or have shielded sides if mounted onto the ceiling.

UNACCEPTABLE

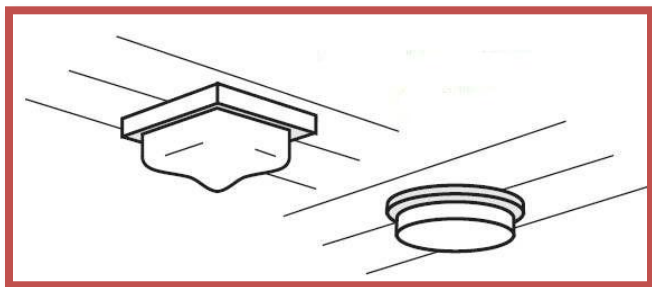

ACCEPTABLE

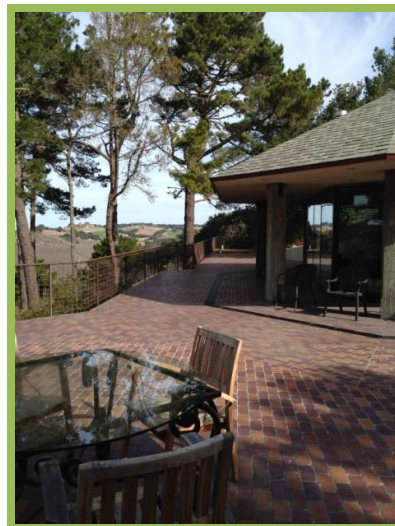
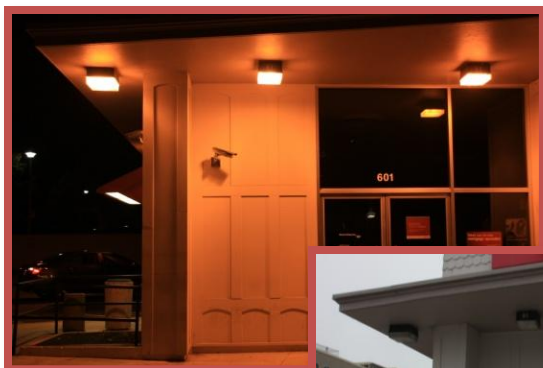
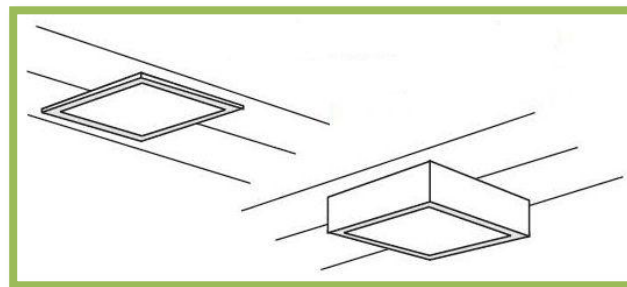

6.f. SAFETY LIGHTING

Typical lights used for safety are floodlights and barn lights. A common mistake with safety lighting is an attempt to use only one or two high intensity lights to provide sufficient illumination for an entire property. These lights are installed and angled outward and/or upward to light into the distance; however this only produces a significant amount of glare that can be viewed directly offsite and from a distance. Floodlights require shield hoods and should be directed downward. If necessary, appropriately shielded lights should be installed at intervals to cover the property's safety needs.

UNACCEPTABLE

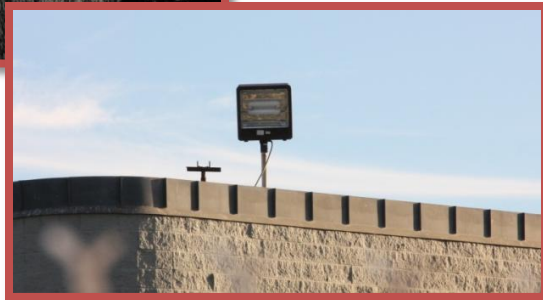
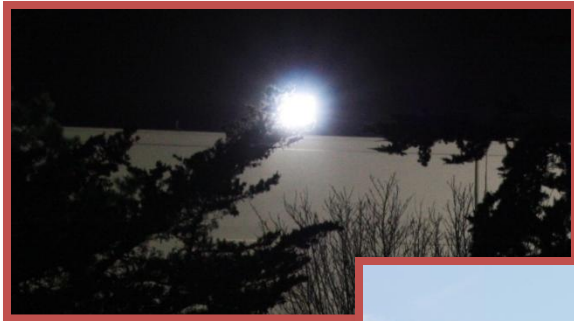
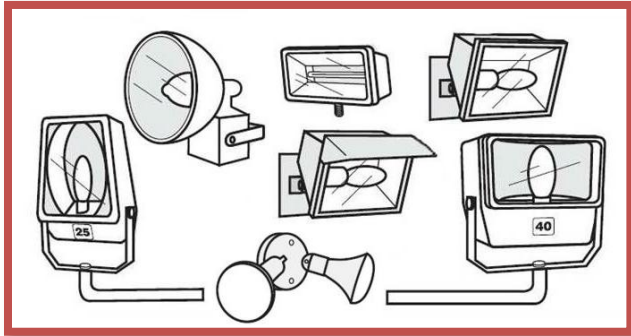

ACCEPTABLE

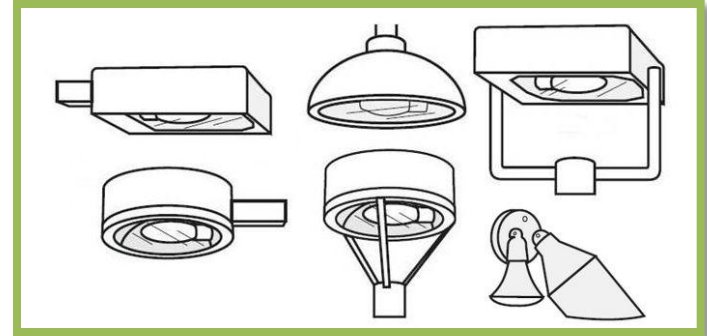

6.g. SIGN LIGHTING

Appropriate sign lighting depends heavily on the surrounding environment. Fixtures attached to the top of the sign are preferable, if angled downward. Fixtures attached to the ground, bottom, or side of the sign may be appropriate if angled directly parallel to the sign, located at a limited distance from the sign to avoid glare from the street, and of a proportionately smaller size than the sign itself. These lights may be appropriate if the surrounding environment (other buildings, landscape screening) will block all glare from being seen from the street or neighboring property. If lighting is located in an urban and/or commercial environment, signs may utilize backlighting, as these areas tend to be more illuminated at night.

UNACCEPTABLE

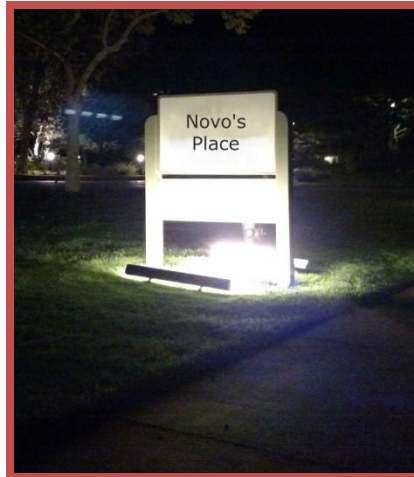
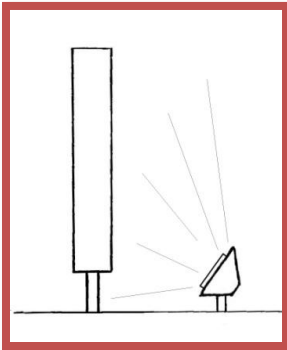

ACCEPTABLE

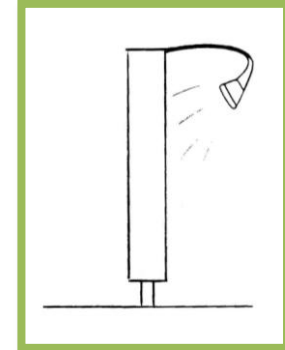
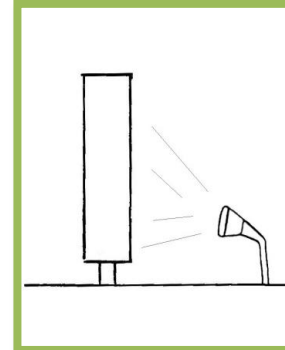

6.h. LANDSCAPE LIGHTING

Lighting is often used to accentuate landscape features such as art fixtures, statues, and gardens in both residential and commercial areas. Landscape lighting may be allowed when there is an intended area to be lit and the fixture achieves the Performance Criteria in Section 5. These fixtures come in many forms, including solar pavers and pillar lighting. The key to providing appropriate landscape lighting is to utilize shielding, low intensity bulbs (below 50 lumens), and minimize usage. The County of Monterey does not encourage the use of fixtures that result in upward lighting, however if proposed in a manner that achieves the Performance Criteria in Section 5, it may be allowed in limited circumstances. Landscape lighting may utilize screening by other landscape features, such as shrubbery and fencing.

