

WIRELESS COMMUNICATION SITE LEASE AGREEMENT

THIS WIRELESS COMMUNICATION SITE LEASE AGREEMENT (hereinafter "Agreement") is made and entered into by and between the **County of Monterey**, a political subdivision of the State of California (hereinafter "LESSEE"), with an address at c/o Real Property Specialist, 855 E. Laurel Drive, Building C, Salinas CA 93905, and **Crown Castle MU LLC**, a Delaware limited liability company (hereinafter "LESSOR"), with its principal place of business at 2000 Corporate Drive, Canonsburg, Washington County, Pennsylvania 15317.

In consideration of the mutual covenants contained herein and intending to be legally bound hereby, LESSOR and LESSEE hereby agree as follows:

1. PROPERTY, PREMISES, LICENSE TO INSTALL, MAINTAIN AND OPERATE EQUIPMENT AND ACCESS TO PROPERTY:

- (A) **Property.** LESSOR is the owner, lessee, manager or operator of that certain real property referred to as Bryant Canyon (LESSOR BU# 839198) as more particularly described in Exhibit "A" attached hereto and made a part hereof (the entirety of LESSOR's property is referred to hereinafter as the "Property").
- (B) **Premises, License to Install, Maintain and Operate Equipment.** LESSOR hereby grants to LESSEE a license to install, maintain, and operate the Equipment (as such term is defined in Section 2 below) within the space described in, and subject to, the approved "Site Engineering Application" and "Tower Level Drawing" attached hereto as Exhibit "B", and as shown in the "Site Plan" attached hereto as Exhibit "C". Such license is subject to LESSOR's "Site Rules" attached hereto as Exhibit "E", or its successor, issued by LESSOR from time to time, and is restricted exclusively to the installation, maintenance and operation of the Equipment consistent with the specifications and in the locations identified in Exhibit "B" and Exhibit "C" (the "Premises"). If the Site Rules are modified by Licensor after the effective date of this Agreement, then such modifications to the Site Rules shall not apply to this Agreement unless they are: (i) reasonable; (ii) provided by Licensor to Licensee; and (iii) evidenced by an amendment to this Agreement.
- (C) **Access to Property.** Subject to the requirements as set forth in Section 3 and Section 6 below, LESSEE shall have the non-exclusive right for pedestrian and vehicular ingress to and egress from the Property over the designated access area to the Property as described in Exhibit "A", seven (7) days a week, twenty-four (24) hours a day, subject to any restrictions in the lease from which LESSOR derives its rights in the Property (the "Prime Lease", a redacted copy of which is attached hereto as Exhibit "D") or any underlying easement, for the purposes of installing, maintaining, operating and repairing the Equipment, together with a license to install, maintain and operate and repair utility lines, wires, cables, conduits, lines, pipes or any other means of providing utility service, including electric and telephone service, to the Premises. LESSOR shall have no duty to

Initials CS MS

Wireless Site Lease Agreement – County of Monterey and Crown Castle MU LLC

RFI# 9795
Page 1 of 25

remove snow or otherwise maintain the access area. LESSOR and LESSEE acknowledge that LESSEE's use of the Property is subject and subordinate to the Prime Lease. LESSEE agrees to be bound by and to perform all of the duties and responsibilities required of the lessee, grantee or licensee as set forth in the Prime Lease to the extent they are applicable to the access to and use of the Property.

2. PERMITTED USE:

Subject to the terms of this Agreement, LESSEE may use the Premises at the Property to install, operate and maintain certain wireless communications base station equipment and antennae and other appurtenant and incidental equipment, including, but not limited to, LESSEE's cables, wires, radios, radio shelter or cabinet, and related transmission and reception hardware and software, and other personal property (hereinafter the "Equipment"), and LESSEE shall transmit and receive only within the FCC licensed frequency ranges and at the power levels specified herein. All Equipment to be installed under this Agreement shall be clearly marked by LESSEE with its identifying information which shall include the identity and phone number of LESSEE's emergency contact, FCC license number, and the transmitting and receiving frequencies of the Equipment.

3. IMPROVEMENTS ON THE PREMISES, PERFORMANCE OF WORK AND UTILITIES:

(A) Initial Installation and Maintenance of Equipment. LESSEE accepts the Premises in an "as is" condition. LESSEE shall have the right to finance and construct approved Equipment and related improvements on the Premises at LESSEE's sole cost and expense. LESSOR hereby consents to and approves of LESSEE's initial installation of Equipment at the Premises, as depicted on Exhibit "B" and Exhibit "C" attached hereto, including installation of an entry port on the shelter. Following the construction and initial installation of LESSEE's Equipment, LESSEE may thereafter, at its sole cost and expense, perform construction, maintenance, repairs and like-for-like replacements of its Equipment, as necessary, and appropriate for its ongoing business, subject to the terms of this Agreement, including, without limitation, this Section 3.

(B) Modifications to Equipment. LESSEE shall apply to make Modifications (as such term is defined below) to its Equipment by submitting a "Site Engineering Application" to LESSOR together with payment of a Modification application fee in the amount of One Thousand and 00/100 Dollars (\$1,000.00) to defray LESSOR's costs incurred in evaluating a "Site Engineering Application". A structural analysis, AM detuning study, or an intermodulation study may be required by LESSOR in connection with a proposed Modification, and LESSEE will be liable for the cost thereof. On or prior to full execution of this Agreement, LESSEE shall pay to LESSOR a fee in the amount of One Thousand Eight Hundred Dollars and 00/100 (\$1,800.00) to defray LESSOR's costs incurred in performing a structural analysis. Any approved Modification shall be evidenced by an amendment to this Agreement, and the "Site Engineering Application" approved by LESSOR describing the Modification shall be an exhibit to said amendment. For the purposes of this Agreement, a "Modification" shall mean: (i) any change (including upgrade) to the Equipment as specified herein or an approved "Site

Engineering Application”; (ii) any alterations in the frequency ranges or Federal Communications Commission (“FCC”) licensed allocation or power levels specified in the approved “Site Engineering Application”; (iii) any change in LESSEE’s technology protocol (e.g., GSM, CDMA, TDMA, iDEN, etc.); (iv) any addition of Equipment or occupation of additional space, or relocation of Equipment on the tower or on the ground, or relocation of ground space or equipment shelter space; or (v) any repair to the Equipment that affects tower loading capacity.

(C) LESSOR’s Improvements. LESSOR retains the right to make any improvements to the Premises and Property as reasonably deemed necessary by the LESSOR. Said improvements shall not be inconsistent with the LESSEE’s use of the Premises. Nothing contained in this Agreement shall be deemed or construed in any way to limit the LESSOR’s authority to exercise any right or power concerning the utilization of the Premises and Property. LESSEE’s use of the Premises shall be subordinate to the LESSOR’s use of the Property. LESSOR shall notify LESSEE of any intended use of the Property by the LESSOR which may be reasonably expected to affect LESSEE’s use of the Premises and any such use shall not be inconsistent with nor interfere with LESSEE’s use of the Premises.

(D) Conditions Precedent to Installation of or Modification to Equipment.

Notwithstanding anything to the contrary herein, the parties agree that LESSEE’s right to install Equipment or make a Modification to Equipment at the Property shall not commence until the following conditions are satisfied: (i) LESSOR has received any written consent required under the Prime Lease to allow LESSOR to license the Premises to LESSEE; (ii) a “Site Engineering Application” has been approved by LESSOR; (iii) the following fees have been paid to the extent applicable: the site application or Modification application fee, fee for a structural analysis, fee for an AM detuning study and fee for an intermodulation study; (iv) LESSEE has received all required permits (if any) for its installation of, or Modification to, the Equipment and all required regulatory or governmental approvals of LESSEE’s proposed use of the Property, and LESSOR has received copies of such required permits (if any) and such required regulatory or governmental approvals; and (v) LESSOR has received a waiver of any applicable rights of first refusal in and to the space or Premises that LESSEE identifies in the “Site Engineering Application”. With respect to LESSEE’s initial installation of Equipment at the Property, if any applicable conditions precedent are not satisfied within one hundred eighty (180) days of the date of full execution of this Agreement, either party shall have the right to terminate this Agreement upon written notice to the other party, unless and until all applicable conditions precedent are thereafter satisfied. Upon satisfaction of all conditions precedent, LESSOR shall provide written notice to LESSEE to confirm said satisfaction.

(E) Performance of Work. LESSEE may engage LESSOR to install LESSEE’s Equipment, and to make approved Modifications to LESSEE’s Equipment pursuant to this Section 3 (the “Work”), upon terms mutually agreed upon by the parties in writing; provided, however, in the event that LESSEE does not engage LESSOR to perform the Work, LESSEE shall (i) only engage a vendor approved by LESSOR to perform the Work and (ii) pay to LESSOR a fee upon completion of the Work for the purpose of defraying the

cost associated with LESSOR's inspection of the Work, the amount of which fee shall be determined by LESSOR in its sole discretion, provided, however, such fee shall not exceed Two Thousand Eight Hundred Dollars and 00/100 (\$2,800.00). Notwithstanding LESSOR's inspection of any Work not performed by LESSOR, LESSOR shall in no way be liable for any defect in the Work or any of the materials used, and LESSEE shall not rely on LESSOR's inspection of the Work as confirmation that no defects exist. All Work shall be performed in accordance with the standards set forth in the "Site Rules".

(F) Closeout Documentation. In the event that LESSEE engages LESSOR to perform any Work for LESSEE, LESSOR shall provide to LESSEE all as-built drawings and other installation documentation required by LESSOR ("Closeout Documentation") within forty-five (45) days of completion of the Work. In the event that LESSEE does not engage LESSOR to perform any Work for LESSEE and LESSEE engages a vendor approved by LESSOR to perform the Work in accordance with Section 2.5, LESSEE shall provide to LESSOR all Closeout Documentation within forty-five (45) days of completion of the Work.

(G) Utilities. LESSEE shall pay for all electricity and other utilities it uses. If separate metering is unavailable, LESSEE shall pay a reasonable share of such costs as allocated by LESSOR.

4. GOVERNMENTAL APPROVALS/TERMINATION: It is understood and agreed that LESSEE's ability to use the Premises is contingent upon its obtaining after the execution date of this Agreement all of the certificates, permits and other approvals relating to the presence and operation of the Equipment at the Premises (collectively the "Governmental Approvals") that may be required by any Federal, State or Local authorities, including all applicable FCC requirements. This requirement includes any necessary construction, building or use permits and compliance with any progress inspections that may be required by any regulatory body. In the event that any of such applications for such Governmental Approvals should be finally rejected through no fault of LESSEE or any Governmental Approval issued to LESSEE is canceled, expires, lapses, or is otherwise withdrawn or terminated by governmental authority through no fault of LESSEE so that LESSEE in its sole discretion will be unable to use the Premises for its intended purposes or the LESSEE determines that the Premises are no longer technically compatible for its intended use, LESSEE shall have the right to terminate this Agreement. Notice of the LESSEE's exercise of its right to terminate shall be given to LESSOR in writing by certified mail, return receipt requested, and shall be effective upon the mailing of such notice by the LESSEE. Upon such termination, this Agreement shall be of no further force or effect except to the extent of the representations, warranties and indemnities made by each party to the other hereunder. Otherwise, all the parties shall have no further obligations, including the payment of money, to each other.

5. INTERFERENCE:

(A) Interference to LESSEE's Operations. LESSOR agrees that neither LESSOR nor LESSOR's other users of the Property or property adjacent to the Property controlled or owned by LESSOR, whose equipment is installed or modified subsequently to LESSEE's Equipment ("Subsequent Use"), shall permit their equipment to interfere with LESSEE's

permitted transmissions or reception. In the event that LESSEE experiences Radio Frequency ("RF") interference caused by such Subsequent Use, LESSEE shall notify LESSOR in writing of such RF interference and LESSOR shall cause the party whose Subsequent Use is causing said RF interference to reduce power and/or cease operations in order to correct and eliminate such RF interference within seventy-two (72) hours after LESSOR's receipt of such notice. In the event LESSOR is notified of any RF interference experienced by LESSEE alleged to be caused by a Subsequent Use, the entity responsible for the Subsequent Use shall be obligated to perform (or cause to be performed) whatever actions are commercially reasonable and necessary at no cost or expense to LESSEE to eliminate such RF interference. LESSOR further agrees that any licenses or other agreements with third parties for a Subsequent Use will contain provisions that similarly require such users to correct or eliminate RF interference with LESSEE's operation of its Equipment following receipt of a notice of such interference.

(B) Interference by LESSEE. Notwithstanding any prior approval by LESSOR of LESSEE's Equipment, LESSEE agrees that it will not allow its Equipment to cause RF interference to LESSOR and/or other pre-existing uses of users of the Property in excess of levels permitted by the FCC. If LESSEE is notified in writing that its operations are causing such RF interference, LESSEE will immediately take whatever actions are commercially reasonable and necessary at no cost or expense to LESSOR to determine the cause of and eliminate such RF interference. If the interference continues for a period in excess of seventy-two (72) hours following receipt of such notification, LESSOR shall have the right to require LESSEE to reduce power and/or cease operations until such time as LESSEE can make repairs to the interfering Equipment. In the event that LESSEE fails to promptly take such action as agreed, then LESSOR shall have the right to terminate the operation of the Equipment causing such RF interference, at LESSEE's cost, and without liability to LESSOR for any inconvenience, disturbance, loss of business or other damage to LESSEE as the result of such actions.

6. AUTHORIZED PERSONS, NOTICE RELATING TO ACCESS, PERMITS AND APPROVALS:

(A) Authorized Persons; Safety of Personnel. LESSEE's right of access shall be limited to authorized employees, contractors or subcontractors of LESSEE, or persons under their direct supervision. LESSEE shall not allow any person to climb a tower at the Property without ensuring that such person works for a vendor approved by LESSOR for the subject work; provided, however, LESSEE may allow a person to climb a tower at the Property if either (i) LESSEE ensures that such person works for a vendor approved by LESSOR for the subject work, or (ii) LESSEE and LESSOR have entered into a Master Site Indemnity Agreement for non-qualified contractors as provided by LESSOR (an "MSIA"), such MSIA is active and applies to LESSEE's use of the Property, and LESSEE maintains the types and amounts of insurance required in such MSIA and is otherwise in compliance with all of the requirements set forth therein.

(B) Notice to District Manager. LESSEE agrees to provide LESSOR's designated District Manager (or other designated person) prior notice of any access to be made by LESSEE to the Property, except in the event of an emergency, in which event LESSEE shall

provide notice within twenty-four (24) hours following such emergency access. For the purposes hereof, an emergency shall be deemed to be either LESSEE's inability to transmit signals from, or receive signals at, the Site or a situation that reasonably appears to present an imminent risk of bodily injury or property damage.

(C) Permits, Authorizations and Licenses. LESSEE shall be solely responsible for obtaining, at its own expense, all permits, authorizations and licenses associated with its occupancy of Premises at the Property and utilization of Equipment thereon and shall promptly provide copies thereof to LESSOR.

(D) Zoning Approval. LESSEE must provide LESSOR with copies of any zoning application or amendment that LESSEE submits to the applicable zoning authority in relation to its installation or modification of Equipment at the Property, at least seventy-two (72) hours prior to submission to the applicable zoning authority. LESSOR reserves the right to (i) require that it be named as co-applicant on any such zoning application or amendment and/or (ii) require reasonable revisions to any such zoning application or amendment. LESSOR also reserves the right, prior to any decision by the applicable zoning authority, to approve or reject any conditions of approval, limitations or other obligations that would apply to the owner of the Property, or any existing or future Property licensee, as a condition of such zoning authority's approval; provided, however, LESSOR shall not unreasonably withhold or delay approval of any such conditions of approval, limitations or other obligations. LESSEE agrees that any Modification, or change in use of the Premises, as approved herein, may require an amendment hereto which may entitle LESSOR to additional compensation. LESSEE shall be solely responsible for all costs and expenses associated with (i) any zoning application or amendment submitted by LESSEE, (ii) making any improvements or performing any other obligations required as a condition of approval with respect to same and (iii) any other related expenses.

7. **LEASE FEE AND OTHER CHARGES:** For the rights granted under this Agreement, LESSEE shall pay to LESSOR a monthly fee (hereinafter "Lease Fee") in the amount of Five Hundred Fifty-Six and 24/100 Dollars (\$556.24) per month for the Equipment currently installed on the Property. LESSEE shall pay the first monthly Lease Fee within sixty (60) days after the Commencement Date (as such term is defined in Section 8 below). The then-current Lease Fee shall automatically increase by Three Thousand One Hundred and 00/100 Dollars (\$3,100.00) per month on the first day of the month in which installation of the additional antennas described in Exhibit B commences. The Lease Fee shall be prorated for any partial month occurring during the term of this Agreement. The Lease Fee shall be made to (need not be sent certified): **Crown Castle MU LLC**, at P.O. Box 203393, Houston, TX 77216.

For all subsequent years during the lease term, the LESSOR shall provide a written invoice to LESSEE prior to each anniversary of the Commencement Date. The Lease Fee shall be paid within thirty (30) days after LESSEE's receipt of written invoice from LESSOR; provided, however, LESSOR's failure to submit any invoice in accordance herewith shall not be construed as a waiver of any right thereto. LESSEE shall include the JDE Business Unit No. **839198** on or with each payment. The parties agree that, in the event that this Agreement is

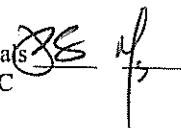

terminated prior to expiration of the year for which the Lease Fee was pre-paid, such Lease Fee shall be prorated accordingly, and LESSOR shall refund the balance to the LESSEE within thirty (30) days after such termination.

8. **TERM OF AGREEMENT:** The initial term of this Agreement shall commence on June 15, 2008 (the "Commencement Date"). The initial term shall expire on June 30, 2013 at twelve o'clock (12:00 p.m.) EST. Notwithstanding anything to the contrary herein, in the event that the Prime Lease terminates for any reason, this Agreement shall be deemed to have terminated effective as of the date of the termination of the Prime Lease.
9. **FISCAL OUT CLAUSE:** Notwithstanding any other provisions of this Agreement, LESSEE may, at its sole option, terminate this Agreement by providing at least thirty (30) days prior written notice to LESSOR in the event that funds have not been budgeted for leasing of the Premises described herein. Such termination shall be without penalty to LESSEE. Such right of termination shall not be construed so as to permit LESSEE to terminate this Agreement in order to lease other premises for a similar purpose in the same general area. LESSEE represents that it is its intent to lease said Premises for the full term unless financial conditions make it necessary for the Board of Supervisors not to budget funds therefor.
10. **EXTENSIONS:** This Agreement shall automatically be extended for three (3) additional five (5) year terms unless the either party provides written notice to the other of its election not to extend the term at least six (6) months prior to the end of the then current term.
11. **LEASE FEE INCREASES:** The Lease Fee shall be increased on the first anniversary of the Commencement Date and every anniversary of the Commencement Date thereafter by an amount equal to four percent (4%) of the Lease Fee paid for the previous year. LESSOR's failure to demand any such increase shall not be construed as a waiver of any right thereto and LESSEE shall be obligated to remit all increases notwithstanding any lack of notice or demand thereof.
12. **HOLDOVER:** LESSEE shall remove its Equipment from the Property prior to the expiration or termination of this Agreement. Should LESSEE's Equipment remain at the Property after the expiration or termination of this Agreement, no tenancy or interest in the Property shall result, but this "holding over" shall be an unlawful detainer and all such Equipment shall be subject to immediate removal. LESSEE shall, upon demand, pay to LESSOR, as a holdover fee, a sum equal to one-eighth (1/8) the annual Lease Fee (based on the amount of the Lease Fee at the time of said expiration or termination), for each month or partial month during which LESSEE shall "hold over" at the Property after the expiration or termination of this Agreement.
13. **ASSIGNMENT:** Neither this Agreement nor any rights hereunder shall be sold, transferred or assigned by the LESSEE without the written consent of LESSOR, which consent shall not be unreasonably withheld, conditioned or delayed. Any such assignment shall be evidenced by a form provided by LESSOR and executed by LESSOR, LESSEE and the assignee. Notwithstanding the above, LESSEE may assign this Agreement, without written consent by LESSOR upon one hundred eighty (180) days prior written notice to LESSOR, to LESSEE's

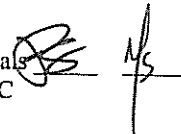

principal, or any wholly-owned subsidiary of its principal or to any entity which acquires all or substantially all of LESSEE's assets in the market defined by the FCC in which the Property is located by reason of a merger, acquisition, or other business reorganization. LESSEE shall not sublease or license its interest in this Agreement, either directly or through subsidiaries or affiliated entities. LESSEE shall not share the use of its Equipment with any third party.

- 14. NOTICES:** Any demand or notice which either party shall be required, or may desire, to make upon or give to the other hereunder shall be in writing and shall be delivered (i) by established express delivery service which maintains delivery records, (ii) personally upon the other, or (iii) by prepaid certified or registered mail, return receipt requested. All notices shall be effective upon receipt, or upon attempted delivery if delivery is refused. The notices shall be sent to the parties at the following addresses:

To LESSEE: County of Monterey
Public Works
Real Property Specialist
855 E. Laurel Drive, Building C
Salinas, CA 93905
Tel: (831) 755-4855
Fax: (831) 755-4688
salcidog@co.monterey.ca.us

With a copy that shall not constitute notice to:

Information Technology Department
c/o Assistant Director of Information Technology
1590 Moffett Street
Salinas, CA 93905
Tel: (831) 759-6919
Fax: (831) 759-6910
Email: dalbyd@co.monterey.ca.us

To LESSOR: Crown Castle MU LLC
2000 Corporate Drive
Canonsburg, PA 15317
Attn: Legal Department
Tel: (724) 416-2000
Fax: (724) 416-2353

Either party may, from time to time, designate any other address for this purpose by written notice to the other party. Either party for general communication may use telephone, email or facsimile.

- 15. ACKNOWLEDGMENT OF TITLE:** It is understood and agreed that LESSEE, by the acceptance of this Agreement and by the use or occupancy of said Premises, has not acquired

Wireless Site Lease Agreement – County of Monterey and Crown Castle MU LLC

Initials

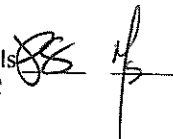

and shall not acquire hereafter any property rights or interest in or to said Premises (other than the leasehold interest granted herein), and LESSEE may use the Premises only as herein provided. LESSEE shall not have, nor will it obtain, any right or claim to the continued use of said Premises beyond that specifically given in this Agreement. LESSOR covenants that LESSEE, on paying the Lease Fee and performing all the terms, covenants, and conditions of this Agreement, shall peaceably and quietly have, hold and enjoy the Premises, subject to the terms, covenants and conditions set forth herein. LESSOR covenants that LESSOR has full power and authority to enter into and perform this Agreement and to grant the rights granted to LESSEE hereunder, subject to the terms, covenants and conditions set forth herein.

- 16. REPAIRS:** LESSEE shall be responsible for all maintenance and repairs of LESSEE's Equipment, and LESSEE shall keep its installation, including but not limited to, fencing and screening, in good, neat and clean condition in conformity with the standards of the local governing body regulations and the Site Rules. LESSEE shall be responsible for the timely repair of all damage to the Premises and Property caused by the negligence or willful misconduct of LESSEE, its employees, agents or business vendors.
- 17. INSPECTION:** The LESSOR shall have the right at all times to enter upon said Premises to inspect the Equipment and determine if said use is to the satisfaction of LESSOR; provided, however, that LESSOR shall not alter, adjust, move, disrupt or otherwise affect the operation of the LESSEE's Equipment, except as LESSOR may otherwise be permitted as set forth herein. If LESSOR alters, adjusts, moves, disrupts or otherwise affects the operation of LESSEE's Equipment during the inspection in such a manner to cause damage to LESSEE's Equipment, LESSOR shall be liable for the actual, direct damages to the Equipment.
- 18. INSURANCE AND INDEMNIFICATION:**
- (A) Mutual Indemnification.** Each party shall indemnify, defend and hold the other party, its affiliates, subsidiaries, directors, officers, employees and contractors, harmless from and against any claim, action, damages, liability, loss, cost or expense (including reasonable attorney's fees), resulting from or arising out of the indemnifying party's and/or any of its contractors', subcontractors', servants', agents' or invitees' use, acts, omission, or occupancy of the Property, except to the extent that such injury or property damage is due to the indemnified party's sole gross negligence or willful misconduct.
- (B) Insurance.** LESSEE shall maintain public liability and property damage coverage or program of self insurance with liability limits of not less than \$1,000,000 per occurrence for injury or death to one or more persons and property damage limits of not less than \$50,000 per occurrence, insuring against all liability of LESSEE and its authorized representatives arising out of and in connection with LESSEE'S use or occupancy of the Premises. LESSOR agrees that it will keep the building on the subject demised premises insured against loss or damage by fire.
- 19. CONDEMNATION:** If any part of the Property shall be taken under the power of eminent domain LESSOR and LESSEE shall be entitled to assert their respective claims in accordance with applicable state law.

JS JS

- 20. CASUALTY:** In the event that the Property, or any part thereof, is damaged by fire or other casualty not caused by LESSEE, LESSOR shall have ninety (90) days from the date of damage, if the damage is less than total destruction of the Property, in which to make repairs, and one hundred eighty (180) days from date of destruction, if the Property (including the tower structure) is destroyed, in which to replace the destroyed portion of the Property. If LESSOR fails for any reason to make such repair or restoration within the stipulated period and the damage or destruction effectively precludes LESSEE's use of the Property as authorized under this Agreement, then either party may, at its option, terminate this Agreement without further liability of the parties, as of the date of partial or complete destruction. If, for any reason whatsoever, LESSEE's use of the Property is interrupted due to casualty, in addition to the aforementioned termination right, LESSEE's sole remedy shall be abatement of the Lease Fee for the period during which LESSEE's use of the Property is interrupted. Except with regard to repair of the Property as stated in this Section 20, LESSOR shall not be responsible for any damage caused by vandalism or acts of God. In no event shall LESSOR be liable to LESSEE for damage to the Equipment or interruption or termination of LESSEE's operations caused by forces majeure or acts of God.
- 21. USE OF HAZARDOUS CHEMICALS:** LESSEE must inform LESSOR if it will house batteries or fuel tanks at the Property. The use of any other hazardous chemicals at the Property requires LESSOR's prior written approval. LESSEE agrees to provide to LESSOR no later than each January 15th, an annual inventory of its hazardous chemicals at the Property. Upon LESSEE'S request, LESSOR shall supply copies of any "Phase I" environmental investigation reports in its possession for the Property, unless such delivery is prohibited by agreement with a third party. LESSEE may commission any "Phase I" environmental assessments at its own expense, and shall provide copies of reports based on such studies to LESSOR. "Phase II" environmental assessments must be approved by LESSOR prior to initiation and a Phase II Environmental Investigation Access Agreement must be executed if LESSEE will use its contractor to perform the study. Notwithstanding the foregoing, the performance of any environmental study at the Property is subject to any restrictions in the Prime Lease.
- 22. CONDITION OF PREMISES UPON TERMINATION:** Within thirty (30) days after termination or expiration of this Agreement, LESSEE at its sole cost and expense shall remove all of LESSEE's Equipment from the Premises to the extent reasonably requested by LESSOR and restore the Premises as nearly as possible to the condition in which it existed immediately prior to the Commencement Date, including, but not limited to, removing rooftop mounts and tie downs (if applicable), electrical conduits, cabling and switches, whether underground or above-ground, reasonable wear and tear excepted.
- 23. REAL ESTATE TAXES:** LESSEE shall pay all personal property taxes assessed against the LESSEE's personal property that is located within the Property. LESSOR shall pay all real property taxes and all other fees assessed against the LESSOR's premises or LESSOR's personal property or improvements thereon owned and maintained by the LESSOR.
- 24. DEFAULT, REMEDIES AND WAIVER OF CONSEQUENTIAL DAMAGES:** Notwithstanding any other provision to the contrary contained herein this Agreement, in the event there is a default by the LESSEE with respect to any of the provisions of this

Agreement or its obligations under it, then the LESSOR shall give LESSEE written notice of such default. After receipt of such written notice, the LESSEE shall have ten (10) days to cure any monetary default and thirty (30) days to cure any non-monetary default (i.e., a default not related to timeliness of payments), provided that such thirty (30) day period will be extended as required if the nature of the cure is such that it reasonably requires more than thirty (30) days and the LESSEE commences the cure within the thirty (30) day period and thereafter continuously and diligently pursues the cure to completion. The LESSOR may not maintain any action or effect any remedies for default against the LESSEE unless and until the LESSEE has failed to cure the same within the time periods provided in this Section 24. All delinquent amounts shall bear interest at the lesser of one and one-half percent (1 ½%) per month, or the maximum amount permitted by law. Except as otherwise provided in this Agreement, neither party shall be liable to the other for consequential, indirect, special, punitive or exemplary damages for any cause of action whether in contract, tort or otherwise, hereunder.

25. GOVERNING LAW AND VENUE: The laws of the State of California, regardless of conflict of law principles, shall govern this Agreement. The duties and obligations of the parties created hereunder are performable in Monterey County, and such county shall be the venue for any action or proceeding that may be brought or arise by reason or connection with this Agreement.

26. RECORDING: LESSOR agrees to execute a memorandum of this Agreement that LESSEE may record with the appropriate Recording Officer using the format identified as Exhibit F, and LESSEE shall pay all costs associate with recording. The date set forth in the memorandum of this Agreement is for recording purposes only and bears no reference to Lease Fee payments. In the event that this Agreement is terminated prior to the end of its term, LESSEE grants to LESSOR a power of attorney to execute and record any instrument necessary to evidence said termination.

27. SUBORDINATION, NON-DISTURBANCE AND ATTORNMENT:

(A) Subordination. Subject to Section 27(B) below, this Agreement and LESSEE's rights hereunder are and will be subject and subordinate in all respects to: (i) any and all mortgages, deeds of trust or other deeds, and any similar security agreements that encumber the Property to secure the debt of LESSOR (collectively, "Security Instrument") from LESSOR in favor of any and all lenders, creditors, indenture trustees and similar parties (collectively, "Lender") insofar as the Security Instrument affects the property of which the Property forms a part; (ii) any and all advances to be made thereunder; and (iii) any and all renewals, extensions, modifications, consolidations and replacements thereof. Said subordination is made with the same force and effect as if the Security Instrument had been executed prior to the execution of this Agreement.

(B) Non-Disturbance. The subordination described in Section 27(A) is conditioned upon the agreement by Lender that, so long as this Agreement is in full force and effect and LESSEE is not in material default (beyond applicable notice and cure periods) hereunder, Lender, for itself and on behalf of its successors in interest, and for any person acquiring title to LESSOR's interest in the real property of which the Property forms a part (an

“Acquiring Party”) through a Conveyance (as such term is defined in Section 27(C) below), agrees that the right of possession of the Property and all other rights of LESSEE pursuant to the terms of this Agreement shall remain in full force and effect and shall not be affected or disturbed by Lender in the exercise of its rights under the Security Instrument.

(C) Liability of Parties. LESSEE and LESSOR agree (i) that any exercise by a Lender of its rights under the Security Instrument, including a foreclosure, sheriff’s or trustee’s sale under the power of sale contained in the Security Instrument, the termination of any superior lease of the Property and any other transfer, sale or conveyance of the LESSOR’s interest in the property of which the Property forms a part under peril of foreclosure or similar remedy, including, without limitation to the generality of the foregoing, an assignment or sale in lieu of foreclosure or similar remedy (“Conveyance”) shall be made subject to this Agreement and the rights of LESSEE hereunder and (ii) that the parties shall be bound to one another and have the same remedies against one another for any breach of this Agreement as LESSEE and LESSOR had before such Conveyance; provided, however, that Lender or any Acquiring Party shall not be liable for any act or omission of LESSOR or any other predecessor-in-interest to Lender or any Acquiring Party. LESSEE agrees that Lender may join LESSEE as a party in any action or proceeding to foreclose, provided that such joinder is necessary to foreclose on the Security Instrument and not for the purpose of terminating this Agreement.

(D) Attornment. LESSEE agrees that, upon receipt by LESSEE of notice to attorn from Lender or any Acquiring Party, along with reasonable supporting documentation, (i) LESSEE shall not seek to terminate this Agreement and shall remain bound under this Agreement, and (ii) LESSEE shall attorn to, accept and recognize Lender or any Acquiring Party as the licensor or lessor hereunder pursuant to the provisions expressly set forth herein for the then remaining balance of the Term of this Agreement and any extensions or expansions thereof as made pursuant hereto. LESSEE agrees, however, to execute and deliver, at any time and from time to time, upon the request of Lender or any Acquiring Party any reasonable instrument which may be necessary or appropriate to evidence such attornment.

28. COMPLIANCE WITH LAWS: LESSEE shall maintain and operate its Equipment during the term of this Agreement in compliance with all present and future rules and regulations of any local, State, or Federal authority having jurisdiction with respect hereto, including without limitation, the rules and regulations of the FCC, the Federal Aviation Administration (the “FAA”), and the Occupational Safety and Health Administration (“OSHA”)

29. RF EMISSIONS COMPLIANCE: LESSEE is aware of its obligation to comply with all applicable rules and regulations of the FCC pertaining to RF emissions standards, as well as applicable rules and / or regulations of any other federal or state agency (including but not limited to OSHA) having jurisdiction over the installation, operation, maintenance, and / or working conditions involving RF emissions and / or safety and work standards performed on or near communication towers and antennas. LESSEE agrees to be solely responsible for compliance with all applicable FCC and other governmental requirements with respect to installation, operation, and maintenance of its Equipment and for repairs to its Equipment at

the Premises. LESSEE will immediately remedy its operations to comply with such laws, rules, and regulations as they apply to its operations and / or the operations of all licensed users at the Premises to comply individually and in the aggregate with all applicable FCC and other governmental RF emissions standards.

- 30. REPLACEMENT AND RENOVATION OF TOWER:** LESSOR reserves the right, in its sole discretion, to renovate, replace or rebuild the tower structure, building, or shelter and related improvements thereof. In such event, LESSOR shall provide LESSEE with tower space suitable to allow LESSEE to continue to operate the Equipment in a substantially similar manner during any construction period. LESSOR shall be solely responsible for the costs associated with removing and re-installing the Equipment. LESSOR reserves the right to erect one or more towers on the Property. LESSEE shall have the right, subject to all governmental restrictions and any restrictions in the Prime Lease (if applicable) or otherwise binding on LESSEE's use of the Property, to temporarily locate a "cell on wheels" (a "COW") on the Property to provide such services as LESSEE deems necessary during any such renovation, replacement, or reconstruction by LESSOR for so long as adequate space is available and such COW does not interfere with such construction or use by other tenants and customers at the Property. The location of such COW shall be subject to LESSOR's approval, which shall not be unreasonably withheld or delayed, and LESSEE shall remove any such COW within ten (10) days after receipt of notice from LESSOR that the facility is available for the installation and/or operation of LESSEE's Equipment.
- 31. RF EXPOSURE:** LESSEE agrees to reduce power or suspend operation of its Equipment if necessary and upon reasonable notice to prevent exposure of workers or the public to RF radiation in excess of the then-existing regulatory standards.
- 32. LIENS:** LESSEE shall keep the Premises, the Property and any interest it or LESSOR has therein free from any liens arising from any work performed, materials furnished or obligations incurred by or at the request of LESSEE, including any mortgages or other financing obligations, and shall discharge any such lien filed, in a manner satisfactory to LESSOR, within thirty (30) days after LESSEE receives written notice from any party that the lien has been filed.
- 33. WITHDRAWAL OR TERMINATION OF APPROVAL OR PERMIT:** In the event any previously approved zoning or other permit of a government entity or agency affecting the use of the Property as a communications facility is withdrawn or terminated, this Agreement shall be deemed to have been terminated effective as of the date of the termination of the permit or approval.
- 34. NON-DISCLOSURE:** The parties agree that without the express written consent of the other party, neither party shall reveal, disclose or publish to any third party the terms of this Agreement or any portion thereof, except to such third party's auditor, accountant, lender or attorney or to a government entity or agency if required by law, regulation, subpoena or government order to do so. Notwithstanding the foregoing, either party may disclose the terms of this Agreement to any of its affiliated entities, and LESSOR may disclose the terms of this Agreement to any of its lenders or creditors or to third parties that are existing or potential lessees or licensees of space at the Property as may be reasonably necessary with

respect to the operation, leasing, licensing and marketing of the Property, including, without limitation, terms relating to LESSEE's permitted frequencies for the purposes of RF compliance tests and terms relating to LESSEE's Equipment installed, or to be installed, on the tower for the purposes of structural analysis.

35. MISCELLANEOUS:

- (A) **Prior Agreement Superseded.** This Agreement, including the exhibits attached hereto, constitutes the entire agreement and understanding between the parties, and revokes and supersedes all other oral or written offers, negotiations and other agreements between the parties, concerning the subject matter contained herein, including, without limitation, that certain Communications License Agreement between the parties with respect to LESSEE's use of the Property, which Communications License Agreement was entered into on May 14, 2002, to the extent that such Communications License Agreement, as may have been amended, is still in effect.
- (B) **Amendments.** This Agreement may be amended or modified only by an instrument in writing signed by the LESSEE and the LESSOR.
- (C) **Integration.** This Agreement, including the exhibits, represent the entire Agreement between the LESSEE and LESSOR with respect to the subject matter of this Agreement and shall supersede all prior negotiations, representations, or agreements, either written or oral, between the LESSEE and LESSOR as of the effective date of this Agreement, which is the date of later execution
- (D) **No Waiver.** No provision of this Agreement will be deemed to have been waived by either party unless the waiver is in writing and signed by the party against whom enforcement is attempted. No custom or practice which may develop between the parties in the administration of the terms of this Agreement shall be construed to waive or lessen any parties' right to insist upon strict performance of the terms of this Agreement. The rights granted in this Agreement are cumulative of every other right or remedy that the enforcing party may otherwise have at law or in equity or by statute, and the exercise of one or more rights or remedies will not prejudice or impair the concurrent or subsequent exercise of other rights or remedies.
- (E) **Non-exclusive Agreement.** This Agreement is non-exclusive and both LESSEE and LESSOR expressly reserve the right to contract with other entities for the same or similar services.
- (F) **Authority.** Any individual executing this Agreement on behalf of the LESSEE or the LESSOR represents and warrants hereby that here or she has the requisite authority to enter into this Agreement on behalf of such party and bind the party to the terms and conditions of this Agreement.
- (G) **Successors and Assigns.** Subject to any provision hereof restricting assignment or subletting by LESSEE, this Agreement shall bind the parties, their personal representatives, successors, and assigns.

(H) Severability. If any provision of this Agreement is invalid or unenforceable with respect to any party, the remainder of this Agreement, or the application of such provision to persons other than those as to whom it is held invalid or unenforceable, shall not be affected and each provision of this Agreement shall be deemed valid and enforceable to the fullest extent permitted by law. The parties agree to promptly renegotiate in good faith any provision held to be invalid or unenforceable under this paragraph.

(I) Time is of the Essence. Time is of the essence in each and every provision of this Agreement.

IN WITNESS WHEREOF, the parties hereto have executed this Agreement on the dates appearing below their respective authorized signatures.

LESSEE: (County of Monterey)

LESSOR:

By: [Signature] for Mike Dero

By: [Signature]

Title: Purchasing Manager

Title: SVP SALES + CUSTOMER RELATIONS

Date: 6-24-08

Date: JUNE 16, 2008

APPROVED AS TO FORM:

LESSOR

By: _____

By: [Signature]

Title: Deputy County Counsel

Title: VP PROPERTY MANAGEMENT

Date: _____

Date: 6/17/08

*INSTRUCTIONS: If LESSOR is a corporation, including limited liability and non-profit corporations, the full legal name of the corporation shall be set forth above together with the signatures of two specified officers. If LESSOR is a partnership, the name of the partnership shall be set forth above together with the signature of a partner who has authority to execute this Agreement on behalf of the partnership. If LESSOR is contracting in an individual capacity, the individual shall set forth the name of the business, if any, and shall personally sign this Agreement.

Initials [Signature] [Signature]

Exhibit "A" to Wireless Communication Site Lease Agreement

SITE AND ACCESS AREA LEGAL DESCRIPTIONS

(The legal descriptions of the Site and Access are set forth in the Prime Lease attached to the Agreement as Exhibit "D" and is incorporated herein by reference.)

Wireless Site Lease Agreement – County of Monterey and Crown Castle MU LLC

Initials JS MS

Exhibit "B" to Wireless Communication Site Lease Agreement

APPROVED SITE ENGINEERING APPLICATION AND TOWER LEVEL DRAWING

(See attached)

Wireless Site Lease Agreement – County of Monterey and Crown Castle MU LLC

Initials

AS MS

RFI# 9795

Page 1 of 24



Customer Approved: Mar 03 2008

Application ID: 44400

Revision # 12 Submitted: Jun 29 2007

Submitted By: Tracy Howe

Original Submit Date: Jun 01 2007

Desired Install Date: Jun 12 2007

Reason for Application: Adding additional antennas to existing configuration

JDE Job Number 89909

Applications are subject to applicable Crown Castle engineering, regulatory, zoning/planning, and priority property-owner approval. Approval conditions may result in alternative requirements for type and/or placement of equipment. Approval conditions may also lead to additional or revised engineering analysis at Crown Castle discretion and upon consent of the customer.

Company Information

MLA: N/A
 Company: COUNTY OF MONTEREY
 Address: 1590 MOFFETT STREET IT/TELECOM DEPT.
 City/Town: SALINAS
 State: CA Postal Code: 93905
 Customer Job Number: N/A
 Customer Payment Reference: N/A
 Customer Site Name: N/A
 Customer Site Number: N/A

Site Information

Crown Castle Site Name: Bryant Canyon
 Crown Castle Site ID: 839198
 Crown Castle District: San Francisco
 Address: .5 Miles W of Bryant Canyon Road 3 Miles North of Metzger Road
 City/Town: Soledad
 State: CA Postal Code: 93960
 County: Monterey
 Latitude: 36° 27' 34.1" Longitude: -121° 17' 58.5"
 Structure Type: GUYED Structure Height: 189.8 ft

Legal Entity Information

Operating Legal Entity: N/A

Primary Contact: Dave Dalby Phone: 831-759-6916
 E-mail: dalbyd@co.monterey.ca.us Fax: N/A
 Address: 1590 Moffett Street, IT/Telecom Dept.
 City/Town: Salinas State: CA Postal Code: 93905
 RF Contact: Lee Hollingsworth Phone: 831-796-1463
 E-mail: hollingsworthle@co.monterey.ca.us

Service Information

Svc	Technology	EIRP (WATTS)	Std Frequency	Frequencies			
				Transmit		Receive	
				Start	Stop	Start	Stop
1	ISM	100.0		453.5	453.75	453.45	453.65
2	ISM	100.0		158.0	159.0	155.5	156.5
3	MW Link	60.0		5900.0	6800.0	5900.0	6800.0

Antenna Information

#	Fig.	C Line	Pos.	Elev	Azimuth	Mfg. / Model	Svc	Transmit Start	Transmit Stop	Receive Start	Receive Stop	Use	Orient	Status
1	10	A	85 ft	277		ANDREW PL6-59D	3	5900.0	6800.0	5900.0	6800.0	TX/RX	Mid-Mount	Proposed
2	10	A	123 ft	277		ANDREW PL6-59D	3	5900.0	6800.0	5900.0	6800.0	TX/RX	Mid-Mount	Proposed
3	10	B	85 ft	161		ANDREW PL6-59D	3	5900.0	6800.0	5900.0	6800.0	TX/RX	Mid-Mount	Proposed
4	10	B	123 ft	161		ANDREW PL6-59D	3	5900.0	6800.0	5900.0	6800.0	TX/RX	Mid-Mount	Proposed

#	Fig.	Pos.	Qty	Mfg.	Model	Length	Status
5	UEM	A	25 ft 150	PL6-59D KATHREIN CL6-450	1 453.5	453.75 453.45 453.65	TX/RX Mid-Mount Installed
6	UEM	A	174 ft 135	KATHREIN K523221	2 158.0	159.0 155.5 156.5	TX/RX Mid-Mount Installed
7	UEM	A	55 ft 285	KATHREIN CA7-410	1 453.5	453.75 453.45 453.65	TX/RX Mid-Mount Installed
8	UEM	B	25 ft 255	KATHREIN GPB-150N	2 158.0	159.0 155.5 156.5	TX/RX Mid-Mount Installed
9	UEM	B	174 ft 135	KATHREIN K523221	2 158.0	159.0 155.5 156.5	TX/RX Mid-Mount Installed

Feedline Information

#	Fig.	Pos.	Qty	Mfg.	Model	Length	Status
1	10	A	1	Primary: ANDREW Secondary: N/A	EW63	135.0 ft	Proposed
2	10	A	1	Primary: ANDREW Secondary: N/A	EW63	173.0 ft	Proposed
3	10	B	1	Primary: ANDREW Secondary: N/A	EW63	135.0 ft	Proposed
4	10	B	1	Primary: ANDREW Secondary: N/A	EW63	173.0 ft	Proposed
5	UEM	A	1	Primary: ANDREW Secondary: N/A	LDF4RN-50A	75.0 ft	Installed
6	UEM	A	0	Primary: N/A Secondary: N/A	N/A	N/A	N/A
7	UEM	A	1	Primary: ANDREW Secondary: N/A	LDF4P-50A	105.0 ft	Installed
8	UEM	B	1	Primary: ANDREW Secondary: N/A	LDF4-50A	75.0 ft	Installed
9	UEM	B	1	Primary: ANDREW Secondary: N/A	LDF4-50A	224.0 ft	Installed

Optional Component Information

#	Fig.	Pos.	Qty.	Type	Mfg.	Model	Elev. 1	Status1	Elev. 2	Status2
1	10	A	N/A	N/A	N/A	N/A	N/A	N/A	N/A	N/A
2	10	A	N/A	N/A	N/A	N/A	N/A	N/A	N/A	N/A
3	10	B	N/A	N/A	N/A	N/A	N/A	N/A	N/A	N/A
4	10	B	N/A	N/A	N/A	N/A	N/A	N/A	N/A	N/A
5	UEM	A	N/A	N/A	N/A	N/A	N/A	N/A	N/A	N/A
6	UEM	A	N/A	N/A	N/A	N/A	N/A	N/A	N/A	N/A
7	UEM	A	N/A	N/A	N/A	N/A	N/A	N/A	N/A	N/A
8	UEM	B	N/A	N/A	N/A	N/A	N/A	N/A	N/A	N/A
9	UEM	B	1	TMA	KATHREIN	860 10003	174.0 ft	Installed		

Building/Pad/Power Requirements

	Type	L	W	H	Power Requirements
Building Requirements					VAC 120 Phase Single Phase
New Building/Shelter	Inside Shelter	6 ft 0 in	1 ft 6 in	7 ft 0 in	Amps 20 Generator Requirements
Existing Building/Shelter Floor Space		2 ft 0 in	1 ft 5 in	7 ft 0 in	Generator Needed? No Size (kW) N/A
Building Identification		0			Leased Area & Pad Size Fuel Type N/A
Pad Requirements					Length Width Fuel Tank Size N/A
Required Leased Size		6 ft 0 in	1 ft 6 in	8 ft 0 in	Leased Area: N/A/N/A Manufacturer N/A
Pad Size		N/A	N/A	N/A	Pad Size: N/A/N/A Model N/A
					Battery Requirements
					Quantity 4
					Manufacturer Marathon Model M12V90FT

Number of Equipment Cabinets at time of Install 0

Comments/Additional Information

Comments:

The County of Monterey Telecom Group proposes to add (4) new MW dishes @ two centerlines. At 65' a 6' dish w/ an AZ of 277 degrees, and a 6' dish w/ an AZ 161 degrees is proposed. At 95' a 6' dish w/ an AZ 277 degrees, and a 6' dish w an AZ 161 degrees. The actual operating frequency will be between 5900 and 6800 MHz which will be determined at a later date. All azimuths for existing, and proposed equipment is reported in True North. Additional lease area in the shelter is required; two additional areas of 2' x 3' x 8' for a total of 2' wide x 9' long x 8' h (the existing is 2' x 3').

* * Indicates where Cut Sheet data has been entered.

NOTICE: Structural Analysis shall be performed in accordance with the current revision of the TIA/EIA 222 standard and applicable local building permit codes and standards. EME analysis shall be consistent with current revision of FCC/OSHA standard OETB 65. AM detuning, when required, will be performed to 47 CFR22.371. The customer is responsible for all analysis expenses. All construction drawings are subject to Crown Castle engineering approval prior to commencement of tower attachments and compound installations. Installation of equipment not conforming to approved drawings may violate the terms of the occupancy agreement and will be corrected at the customer's expense. Crown Castle International requires drawings for pre-construction approval and as built drawings for physical configuration validation to be submitted as unlocked AutoCAD files (Version 2000i preferred).

Appendix A - Antenna, Feedline, TME Specifications

Antenna Specifications

Quantity	Manufacturer	Model	Type	Height	Width	Depth	Weight	Flat Plate Area
2	KATHREIN	K523221	GRID DISH	52.0 IN	52.0 IN	26.5 IN	55.1 LBS	6.34 FT2
1	KATHREIN	GPB-150N	OMNI	16.6 IN	24.3 IN	24.3 IN	2.6 LBS	0.24 FT2
1	KATHREIN	CA7-410	YAGI	16.5 IN	1.85 IN	44.0 IN	6.5 LBS	0.63 FT2
1	KATHREIN	CL6-450	YAGI	17.0 IN	12.0 IN	29.0 IN	22.0 LBS	2.78 FT2
4	ANDREW	PL6-59D	MICROWAVE DISH	72.0 IN	72.0 IN	24.8 IN	143.0 LBS	28.27 FT2

Feedline Specifications

Quantity	Manufacturer	Model	Nominal Size	Nominal O.D.
2	ANDREW	LDF4-50A	1/2"	0.63 IN
1	ANDREW	LDF4P-50A	1/2	0.63 IN
1	ANDREW	LDF4RN-50A	1/2	0.63 IN
4	ANDREW	EW63	ELLIPTICAL	1.16 IN

Tower Mounted Equipment Specifications

Quantity	Manufacturer	Model	Weight	Dimensions			Frequency		Sail Area
				Length	Width	Height	Low	High	
1	KATHREIN	860 10003	2.425 LBS	3.346 IN	5.118 IN	5.905 IN	0.0 MHZ	0.0 MHZ	0.0 FT2

ORIENT		CUSTOMER	€	STATUS	ANTENNA	FEEDLINE	TOWER		TOWER		TOWER		TOWER	
NO	DESCRIPTION	MODEL	WGT	TECH	AZ	TX/RX	QTY	SIZE	QTY	TYPE	MFG	MODEL	WGT	TYPE
A	WD MONTEREY COUNTY CA 85	PROPOSED	PROPOSED	777	WR WR	TX/RX	1	EN83	1	EN83	0			
B	WD MONTEREY COUNTY CA 85	PROPOSED	PROPOSED	161	WR WR	TX/RX	1	EN83	1	EN83	0			

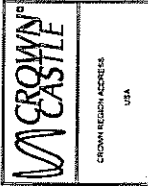

CROWN REGION ADDRESS
USA

SPACE RESERVED FOR PROFESSIONAL STAMP

NO.	DATE	DESCRIPTION	BY
1	12/15/11	REVISION 1	
2	12/15/11	REVISION 2	
3	12/15/11	REVISION 3	
4	12/15/11	REVISION 4	
5	12/15/11	REVISION 5	

DESIGNED BY: AM
CHECKED BY: SL
DRAWING DATE: 12/08/11

GITE NUMBER: _____
SITE NAME: _____
BRYANT CANTON: _____
BUSINESS UNIT NUMBER: _____

SITE COORDINATES: _____
2.5 MI W OF BRYANT CANYON ROAD 1 MI N OF _____
MONTEREY COUNTY
USA

SHEET TITLE: 85 FT LEVEL
SHEET NUMBER: _____

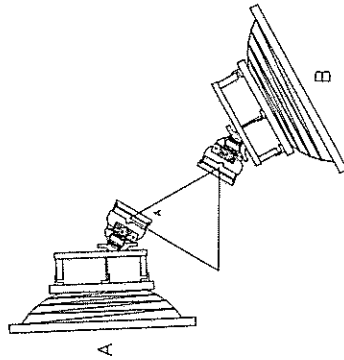

BUSINESS UNIT: 639158 TOWER ID: A LEVEL 85

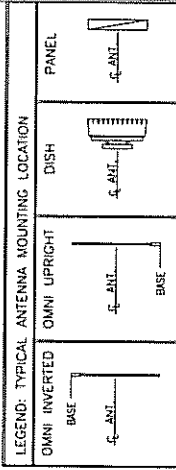

LEVEL DRAWING
PLOT DATE: 5/23/12 PLOT NAME: 231114_01.DWG

A1-3





CROWN CASTLE
CROWN REGION OFFICES
USA

SPACE RESERVED FOR PROFESSIONAL SEAL

NO	DATE	DESCRIPTION
1	11/08/03	REVISION Dwg. 20 FROM WORK ORDER # 18783
2	11/08/03	REVISION Dwg. 20 FROM WORK ORDER # 18783
3	11/08/03	REVISION Dwg. 20 FROM WORK ORDER # 18783

DESIGNED BY: AZ
CHECKED BY: ZL
DRAWING DATE: 12/26/07

SITE NUMBER: _____
SITE NAME: _____
SHEET NUMBER: _____
BUSINESS UNIT NUMBER: _____

3111 W OF BRYANT CANYON ROAD J B I N G
MONTEREY COUNTY
USA

123 FT LEVEL

SHEET NUMBER: _____

ORIENT		CUSTOMER	STATUS	MODEL	TECH	AZ	TX/RX	QTY	SIZE	TIME TYPE	MFG	MODEL
A	MD MONTEREY COUNTY CA 123	PROPOSED	AGSERN	P16-530	277	WK LNK	TX/RX 1	EN63	0			
B	MD MONTEREY COUNTY CA 123	PROPOSED	AGSERN	P16-530	181	WK LNK	TX/RX 1	EN63	0			

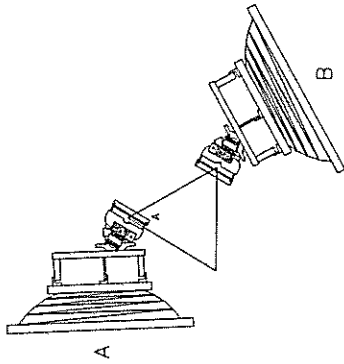
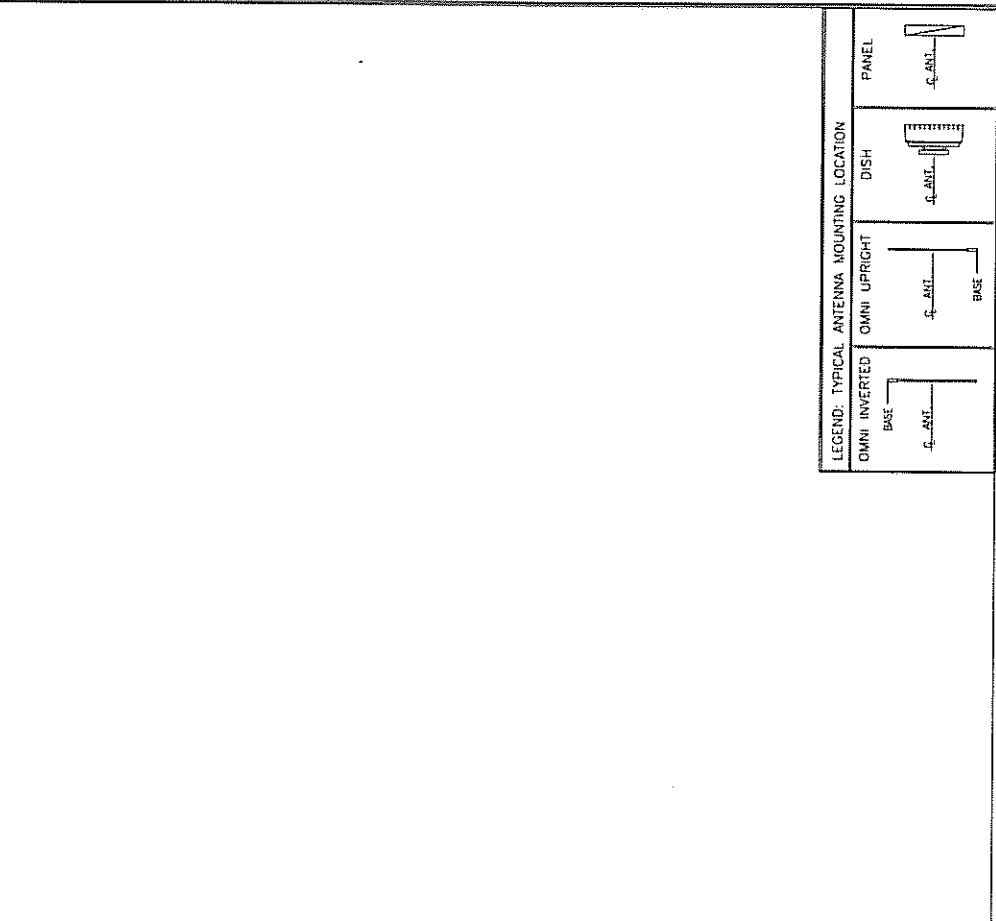

BUSINESS UNIT: B39109 TOWER ID: A LEVEL: 123

A1-2

LEVEL DRAWING
PLOT DATE: 5/22/08 FILE NAME: B39109_A_11.DWG

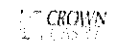

ORIENT		CUSTOMER		£	STATUS	ANTENNA		FEEDLINE		TOWER		MFG	
A	WD	MONTGOMERY COUNTY	CA	25	INSTALLED	ANTENNA	MFG	SIZE	QTY	TYPE	QTY	MFG	MODEL
						CP9-150B-N	25	1/2"	1	1/2"	0		
B	WD	MONTGOMERY COUNTY	CA	25	INSTALLED	ANTENNA	MFG	SIZE	QTY	TYPE	QTY	MFG	MODEL
						CP9-150B-N	25	1/2"	1	1/2"	0		

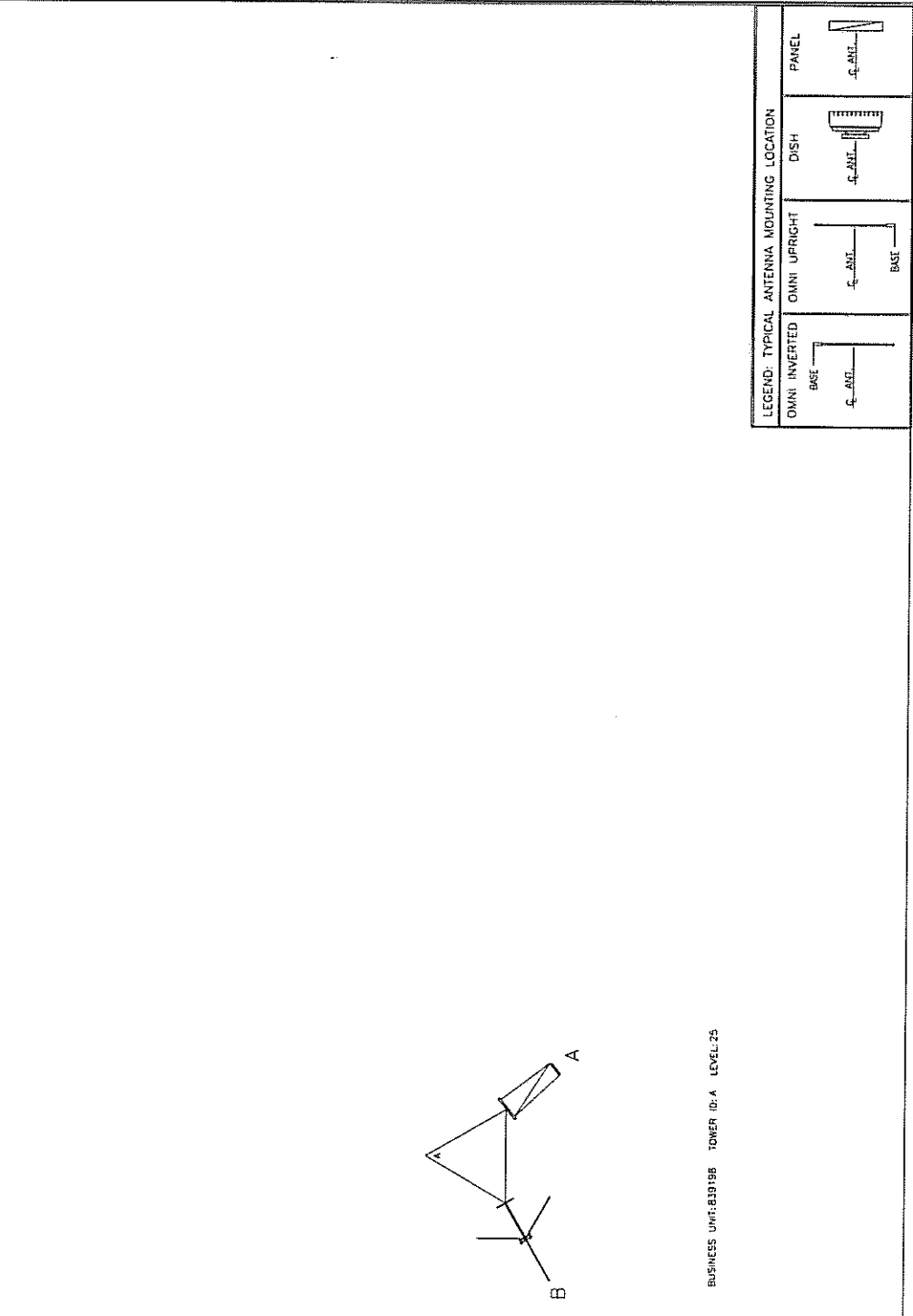

BUSINESS UNITS: 810198 TOWER ID: A LEVEL: 25

LEGEND: TYPICAL ANTENNA MOUNTING LOCATION

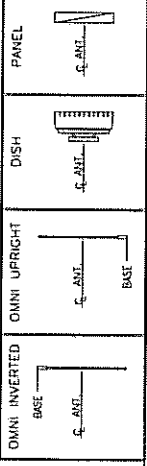

CROWN REGION ADDRESS
USA

SCALE: REFER TO PROFESSIONAL SCALE

NO.	DATE	DESCRIPTION
1	12/15/08	ISSUED FOR PERMITTING
2	12/15/08	ISSUED FOR PERMITTING
3	12/15/08	ISSUED FOR PERMITTING
4	12/15/08	ISSUED FOR PERMITTING
5	12/15/08	ISSUED FOR PERMITTING
6	12/15/08	ISSUED FOR PERMITTING
7	12/15/08	ISSUED FOR PERMITTING
8	12/15/08	ISSUED FOR PERMITTING
9	12/15/08	ISSUED FOR PERMITTING
10	12/15/08	ISSUED FOR PERMITTING

REVISIONS
 DRAWN BY: []
 CHECKED BY: []
 DATE: []
 COORDS: []
 SITE NUMBER: []
 SITE NAME: []
 SITE VALUE: []
 BRYANT CANYON
 BUSINESS UNIT NUMBER: []
 SITE ADDRESS: []
 5 MI W OF BRYANT CANYON ROAD 1 MI N OF []
 BAKERSFIELD CA 93309
 USA MONTGOMERY COUNTY
 SHEET TITLE: 25 FT LEVEL
 SHEET NUMBER: []

AI-5

LEVEL DRAWING
 PLOT DATE: 5/22/08 FILE NAME: 810198_A_31.DWG



ANTENNA		FEEDLINE				TIME							
ORFN	CUSTOMER	STATUS	MFG	MODEL	AZ	TECH	TV/RX	QTY	SIZE	QTY	TIME TYPE	MFG	MODEL
A	MONTEZ COUNTY CA 174	REPAIRED	KATHREN	K523221	135	GM	TV/RX 0	0		0			
B	MONTEZ COUNTY CA 174	INSTALLED	KATHREN	K523221	135	GM	TV/RX 1	1/2"		1	TMA	KATHREN	ESD 10001

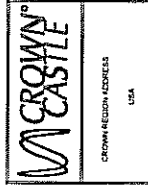

SPACE RESERVED FOR FURTHER DATA

NO.	DATE	DESCRIPTION
1	10/25/08	ISSUED FOR PER WORK ORDER # 108817
2	10/25/08	ISSUED FOR PER WORK ORDER # 108817
3	10/25/08	ISSUED FOR PER WORK ORDER # 108817
4	10/25/08	ISSUED FOR PER WORK ORDER # 108817
5	10/25/08	ISSUED FOR PER WORK ORDER # 108817
6	10/25/08	ISSUED FOR PER WORK ORDER # 108817
7	10/25/08	ISSUED FOR PER WORK ORDER # 108817
8	10/25/08	ISSUED FOR PER WORK ORDER # 108817
9	10/25/08	ISSUED FOR PER WORK ORDER # 108817
10	10/25/08	ISSUED FOR PER WORK ORDER # 108817

DRAWN BY: []
 CHECKED BY: []
 DRAWING DATE: []
 COLOR: []
 SITE NUMBER: []
 SITE NAME: []
 SITE NAME: []
 BUSINESS UNIT NUMBER: []
 BUSINESS UNIT NAME: []
 SITE ADDRESS: []
 5.1 MI W OF BRYANT CANYON ROAD 1 MI N OF []
 SOLIDAGO CO ARIZ []
 MONTEZ COUNTY []
 USA []
 SHEET TITLE: []
174 FT LEVEL
 SHEET NUMBER: []

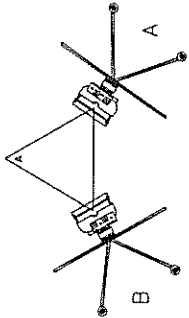

BUSINESS UNIT: 830196 TOWER ID: A LEVEL: 174

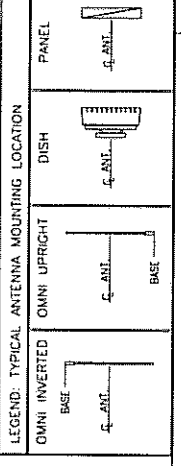

ORIENT		CUSTOMER		€	STATUS	ANTENNA		FEEDLINE		TWE	
NO	DIR	NAME	ADDRESS	TYPE	DATE	TYPE	TYPE	TYPE	TYPE	TYPE	TYPE
A	WD	MONTGOMERY COUNTY	CA	SS	INSTALLED	BARWREN	CAI-110	255	8U	1/2"	0

CARRIER LOGO



SPACE RESERVED FOR PROFESSIONAL SEAL

NO.	DATE	DESCRIPTION

DESIGNED BY: ATZ
 CHECKED BY: ATZ
 DRAWING DATE: 02/08/08

SHEET NUMBER: 1

SITE NUMBER: _____
 SITE NAME: _____
 SITE TIME: _____

BRYANT CANYON
 BUSINESS UNIT NUMBER: _____
 629118

SITE ADDRESS: _____
 5 MI W OF BRYANT CANYON ROAD 1 MI N OF
 BRYANT CANYON
 MONTGOMERY COUNTY
 USA

SHEET TITLE: 55 FT LEVEL
 SHEET NUMBER: _____

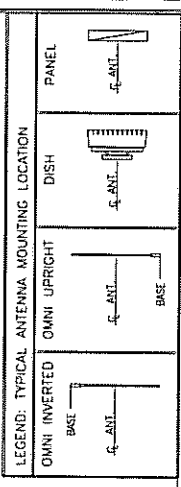
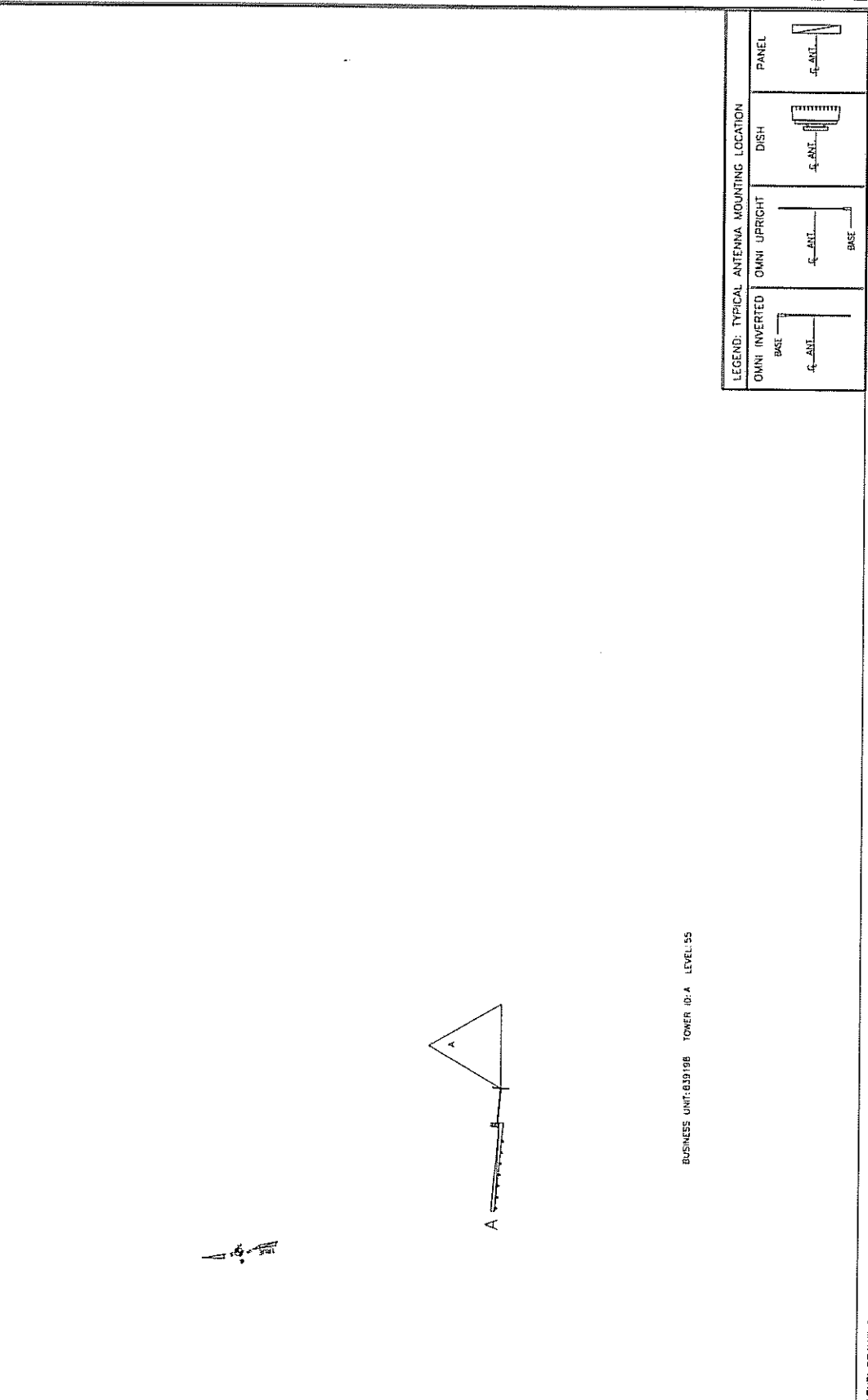

A1-4

LEVEL DRAWING

PLOT DATE: 02/20/08 PLOT NAME: 619118_A_01.DWG

CROWN

Exhibit "C" to Wireless Communication Site Lease Agreement

SITE PLAN; LOCATION AND DIMENSIONS (LENGTH, WIDTH, HEIGHT)
OF EQUIPMENT BUILDING/FLOOR SPACE
AND ANY OTHER INSTALLATION AT THE PROPERTY

(See attached)

JB *MS*

100'-0" (COMPOUND AREA)

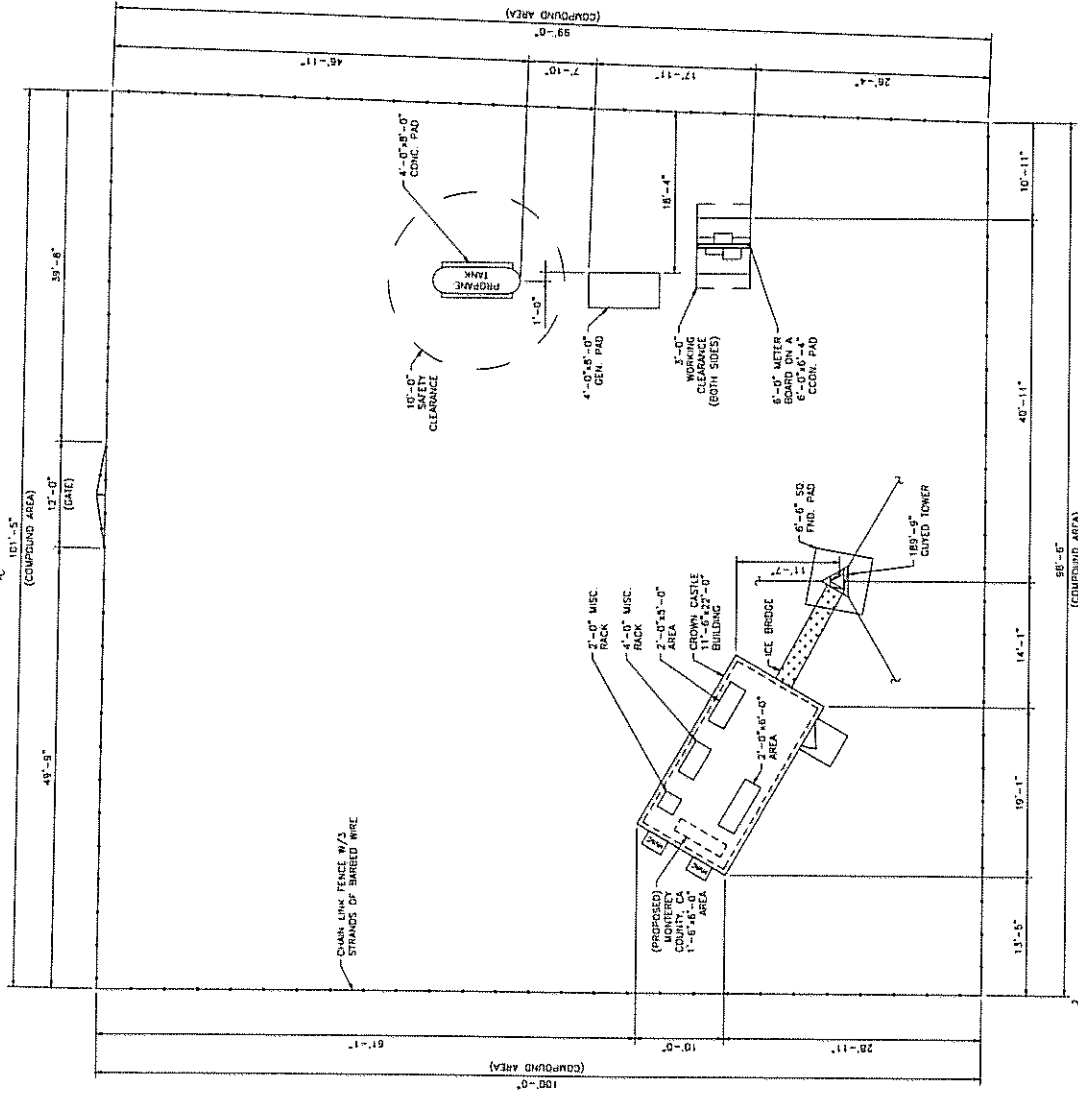
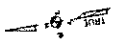

100'-0" (COMPOUND AREA)

101'-5" (COMPOUND AREA)

108'-0" (COMPOUND AREA)

BUSINESS UNIT: 033198

Exhibit "D" to Wireless Communication Site Lease Agreement

PRIME LEASE AGREEMENT

(See attached)

Wireless Site Lease Agreement – County of Monterey and Crown Castle MU LLC

Initials

BS NS

**JONES - MT. WILSON FM
TRANSMITTER SITE LEASE**

THIS TRANSMITTER SITE LEASE is entered into between William E. Jones, and Lewis C. Jones and Doris Jones, on the one hand (collectively referred to as "Landlord"), and Mt. Wilson FM Broadcasters, Inc., on the other hand (referred to as "Tenant"). The effective date of this Lease is September 1, 1997.

A. Premises. Landlord hereby leases, demises and lets to Tenant, and Tenant hereby leases, hires and takes from Landlord the following premises (the "Premises") described as follows:

1. Transmitter Site. The exclusive use to that certain 100' x 100' parcel for establishment of a radio tower antenna transmission site, located approximately on the parcel of real property shown as Assessor's Parcel No. 417-151-41 (which parcel is referred to herein as the "*Jones Parcel*"), and more particularly described as being located on Lots 9 and 16 of Section 10, and the East Half of the Northeast Quarter of Section 15, in

Township 17 South, Range 6 East of the Mount Diablo Meridian, geographic coordinates 36-27-36 by 121-17-53,- approximate unsurveyed location is shown on the map attached hereto as Exhibit A, and marked "Proposed Communications Site". The actual location will be the subject of survey, as provided herein.

2. Jones Road. A non-exclusive right of access over the Jones Road from Bryant Canyon Road to the Transmitter Site, as such road is described in the Transmitter Agreement to which this Lease is attached as an exhibit, with the exact location of such road to be established by survey as provided herein. The approximate unsurveyed location of such road is depicted on the map attached as Exhibit B hereto, as "Upper' Access Road" and "Old' Mt. Wilson Road".

3. Guy Wire/Anchor Placement. The exclusive right to place sufficient guy wires and anchors on the Jones Parcel outside

the Transmitter Site, as such guy wires and anchors may, from time to time, in the opinion of Tenant be necessary to safely anchor the antenna tower, together with sufficient space necessary to place an adequate fence around such guy anchors (estimated to be approximately 10' x 10' for each anchor), which approximate position as shown on the map attached hereto as Exhibit A, with the exact location of such wires and anchors to be established by survey as provided herein.

d. Power, Telephone and Utility Lines.

Tenant shall be given the right hereunder by Jones to take power, telephone and other utilities from the existing utility poles located on the utility easement shown of record against Assessor's Parcel Number 417-151-42, which easement was granted on October 14, 1993, and recorded in the Office of the Monterey County Recorder on October 29, 1993, as Document 76586, Reel 3017, page 115-120. All charges by the utilities

companies for hookups to such utilities, and the costs of installing physical connections from the easement to the Transmitter Site, shall be borne by Tenant.

B. Terms, Covenants and Conditions. The parties agree that this Lease is made upon the following terms, covenants and conditions:

1. Term. There shall be a five year base term, commencing upon the effective date of this lease. The monthly rent during the base term, beginning September 1, 1997, is as follows:

Year 1 -
Year 2 -
Year 3-5 -

2. Options to Extend Term. There shall be five (5) options to extend the term of the Lease, with each option for a term of five (5) years. Each option may be exercised by Tenant providing a written notice to Landlord of its intention to exercise the option, provided that such notice must be given within thirty (30) days of the end of the then current term.

3. Rent During Extended Terms.

a. Rent During First Extended Term. If the first five year option is exercised, the rent shall

be _____ per month during the first year of the extended term. The rent during the second through the fifth years of the first extended term shall be set as follows: Beginning on the second anniversary date of the first extended term, and on each anniversary date thereafter during the first extended term (Adjustment Date), Rent shall be increased by _____ of the percentage of increase, if any, shown by the Consumer Price Index for All Urban Consumers U.S. City Average, All Items (base years 1982-1984 = 100) (Index), published by the United States Department of Labor, Bureau of Labor Statistics, for the month immediately preceding the Adjustment Date as compared with the Index for the month immediately preceding the first day of the first extended term. Landlord shall calculate the amount of this increase in Base Rent after the United States Department of Labor publishes the statistics on which the amount of the increase

will be based. Landlord shall give written notice of the amount of the increase, multiplied by the number of installments of rent due under this Lease since the Adjustment Date. Tenant shall pay this amount, together with the monthly rent next becoming due under this Lease, and shall thereafter pay the monthly rent due under this Lease at this increased rate.

b. Rent During Additional Extended Terms.

If the second five year option (or any additional options) is/are exercised, the rent shall be

per month during the first year of the extended term for the second five year option.

The rent during the second through the fifth years of the second extended term, and for all years of any successive extended terms, shall be set as follows: Beginning on the second anniversary date of the second extended term, and on each anniversary date thereafter during the second extended term (Adjustment Date),

Rent shall be increased by

of the percentage of increase, if any, shown by the Consumer Price Index for All Urban Consumers U.S. City Average, All Items (base years 1982-1984 = 100) (Index), published by the United States Department of Labor, Bureau of Labor Statistics, for the month immediately preceding the Adjustment Date as compared with the Index for the month immediately preceding the second day of the first extended term. Landlord shall calculate the amount of this increase in Base Rent after the United States Department of Labor publishes the statistics on which the amount of the increase will be based. Landlord shall give written notice of the amount of the increase, multiplied by the number of installments of rent due under this Lease since the Adjustment Date. Tenant shall pay this amount, together with the monthly rent next becoming due under this Lease, and shall thereafter pay the monthly rent due under this Lease at this increased rate.

c. Changes in Index. If the Index is changed so that the base year differs from that in effect on the Adjustment Date, the Index shall be converted in accordance with the conversion factor published by the United States Department of Labor, Bureau of Labor Statistics. If the Index is discontinued or revised during the Lease Term (and any extended terms), the government index or computation with which it is replaced shall be used to obtain substantially the same result as if the Index had not been discontinued or revised.

4. Jones Road Maintenance. Jones shall be responsible for maintaining the Jones Road to the Transmitter Site in passable condition for four wheel drive vehicles. Mt. Wilson, at its option, may elect to maintain or improve the road at Mt. Wilson's expense, subject to the reasonable approval of Jones.

Jones reserves the right to relocate the Jones Road at their sole expense, provided that: (a) that Mt. Wilson is given equivalent or better access to the Transmitter Site; (b) that the relocated road easement is properly surveyed by Jones and made an addendum to this Lease; (c) and that the relocated easement imposes no additional burdens on Mt. Wilson.

5. **Condition Precedent.** The enforceability of this lease is expressly conditioned upon the successful completion of the terms of the Transmitter Agreement, to which this Lease is attached, and which terms are incorporated herein by this reference.

6. **Assignment and Subletting.** Tenant shall have the right to sublet or assign its rights hereunder. In this regard, Landlord acknowledges that it is tenant's intent to develop the transmitter site for use by a number of different users, involving transmitters, and receivers, and communications equipment of different types and purposes.

7. **Survey.** Tenant, at Tenant's expense, shall cause the Premises to be surveyed. Such survey, when complete, shall be attached to this lease as an exhibit.

C. **Closing Recitals.**

1. **Freely and Voluntarily Entered Into.** This lease is freely and voluntarily executed by each party, without duress of any sort, after having been apprised of all relevant information and data and all other information relevant to this agreement. Landlord acknowledge that this agreement has been drafted by Duffy & Guenther, the attorneys for Tenant, and that the Landlord have been given the opportunity to have this agreement reviewed by separate counsel.
2. **Authority to Enter Into Agreement.** Each person executing this

lease warrants and represents that (s)he has full authority to enter into this transaction on behalf of the parties shown.

3. **Merger/Integration Clause.** This lease, along with the Transmitter Agreement and its exhibits constitute the sole understanding of the parties. All other agreements, representations, warranties, promises or understandings, whether oral or written, are merged into this lease and the Transmitter Agreement and its exhibits. Any modification to this lease must be in writing and signed by the parties to be affected.
4. **Venue for Disputes/Applicable Law.** In the event of any litigation between the parties arising from this lease, the parties stipulate that such litigation shall be conducted in Monterey County, that venue is appropriate in such forum, and that the laws of the State of California shall be used to interpret this lease.
5. **Counterparts.** This lease may be executed in counterparts. Facsimile signatures shall be deemed to be as effective as originals for the purposes of this agreement. In the event of signature by counterparts, the lease shall be deemed complete when the signed counterparts of the lease have been received by Thomas R. Duffy, Esq., the attorney for Tenant.
 - (1) Landlord has been advised to have this document reviewed by its own attorney. -Each party represents to the other that

before signing this document, each party has carefully read and reviewed each term of this document.

- 6. Interpretation of the Agreement. The language in all parts of this lease shall be construed according to its fair meaning and not strictly for or against any party hereto, regardless of who may be perceived to have drafted the document.
- 7. Severability. If any provision of this lease is held to be illegal, invalid or unenforceable under present or future laws, such provision shall be fully severable.
- 8. Attorney's Fees. If either party takes action, including arbitration, to enforce or interpret any provision of this agreement, the prevailing party shall be entitled to reasonable attorney's fees and costs, including fees and costs of expert witnesses, in addition to any other relief granted.

AGREED:

Lewis E. Jones
 Lewis E. Jones, Landlord

Doris Jones
 Doris Jones, Landlord

William E. Jones 9-2-97
 William E. Jones, Landlord

Saul Levine
 Saul Levine, President of
 Mt. Wilson FM Broadcasters, Inc., Tenant

TRANSMITTER SITE EASEMENT
(SEE REEL 2005-09-134)

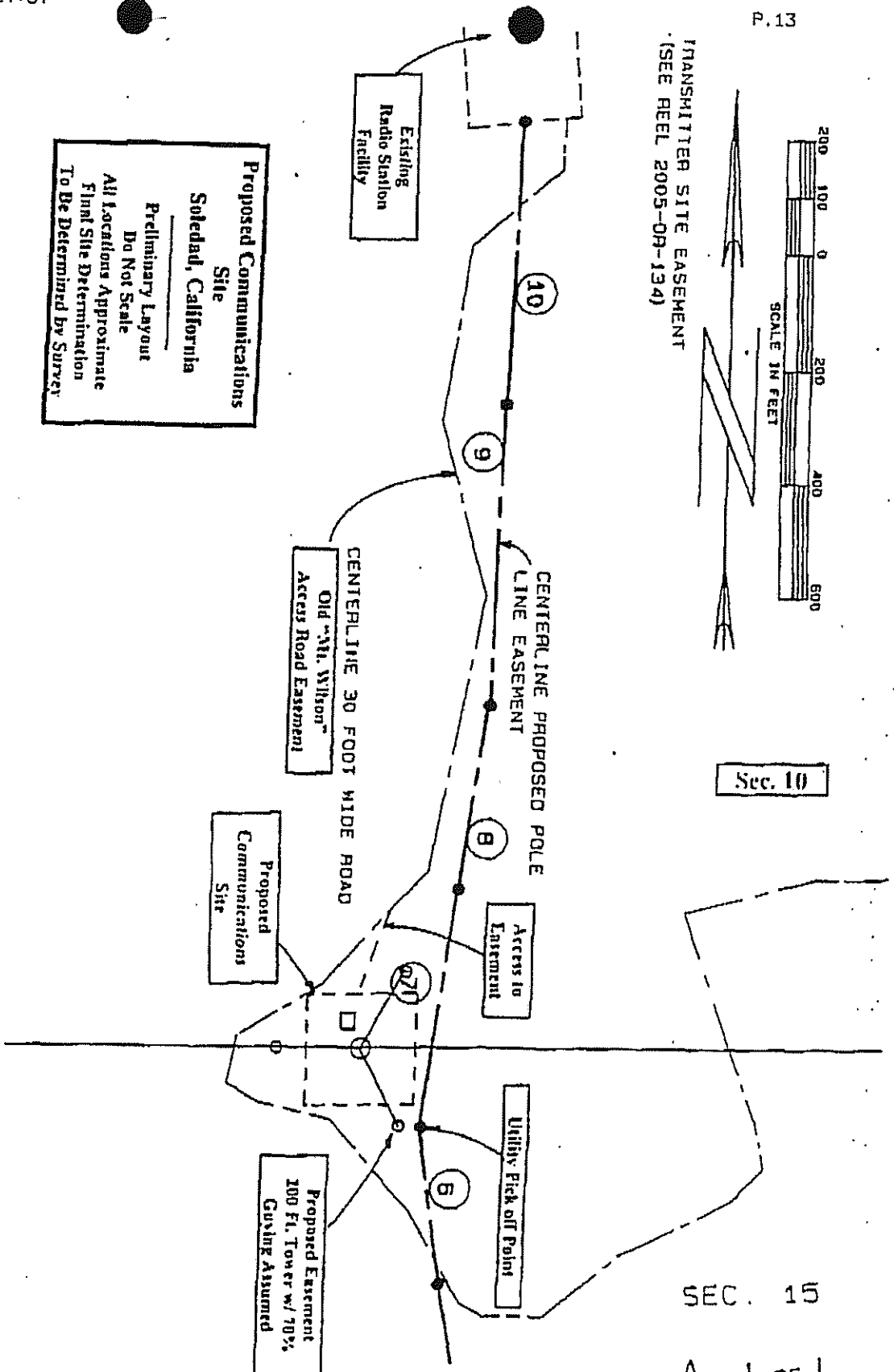
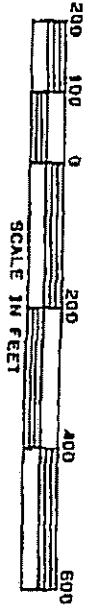

Proposed Communications Site
Soledad, California
 Preliminary Layout
 Do Not Scale
 All Locations Approximate
 Final Site Determination
 To Be Determined by Survey

EXHIBIT A P. 1 OF 1

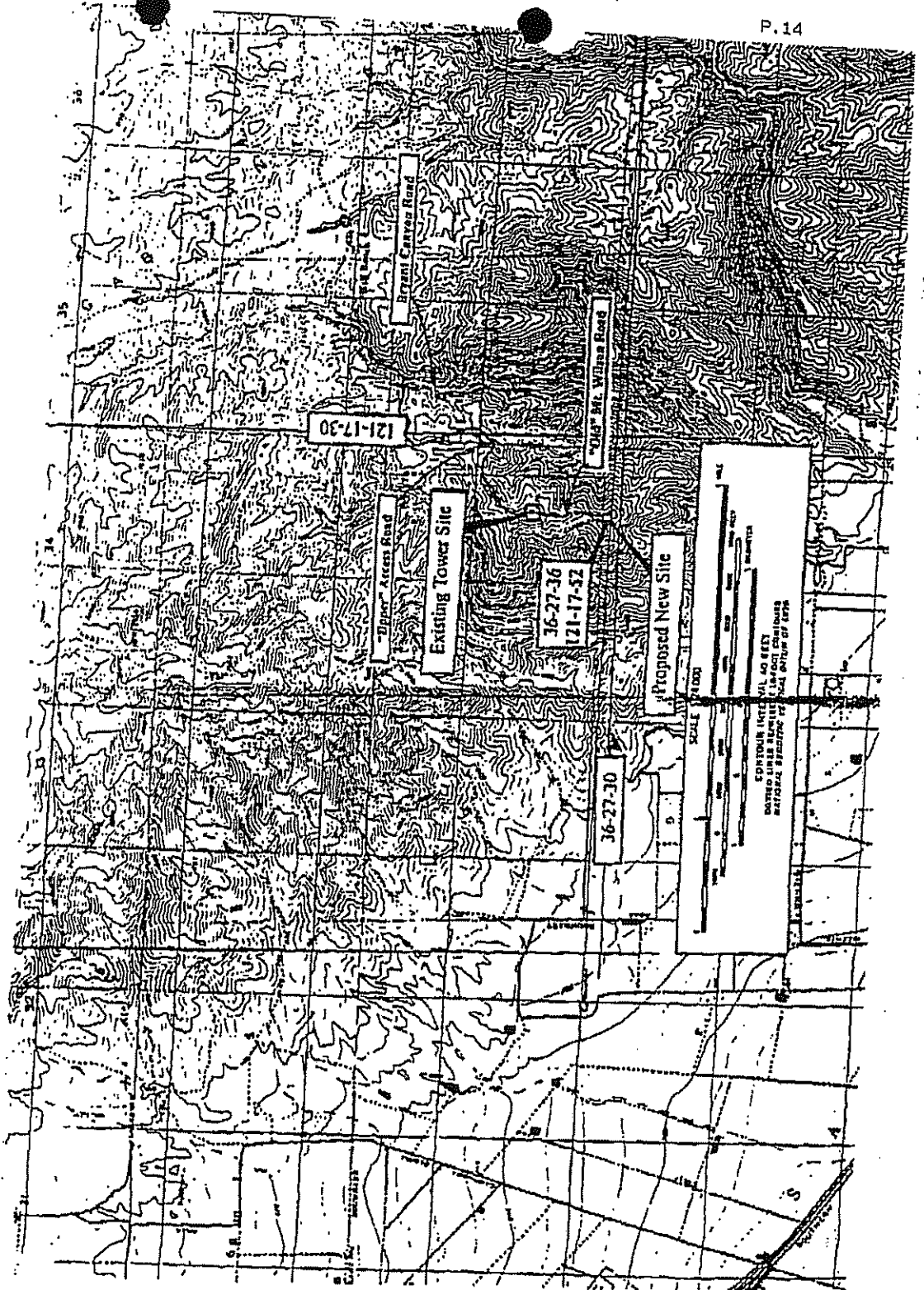

EXHIBIT B P. 1 OF 1

TOTAL P.14

RECORDING REQUESTED BY

AND WHEN RECORDED MAIL TO:

Mountain Union Telecom, LLC
301 N. Fairfax Street, Suite #101
Alexandria, VA 22314

(space above for Recorder's use only)

7/19/02 - w

MEMORANDUM OF LEASE AND TRANSMITTER AGREEMENT

THIS MEMORANDUM OF LEASE AND TRANSMITTER AGREEMENT (this "Memorandum"), is made and entered into as of this first day of January, 2001 by and between William E. Jones, in his individual capacity, and Lewis C. Jones and Doris Jones as Trustees of the Lewis Jones and Doris Jones Trust U/D/T February 25, 1999 (collectively, "Jones" or "Lessor" herein) and Mountain Union Telecom, LLC, a Delaware limited liability company ("Mountain Union" or "Lessee" herein). This Memorandum is a record of that certain Transmitter Site Lease effective as of September 1, 1997 by and between Lessor and Mt. Wilson FM Broadcasters, Inc. ("Mt. Wilson"), Mountain Union's predecessor-in-interest (the "Lease"). This Memorandum is also a record of that certain Transmitter Agreement effective as of September 1, 1997, as amended by that certain First Amendment to Transmitter Agreement effective as of June 1, 1999 by and between Jones and Mt. Wilson as Mountain Union's predecessor-in-interest (the "Transmitter Agreement"). The Lease and the Transmitter Agreement are collectively referred to herein as the "Documents."

Amendment

The Documents include a number of provisions including, without limitation, the following:

1. Description of Premises. The Documents pertain to those certain premises hereinafter referred to as the "Leased Premises." The Leased Premises are described on Exhibit "A", which exhibit is attached hereto and incorporated herein by this reference. Lessor has also granted to Lessee, for Lessee's use and enjoyment of the Leased Premises, the exclusive pole line easement, exclusive ingress/egress/roadway easement, and the non-exclusive ingress/egress/roadway easement described in Exhibit A.
2. Term. The Initial Term of the Lease commenced on September 1, 1997 and terminates on August 31, 2002.
3. Option to Renew. Lessee has the option to extend the term of the Lease for five (5) successive terms, each of which is five (5) years in duration.
4. Subletting. Lessee has the right, at any time during the term of the Lease, to assign or sublet any of its rights under the Lease and to permit any portion of the Leased Premises to be occupied or used by subtenants, licensees or customers in connection with the provision of wireless communication services.
5. Restatement of Lease and Transmitter Agreement. By this Memorandum, the parties intend to record a reference to the Lease and Transmitter Agreement and do hereby ratify and confirm all of the terms and conditions of the Documents and declare that the Leased Premises are subject to all of the applicable provisions of the Documents.

IN WITNESS WHEREOF, Jones and Mountain Union have executed this Memorandum as of the date first above written.

JONES

MOUNTAIN UNION TELECOM, LLC

By: William E. Jones
William E. Jones

By: David E. Weisman
David E. Weisman

By: Lewis C. Jones
Lewis C. Jones, Trustee of the
Lewis Jones and Doris Jones Trust U/D/T 2/25/99

President and Chief Executive Officer

By: Doris Jones
Doris Jones Trustee of the
Lewis Jones and Doris Jones Trust U/D/T 2/25/99

(Initials) ME Date 7/31/02 BUN 839198
Doc ID DYAT Doc Type L
Lessor License # 601245
C. Anthon

EXHIBIT A
LEGAL DESCRIPTION OF LEASED PREMISES

(See attached.)

PROPERTY DESCRIPTION

WILLIAM E. JONES, et al, to:

Certain real property situate in the northeast quarter (NE 1/4) of Section 15, the east half (E 1/2) of Section 10, and the northwest quarter (NW 1/4) of Section 11, Township 17 South, Range 6 East, Mount Diablo Meridian, County of Monterey, State of California, according to the official plat thereof, being a portion of those certain tracts of land described in the "Grant Deed" from William E. Jones, et al, to William E. Jones, et al, dated August 20, 1997 and recorded October 8, 1997 (Document No. 9758627), records of said county, said portion being more particularly described as follows:

FIRST:

AN EXCLUSIVE TRANSMITTER SITE LEASE for communication transmission purposes including, but not limited to, the installation and maintenance of transmission facilities and appurtenances thereto, beginning at a point from which a 2 inch by 2 inch stake standing at the east one-quarter corner (E 1/4) of said Section 15 bears South 21° 58' 52" East, 2,806.83 feet distant, said point of beginning being herein and now designated as Point "B" for the reference thereto in future description hereinafter to be made; thence

- 1) North 71° 00' West, 100.00 feet; thence
- 2) North 19° 00' East, 100.00 feet; thence
- 3) South 71° 00' East, 100.00 feet, at 40.51 feet a point herein and now designated as Point "C" for the reference thereto in future description hereinafter to be made, 100.00 feet; thence
- 4) South 19° 00' West, 100.00 feet to the point of beginning.

Containing an area of 10,000 square feet of land, more or less.

SECOND:

AN EXCLUSIVE EASEMENT for pole line purposes and the transmission of electricity including ingress and egress to and from, and appurtenances thereto 10 feet wide, lying 5 feet equally on each side of the following described centerline:

Beginning at the hereinbefore mentioned Point "B" and running thence:

- 1) South $32^{\circ} 47' 44''$ East, 128.39 feet, more or less, to an existing power pole.

The sidelines of the easement described above shall be lengthened or shortened as necessary to terminate on the boundaries of the exclusive transmitter site easement described under "First" above.

THIRD:

AN EXCLUSIVE EASEMENT for ingress, egress, and roadway purposes, along, over, upon, and across a strip of land 30 feet wide, lying 15.00 feet equally on each side of the following described centerline:

Beginning at the hereinbefore mentioned Point "C" and running thence; along an existing traveled roadway

- 1) North $22^{\circ} 57'$ East, 235.04 feet, more or less, to an angle point in an existing 30-foot wide right-of-way, said angle point being the northerly terminus of that certain course numbered 42 (North $42^{\circ} 43' 44''$ East, 269.80 feet) in Exhibit "B" under "First", in the "Grant of Easement" from Neta Adams, Trustee of the Aurelia M. Jones Trust U/A September 27, 1983 and October 4, 1983 to Mount Wilson FM Broadcasters, Inc., dated April 11, 1986 and recorded in Reel 2005 of Official Records at Page 134 and following, records of said county.

The sidelines of the easement described above shall be lengthened or shortened as necessary to terminate on the boundaries of the exclusive transmitter site easement described under "First" above and the southeasterly line of the existing 30-foot wide easement described in the hereinbefore mentioned "Grant of Easement" described in Reel 2005 of Official Records at Page 134 and following, records of said county.

FOURTH:

A NON-EXCLUSIVE EASEMENT for ingress, egress, and roadway purposes, along, over, upon, and across a strip of land 30 feet wide, lying 15.00 feet equally on each side of the following described centerline:

Beginning at a point designated Point "A", standing on the southerly boundary of an existing transmitter site easement and the northerly terminus of the centerline of a 30-foot wide right-of-way, said transmitter site easement and 30-foot wide right-of-way being described under Exhibit "B" in the "Grant of Easement" from Neta Adams, Trustee of the Aurelia M. Jones Trust U/A September 27, 1983 and October 4, 1983 to Mount Wilson FM Broadcasters, Inc., dated April 11, 1986 and recorded on Reel 2005 of Official Records at Page 134 and following, record of said county; thence, from said point of beginning (Point "A"), running along an existing traveled roadway

- 1) North 21° 16' 17" West, 190.77 feet; thence
- 2) North 37° 37' 24" West, 97.48 feet; thence
- 3) North 14° 00' 00" West, 204.00 feet; thence
- 4) North 32° 20' 12" East, 505.10 feet; thence
- 5) North 63° 23' 59" East, 434.82 feet; thence
- 6) North 37° 52' 50" East, 227.46 feet; thence
- 7) North 67° 41' 01" East, 205.81 feet; thence
- 8) South 80° 07' 38" East, 219.68 feet; thence
- 9) North 85° 19' 23" East, 140.29 feet; thence
- 10) South 52° 08' 48" East, 223.09 feet; thence
- 11) South 86° 58' 36" East, 176.46 feet; thence
- 12) North 57° 18' 41" East, 236.75 feet; thence

- 13) North 20° 57' 54" East, 290.37 feet; thence
- 14) North 12° 03' 16" East, 171.68 feet; thence
- 15) North 21° 27' 21" West, 480.44 feet; thence
- 16) North 4° 19' 17" West, 183.04 feet; thence
- 17) North 22° 28' 39" West, 164.03 feet; thence
- 18) North 31° 16' 36" West, 123.80 feet; thence
- 19) North 18° 32' 35" West, 330.98 feet; thence
- 20) North 18° 08' 26" East, 121.12 feet; thence
- 21) North 45° 58' 00" East, 260.30 feet; thence
- 22) South 79° 37' 35" East, 337.64 feet; thence
- 23) North 33° 00' 00" East, 179.00 feet; thence
- 24) North 26° 06' 10" East, 113.50 feet; thence
- 25) North 89° 00' 33" East, 133.44 feet; thence
- 26) South 60° 50' 32" East, 173.61 feet; thence
- 27) South 79° 18' 23" East, 168.97 feet; thence
- 28) North 88° 46' 01" East, 83.58 feet; thence
- 29) North 59° 53' 11" East, 187.40 feet, more or less, to the centerline of Bryant Canyon Road (a 40-foot wide county road - as traveled).

The sidelines of the 30-foot wide roadway easement described above shall be lengthened or shortened to form a vertex and to terminate on the easterly line of Bryant Canyon Road (a county road) and the southerly line of the hereinbefore mentioned transmitter site easement.

SUBJECT TO, HOWEVER, the rights of the County of Monterey, in and to all that portion thereof lying within the limits of Bryant Canyon Road (a county road).

COURSES ALL TRUE. (Bearings used herein are based on the meridian shown on that certain Map filed in Volume 6 of Parcel Maps at Page 138, records of Monterey County, California.)

This description was prepared under my
direction.

Philip L. Pearman

Philip L. Pearman, L.S. 4448

License expires 9/30/01

October 28, 1997

END OF DESCRIPTION

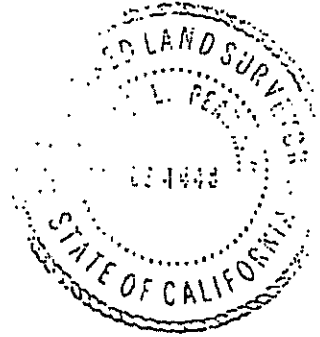

STATE OF CALIFORNIA)

) ss.

COUNTY OF Monterey)

On 1-22, 2001 before me, RENO E. BRESCHINI, Notary Public, personally appeared William E. Jones, personally known to me (or proved to me on the basis of satisfactory evidence) to be the person whose name is subscribed to the within instrument and acknowledged to me that he executed the same in his authorized capacity, and that by his signature on the instrument the person, or the entity upon behalf of which the person acted, executed the instrument.

WITNESS my hand and official seal.

Reno E. Breschini

STATE OF CALIFORNIA)

) ss.

COUNTY OF Monterey

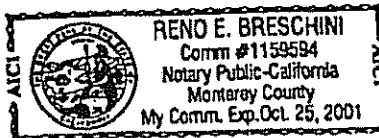

On 1-22, 2001 before me, RENO E. BRESCHINI, Notary Public, personally appeared Lewis C. Jones, personally known to me (or proved to me on the basis of satisfactory evidence) to be the person whose name is subscribed to the within instrument and acknowledged to me that he executed the same in his authorized capacity, and that by his signature on the instrument the person, or the entity upon behalf of which the person acted, executed the instrument.

WITNESS my hand and official seal.

Reno E. Breschini

STATE OF CALIFORNIA)

) ss.

COUNTY OF Monterey)

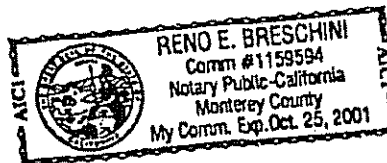

On 1-22, 2001 before me, RENO E. BRESCHINI, Notary Public, personally appeared Doris Jones, personally known to me (or proved to me on the basis of satisfactory evidence) to be the person whose name is subscribed to the within instrument and acknowledged to me that he executed the same in his authorized capacity, and that by his signature on the instrument the person, or the entity upon behalf of which the person acted, executed the instrument.

WITNESS my hand and official seal.

Reno E. Breschini

STATE OF VIRGINIA)

) ss.

COUNTY OF Alexandria)

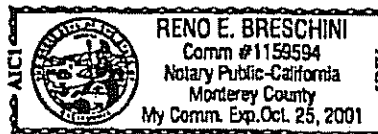

On Jan 16 2001 before me, Cristina Bridges, Notary Public, personally appeared David E. Weisman, personally known to me (or proved to me on the basis of satisfactory evidence) to be the person whose name is subscribed to the within instrument and acknowledged to me that he executed the same in his authorized capacity, and that by his signature on the instrument the person, or the entity upon behalf of which the person acted, executed the instrument.

WITNESS my hand and official seal.

Cristina Bridges

MY COMMISSION EXPIRES
NOVEMBER 30, 2001

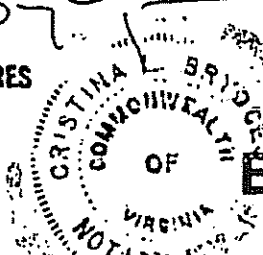

END OF DOCUMENT

Exhibit "E" to Wireless Communication Site Lease Agreement

SITE RULES

Crown Castle International

**2000 Corporate Drive
Canonsburg, PA 15317**

Rev/Issue Date Business Owner

Revision	CCI Corporate Engineering
10.2	
3/28/05	

SITE RULES

This document and its contents are the confidential and proprietary property of Crown Castle International (hereinafter Crown), and are furnished to you on the following conditions. No right or license in respect of this document or its contents is given or waived in supplying the document to you. This document or its contents are not to be used or treated in any manner inconsistent with the rights of Crown, or to its detriment and are not to be copied, reproduced, disclosed to others, or disposed of except with prior written consent of Crown.

Revision History

Rev	Description of Change	Date	Approved
-	Initial Release	1/5/05	
9.0	Revised	2/1/05	
10.0	Revised	2/22/05	
10.1	Corrected Date For Engineering Services SOW	3/7/05	
10.2	Corrected Header and Footer	3/28/05	

JB *MS*

SITE RULES

I. GENERAL

A. PURPOSE

Except to the extent otherwise agreed in writing, these Site Rules govern the use of all wireless communications sites (collectively, the "Sites"; each individually, a "Site") owned, operated, managed or leased by Crown Castle USA, Inc. and/or its affiliates (collectively, and each individually, "Crown Castle").

B. CONFORMITY WITH NATIONAL, STATE AND LOCAL CODES AND REGULATIONS AND CROWN CASTLE STANDARDS

All installations shall conform to all national, state and local codes and regulations and Crown Castle standards ("Crown Castle Standards"), including but not limited to the following:

1. American National Standards Institute, Telecommunications Industry Association, Electronic Industries Association Standards set forth in ANSI/TIA/EIA-222-(latest revision). (Structural Standards for Steel Antenna Towers and Antenna Supporting Structures.)
2. Federal Aviation Administration, Department of Transportation Rules and Regulations, including 14 C.F.R. §§ 77.1-77.75 (regarding Objects Affecting Navigable Airspace) and Advisory Circular AC 70/7460-1 (most current edition).
3. Federal Communications Commission Rules and Regulations, including 47 C.F.R. §§ 17.1-17.58 and 47 C.F.R. § 1.1307(b).
4. National Fire Protection Association Codes, including the following:
 - a) Code 54 (National Fuel Gas Code) Code 58 (LP Gas Code);
 - b) Code 70 (National Electrical Code);
 - c) Code 90A (Installation of Air Conditioning and Ventilating Systems);
 - d) Code 90B (Installation of Warm Air Heating and Air Conditioning Systems);
 - e) Code 101 (Life Safety);
 - f) Code 110 (Emergency and Standby Power Systems);
 - g) Code 780 (Lightning Protection); and
 - h) Code 70E (Standard for Electrical Safety in the Workplace).
5. Applicable State and Local Building and Fire Safety Codes; such as BOCA (Building Officials and Code Administrators Int'l.), ICBO (Int'l. Conference of Building Officials), SBCCI (Southern Building Code Congress Int'l.), I/UBC (Int'l./Uniform Building Code), NFPA 5000 (National Fire Protection Association Code 5000).
6. Occupational Safety and Health Administration, Department of Labor Rules and Regulations regarding Safety and Health Standards, including 29 C.F.R. § 1910.268 (Special Industries - Telecommunications) and 29 C.F.R. § 1926.501 (Fall Prevention).

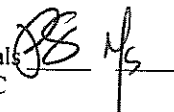

7. EPA Regulations: 42 U.S.C. § 11022 Hazardous Chemical Inventory.
8. The following Crown Castle Standards which are available from Crown Castle (Sharepoint files):
 - a) Structural Analysis SOW (REV G 3/5/05);
 - b) CCUSA A & E Standards (REV 0: 3/18/04);
 - c) CCUSA Construction Standards Details (REV 0: 3/18/04);
 - d) CCUSA Contractor Closeout Package Requirements (REV 4: 12/15/04);
 - e) CCUSA Cutting & Welding Policy (REV 2.2: 2/18/04) and Welding Guidelines (REV 2.3: 2/18/04);
 - f) CCUSA Grounding Details (REV 0: 3/18/04);
 - g) CCUSA Ground Resistance Testing Procedure (Megtest) (See Closeout Requirements) (REV 4.0: 12/14/04); and
 - h) Site Clearance & Work Space for LPG (REV 0: 7/7/04).

II. SITE ACCESS AND ELEVATED WORK

- A. Copies of all construction and building permits must be provided to Crown Castle.
- B. No children or animals shall be permitted at any Site at any time.
- C. Any person performing Elevated Work at any Site must be fully aware of and knowledgeable about the inherent dangers of RF exposure and climbing or working above ground level, especially with regard to tower structures. Individuals who climb tower structures at Sites must have received adequate RF exposure training and fall safety training acceptable to Crown Castle. For the purposes of this Section II(C), "Elevated Work" means any work that is performed over six feet (6') above ground level.

III. RADIO FREQUENCY INTERFERENCE ISSUES

- A. Any cabinet or coaxial cable RF energy leakage which causes interference to other users of the Site shall be immediately corrected by the owner of such equipment.
- B. Questions regarding intermodulation protection should be directed to the attention of: Crown Castle USA Inc., EMC Engineer, telephone: (724) 416-2000.

IV. SITE HOUSEKEEPING

- A. Equipment shelter doors will be kept closed at all times.
- B. All trash, dirt, debris and other materials brought onto any Site must be removed when exiting the Site.
- C. No food or drink is permitted in any Crown Castle equipment shelter.
- D. Smoking is not permitted inside any Crown Castle equipment shelter.
- E. Doorways, vestibules and other areas in and around a Site will not be obstructed or used for any purpose other than the intended purpose.

- F. All construction materials must be maintained in a neat and orderly manner.
- G. Except as otherwise set forth herein, no signs, advertisements, graphics or notices (except for warning signs placed in or around a Site by Crown Castle) shall be placed in or around a Site.
- H. Warning signs placed on or around Sites by Crown Castle shall not be disturbed.
- I. No equipment parts or materials will be stored at a Site unless such equipment parts or materials are stored within the subject party's equipment building.

V. REPORTING DAMAGE; EMERGENCY NUMBERS; ACCESS TO CROWN CASTLE EQUIPMENT SHELTERS

- A. Any person that observes any release of diesel fuel or any damage to any structure, component or equipment at a Site, whether or not such release or damage was caused by such person, shall promptly report such release or damage to Crown Castle by notifying Crown Castle's "NOC" at 1-800-788-7011. In addition, any injuries experienced at a site requiring medical attention must be reported to the Crown Castle "NOC" at 1-800-788-7011.
- B. Emergency twenty-four (24) hour contact number(s) must be displayed on the outside of all equipment cabinets and buildings located on Sites.
- C. Routine service of any equipment installed in a Crown Castle equipment shelter shall be scheduled with Crown Castle between the hours of 8:00 a.m. and 5:00 p.m. weekdays.
- D. Access cards shall be used to prevent activation of the alarm system when entering any Crown Castle equipment shelter equipped with a security access system. The security system shall be re-armed when the equipment shelter is exited.
- E. Except in the event of an emergency, any person accessing any Crown Castle equipment shelter after 10:00 p.m. must give Crown Castle's "NOC" prior notification of such access by calling 1-800-788-7011.

VI. CONSTRUCTION

- A. All construction involving changes to physical structures or foundations at Sites, including, without limitation, all construction involving tower erection, tower reinforcement, monopole porthole installation, and guy tensioning shall be performed in accordance with these Site Rules and the subject plans and specifications.
- B. The scheduling of all construction shall be coordinated with Crown Castle to allow Crown Castle, at its option, to have a representative present at the subject Site during the performance of the work. All installation, repair and maintenance of equipment at Sites shall be performed in accordance with standard engineering practices, these Site Rules and the subject plans and specifications.
- C. Except as otherwise agreed by Crown Castle in writing, no alterations or physical additions in or to a Site shall be made without Crown Castle's prior written permission except as permitted by the applicable Master License Agreement.

- D. Movement of any construction vehicles, equipment buildings, generators and similarly large equipment in or around a Site shall be restricted to times designated by Crown Castle. Crown Castle shall determine the method of routing such equipment to ensure the safety of all concerned parties and to minimize any damage to the Site and to any equipment or other property at the Site. Advance notice of at least seventy-two (72) hours shall be provided to Crown Castle prior to the movement of any such equipment. Crown Castle shall determine the manner in which such equipment will be placed at the Site and the maximum amount of such equipment allowed in any area of a Site.

VII. BIRD'S NESTS

- A. No work may be done on a tower at a Site where there is an active nest of a protected species of bird, including threatened or endangered species and birds of prey without prior consultation with, and written permission from, Crown Castle's Regulatory Department. Inactive nests may not be removed without prior consultation with, and written permission from, Crown Castle's Regulatory Department.
- B. Crown Castle's "NOC" shall be notified of any nest discovered on a tower at a Site by calling 1-800-788-7011.

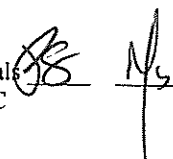

Exhibit "F" to Wireless Communication Site Lease Agreement

FORM OF MEMORANDUM OF AGREEMENT

(See attached)

Wireless Site Lease Agreement – County of Monterey and Crown Castle MU LLC

Initials

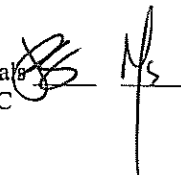

EXHIBIT A

DESCRIPTION OF LAND

Page ___ of ___

to the Memorandum of Lease dated _____, 200__, by and between the _____ as "Lessor" and County of Monterey, a political subdivision of the State of California as "Lessee".

The Land is described and/or depicted as follows:

[Note#1: County Recorders require a written legal description of the Property or Premises. A site plan drawing is not sufficient. Please be sure to include a written description of the Property obtained from the deed.]

[Note#2: County Recorders require that all text be at least 10 pt. font. Please make sure all exhibits and all text on this page is 10 pt. font or larger.]

and otherwise known as:

APN:

Notes:

1. This Exhibit may be replaced by a land survey and/or construction drawings of the Premises once received by Tenant.
2. Any setback of the Premises from the Property's boundaries shall be the distance required by the applicable governmental authorities.
3. Width of access road shall be the width required by the applicable governmental authorities, including police and fire departments.
4. The type, number and mounting positions and locations of antennas and transmission lines are illustrative only. Actual types, numbers and mounting positions may vary from what is shown above.

<p>Recording Requested By: <i>County of Monterey</i> <i>Public Works</i> <i>Real Property Specialist</i> <i>855 E. Laurel Drive, Building C</i> <i>Salinas, CA 93905</i></p> <p>And When Recorded Return to: <i>County of Monterey</i> <i>Public Works</i> <i>Real Property Specialist</i> <i>855 E. Laurel Drive, Building C</i> <i>Salinas, CA 93905</i></p> <p>APN: _____</p>	
--	--

Space Above This Line For Recorder's Use Only

Re: Site # _____; Cell Site Name: _____
 State: California
 County: Monterey

**MEMORANDUM
 OF
 LEASE**

This Memorandum of Lease is entered into on this ____ day of _____, 200__, by and between _____, (hereinafter referred to as "Lessor") and County of Monterey, a political subdivision of the State of California, (hereinafter referred to as "Lessee").

1. Lessor and Lessee entered into a certain Lease Agreement ("Agreement") on the ____ day of _____, 200__, for the purpose of installing, operating and maintaining a communications facility and other improvements. All of the foregoing are set forth in the Agreement.
2. The term of the Agreement is for five (5) years commencing on _____, 200__ with three (3) successive five (5) year options to renew.
3. The Land which is the subject to the Agreement is described in Exhibit A annexed hereto.

IN WITNESS WHEREOF, the parties have executed this Memorandum of Agreement as of the day and year first above written.

LESSOR

LESSEE:

By: _____
 Name:
 Title:
 Date: _____

County of Monterey
 By: _____
 Name: _____
 Title: Purchasing Manager
 Date: _____
 Approved As To Form

By: _____
 Title: _____
 Date: _____

By: _____
 Title: _____
 Date: _____

[ACKNOWLEDGEMENTS APPEAR ON NEXT PAGE]

