

# Attachment C

This page intentionally left blank.

SHEET NUMBER	TOTAL SHEETS
1	8

# COUNTY OF MONTEREY

## PROJECT PLANS FOR THE CONSTRUCTION OF THE ELKHORN RD / WERNER RD / SALINAS RD INTERSECTION SAFETY IMPROVEMENT - PHASE I

### COUNTY PROJECT No. 1166

**SHEET INDEX:**

	SHEET No.	TITLE
T1 - T2	1	TITLE SHEET
L1 - L2	2-3	LAYOUT
PD1 - PD2	4-5	PAVEMENT DELINIATION
S1 - SQ1	6-8	SIGN PLAN AND QUANTITIES

**ABBREVIATIONS:**

BC	-	BEGINNING OF CURVE
EC	-	END OF CURVE
PCC	-	POINT OF COMPOUND CURVATURE
Beg	-	BEGIN
BB	-	BUFFERED BIKE LANE



UNDERGROUND FACILITIES SHOWN WERE LOCATED BASED ON INFORMATION PROVIDED BY UTILITY COMPANIES AND BY MEASURING SURFACE FEATURES.

CONTRACTOR SHALL VERIFY ACTUAL DEPTH AND LOCATION OF ALL EXISTING UTILITIES PRIOR TO CONSTRUCTION...CALL "UNDERGROUND SERVICE ALERT" (U.S.A), (TOLL FREE 811) PRIOR TO TRENCHING, GRADING, EXCAVATION, DRILLING, PIPE PUSHING, PLANTING TREES, DIGGING POST HOLES FOR FENCE, ETC.(U.S.A) WILL SUPPLY INFORMATION OR LOCATE AND MARK ANY UNDERGROUND FACILITIES.

**GENERAL NOTES:**

1. THE CONTRACTOR SHALL POSSESS THE CLASS (OR CLASSES) OF LICENSE AS SPECIFIED IN THE "NOTICE TO BIDDERS".

APPROVED BY MONTEREY COUNTY

BY ACTION OF THE BOARD OF SUPERVISORS	
APPROVED ON _____	
PER BOARD ORDER NO. _____	
_____ CARL P. HOLM	_____ DATE
RESOURCE MANAGEMENT AGENCY DIRECTOR	

Submitted by: J. WALTER Design Engineer C.E. No. 41227	
DESIGN BY: E. SAMAY	CHKD BY:
DRAWN BY: E. SAMAY	CHKD BY: J. VANEGAS-MORAN
SPECIFICATIONS WRITTEN BY: J. WALTER	CHKD BY: J. WALTER
Approval Recommended by: _____ Deputy Public Works Director, Engineering	



669 Pacific Street, Suite A  
San Luis Obispo, CA 93401 USA  
T 1 805 242 0461 W www.ghd.com



NO.	DATE	REVISION DESCRIPTION	APPROVED



**COUNTY OF MONTEREY**  
RESOURCE MGMT. AGENCY,  
DEPT. OF PUBLIC WORKS

168 WEST ALISAL STREET  
SALINAS, CALIFORNIA 93901  
(831) 755-4800/FAX (831) 755-4958

<b>ELKHORN RD / WERNER RD / SALINAS RD INTERSECTION SAFETY IMPROVEMENT - PHASE I</b>			
<b>TITLE</b>			
DATE 07/13/2020	FILE	PROJECT NO. 11145015	SHEET T1
SCALE 1"=250'		CONTRACT NO.	

Drawing name: C:\P\0\2569\Salinas\_Road\_Dist\_P&S\25691001.dwg Layout: Tab: T1 Jul 13 2020 - 3:13pm Invent2

LEGEND

TYPE 2 SLURRY SEAL

SHEET NUMBER	TOTAL SHEETS
2	8

LINE DATA		
NO.	Δ	L
L1	N58°07'29"E	1525.23'
L2	N78°52'31"E	463.47'

CURVE DATA				
NO.	R	Δ	T	L
C1	1500.00'	020°45'02"	274.63'	543.25'
C2	1075.00'	032°09'23"	309.84'	603.33'

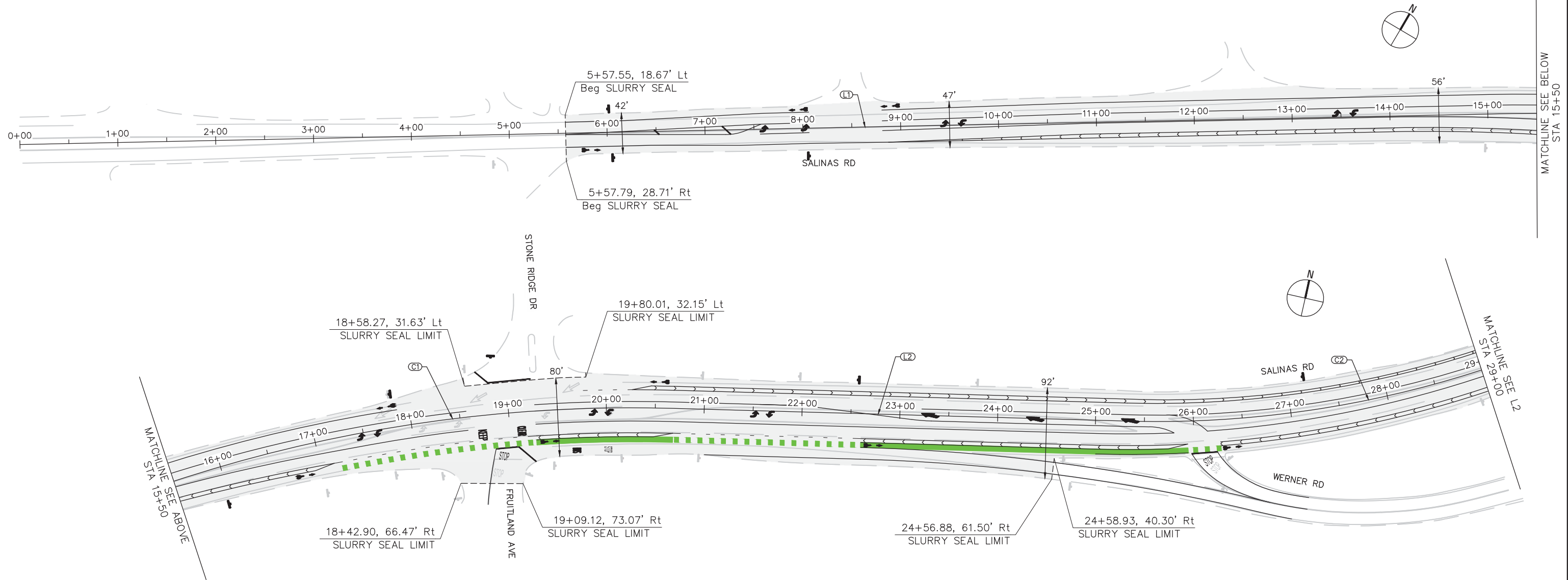

Drawing Name: C:\PWS\2500\Salinas Road - Blk\_PWS\2500\001.dwg Layout: Tab: L1 Jul 13 2020 - 11:47:00 jmw02

Submitted by: J. WALTER Design Engineer C.E. No. 41227	
DESIGN BY: E. SAMAY	CHKD BY:
DRAWN BY: E. SAMAY	CHKD BY: J. VANEGAS-MORAN
SPECIFICATIONS WRITTEN BY: J. WALTER	CHKD BY: J. WALTER
Approval Recommended by: Deputy Public Works Director, Engineering	

**GHD**  
669 Pacific Street, Suite A  
San Luis Obispo, CA 93401 USA  
T 1 805 242 0461 W www.ghd.com



NO.	DATE	REVISION DESCRIPTION	APPROVED

**COUNTY OF MONTEREY**  
RESOURCE MGMT. AGENCY,  
DEPT. OF PUBLIC WORKS  
168 WEST ALISAL STREET  
SALINAS, CALIFORNIA 93901  
(831) 755-4800/FAX (831) 755-4958

ELKHORN RD / WERNER RD / SALINAS RD INTERSECTION SAFETY IMPROVEMENT - PHASE I LAYOUT SHEET			
DATE 07/13/2020	FILE	PROJECT NO. 11145015	SHEET L1
SCALE 1"=50'		CONTRACT NO.	

LINE DATA		
NO.	Δ	L
L3	N27°28'31"E	6.62'
L4	N00°19'43"E	112.33'

CURVE DATA				
NO.	R	Δ	T	L
C2	1075.00'	032°09'23"	309.84'	603.33'
C3	1350.00'	019°14'36"	228.86'	453.41'
C4	2200.00'	027°08'48"	531.15'	1042.36'

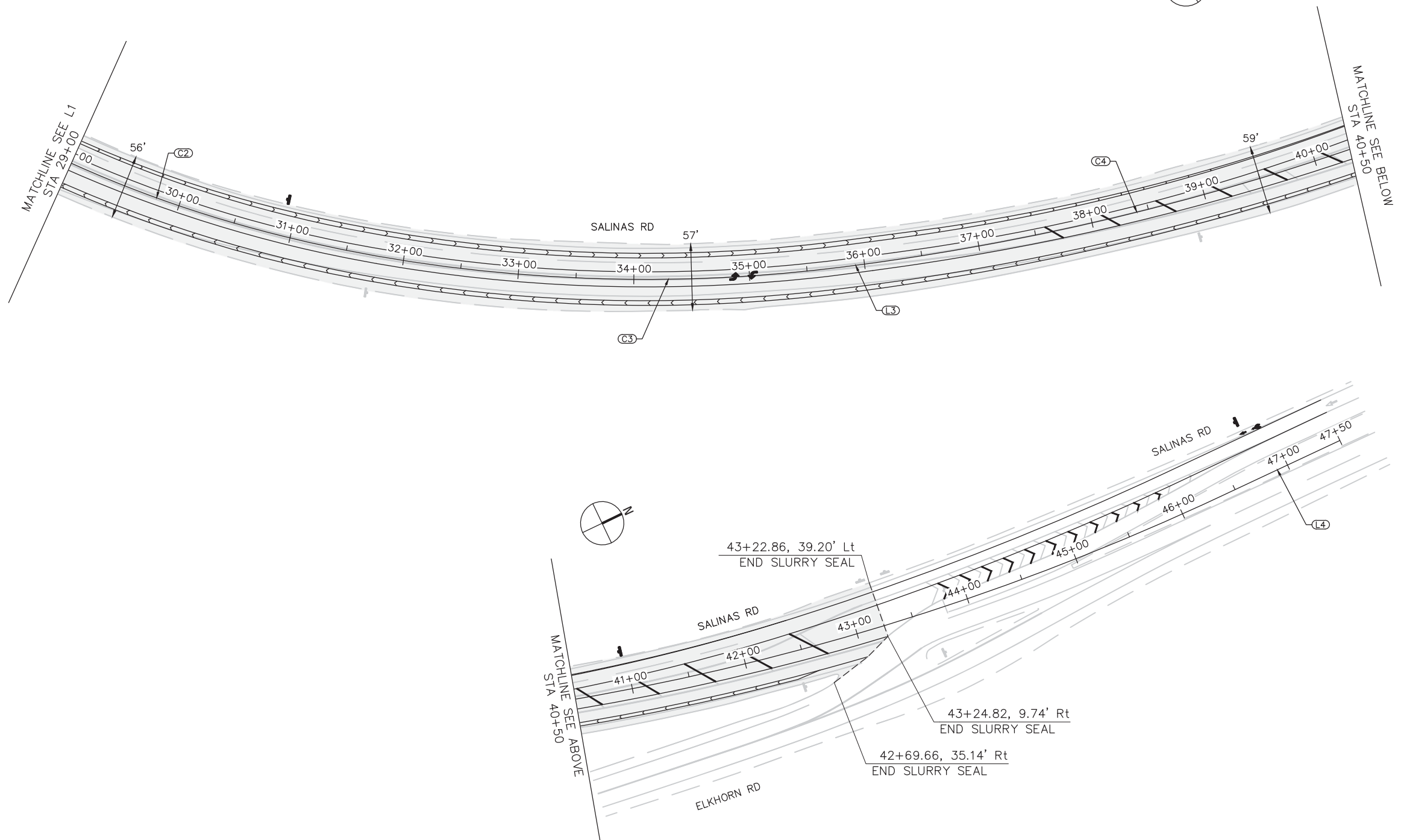

Drawing Name: C:\P\0\2589\Salinas Road - Blk. P\2589\2589L001.dwg Layout: Tab: L2 Jul 13 2020 - 11:47:00 jmw2

Submitted by: J. WALTER Design Engineer C.E. No. 41227	
DESIGN BY: E. SAMAY	CHKD BY:
DRAWN BY: E. SAMAY	CHKD BY: J. VANEGAS-MORAN
SPECIFICATIONS WRITTEN BY: J. WALTER	CHKD BY: J. WALTER
Approval Recommended by: Deputy Public Works Director, Engineering	

**GHD**  
669 Pacific Street, Suite A  
San Luis Obispo, CA 93401 USA  
T 1 805 242 0461 W www.ghd.com



NO.	DATE	REVISION DESCRIPTION	APPROVED

**COUNTY OF MONTEREY**  
RESOURCE MGMT. AGENCY,  
DEPT. OF PUBLIC WORKS  
168 WEST ALISAL STREET  
SALINAS, CALIFORNIA 93901  
(831) 755-4800/FAX (831) 755-4958

ELKHORN RD / WERNER RD / SALINAS RD INTERSECTION SAFETY IMPROVEMENT - PHASE I LAYOUT SHEET			
DATE 07/13/2020	FILE	PROJECT NO. 11145015	SHEET L2
SCALE 1"=50'		CONTRACT NO.	

**LEGEND**

- STRIPING DETAIL NUMBER PER STATE STANDARD PLANS
- 12' THERMOPLASTIC PAVEMENT MARKING, (LIMIT LINE)
- BUFFERED BIKE LANE (SEE DETAIL)
- 4' BIKE LANE BLOCKS (SEE DETAIL)
- 8" WHITE THERMOPLASTIC PAVEMENT MARKING, 50' SPACED DIAGONAL HATCH
- 8" WHITE THERMOPLASTIC PAVEMENT MARKING, 20' SPACED CHEVRON MARKING
- GREEN PAVEMENT MARKING (SKID RESISTANT SURFACE)
- LIMIT OF STRIPING PATTERN
- CHANGE IN STRIPING PATTERN
- TANGENT POINT
- ANGLE POINT
- "STOP" THERMOPLASTIC PAVEMENT MARKING
- "BIKE LANE" THERMOPLASTIC PAVEMENT MARKING
- TYPE VI ARROW THERMOPLASTIC PAVEMENT MARKING
- TYPE IV (L) ARROW THERMOPLASTIC PAVEMENT MARKING
- "BUS STOP" THERMOPLASTIC PAVEMENT MARKING
- "KEEP CLEAR" THERMOPLASTIC PAVEMENT MARKING

**NOTES**

1. ALL THERMOPLASTIC TRAFFIC STRIPES AND PAVEMENT MARKINGS SHALL BE SKID RESISTANT AND CONFORM TO THE LATEST EDITION OF CA MUTCD AND THE 2018 STATE STANDARD PLANS.
2. REMOVE ALL CONFLICTING STRIPING AND MARKINGS PRIOR TO PLACING FINAL PAVEMENT DELINEATION.

**ABBREVIATIONS**

- Beg - BEGIN
- BB - BUFFERED BIKEWAY
- BC - BEGIN CURVE
- EC - END CURVE
- PCC - POINT OF COMPOUND CURVATURE

SHEET NUMBER	TOTAL SHEETS
4	8

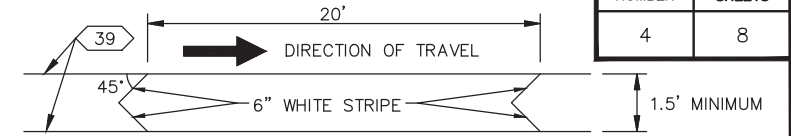

**BUFFERED BIKE LANE DETAIL**  
NO SCALE

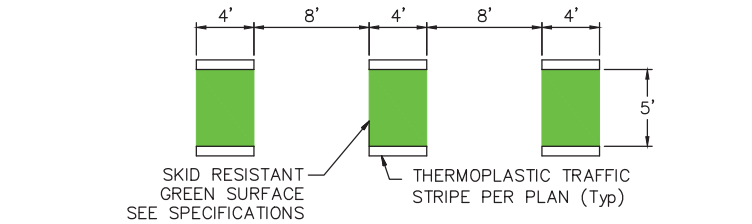

**BIKE LANE GREEN BLOCKS**  
NO SCALE

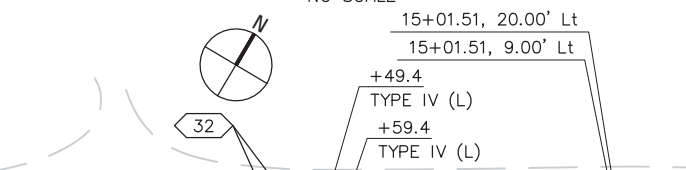

CURVE DATA				
NO.	R	Δ	T	L
C1	1500.00'	020°45'02"	274.63'	543.25'
C2	1075.00'	032°09'23"	309.84'	603.33'

LINE DATA		
NO.	Δ	L
L1	N58°07'29"E	1525.23'
L2	N78°52'31"E	463.47'

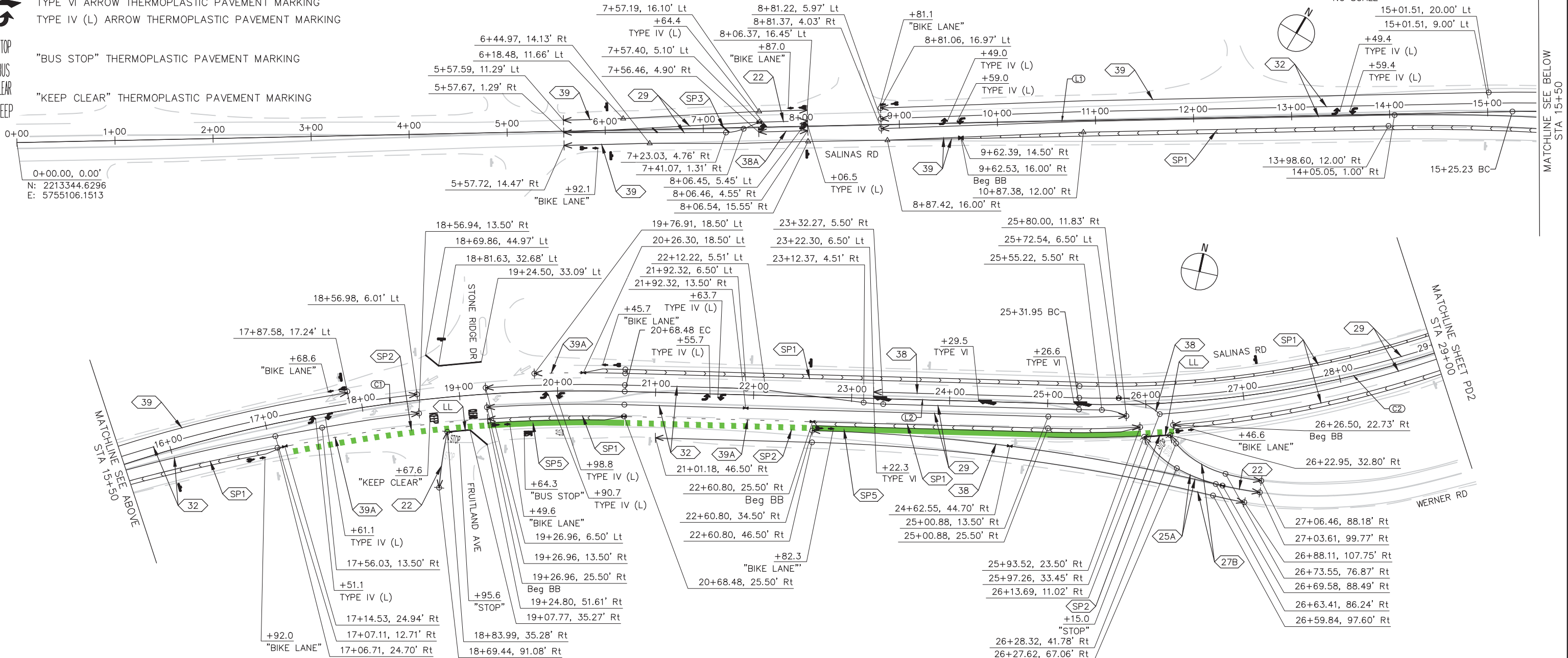

Drawing Name: C:\PWS\2508\Salinas Road Det. PWS\2508P1001.dwg Layout Tab: PD1 Jul 13 2020 - 11:48am jmw02

Submitted by: J. WALTER Design Engineer C.E. No. 41227	
DESIGN BY: E. SAMAY	CHKD BY:
DRAWN BY: E. SAMAY	CHKD BY: J. VANEGAS-MORAN
SPECIFICATIONS WRITTEN BY: J. WALTER	CHKD BY: J. WALTER
Approval Recommended by: Deputy Public Works Director, Engineering	

**GHD**  
669 Pacific Street, Suite A  
San Luis Obispo, CA 93401 USA  
T 1 805 242 0461 W www.ghd.com



NO.	DATE	REVISION DESCRIPTION	APPROVED

**COUNTY OF MONTEREY**  
RESOURCE MGMT. AGENCY,  
DEPT. OF PUBLIC WORKS

168 WEST ALISAL STREET  
SALINAS, CALIFORNIA 93901  
(831) 755-4800/FAX (831) 755-4958

ELKHORN RD / WERNER RD / SALINAS RD INTERSECTION SAFETY IMPROVEMENT - PHASE I			
<b>PAVEMENT DELINEATION</b>			
DATE 07/13/2020	FILE	PROJECT NO. 11145015	SHEET PD1
SCALE 1"=50'		CONTRACT NO.	

SHEET NUMBER	TOTAL SHEETS
5	8

CURVE DATA				
NO.	R	Δ	T	L
C2	1075.00'	032°09'23"	309.84'	603.33'
C3	1350.00'	019°14'36"	228.86'	453.41'
C4	2200.00'	027°08'48"	531.15'	1042.36'

LINE DATA		
NO.	Δ	L
L3	N27°28'31"E	6.62'
L4	N00°19'43"E	112.33'

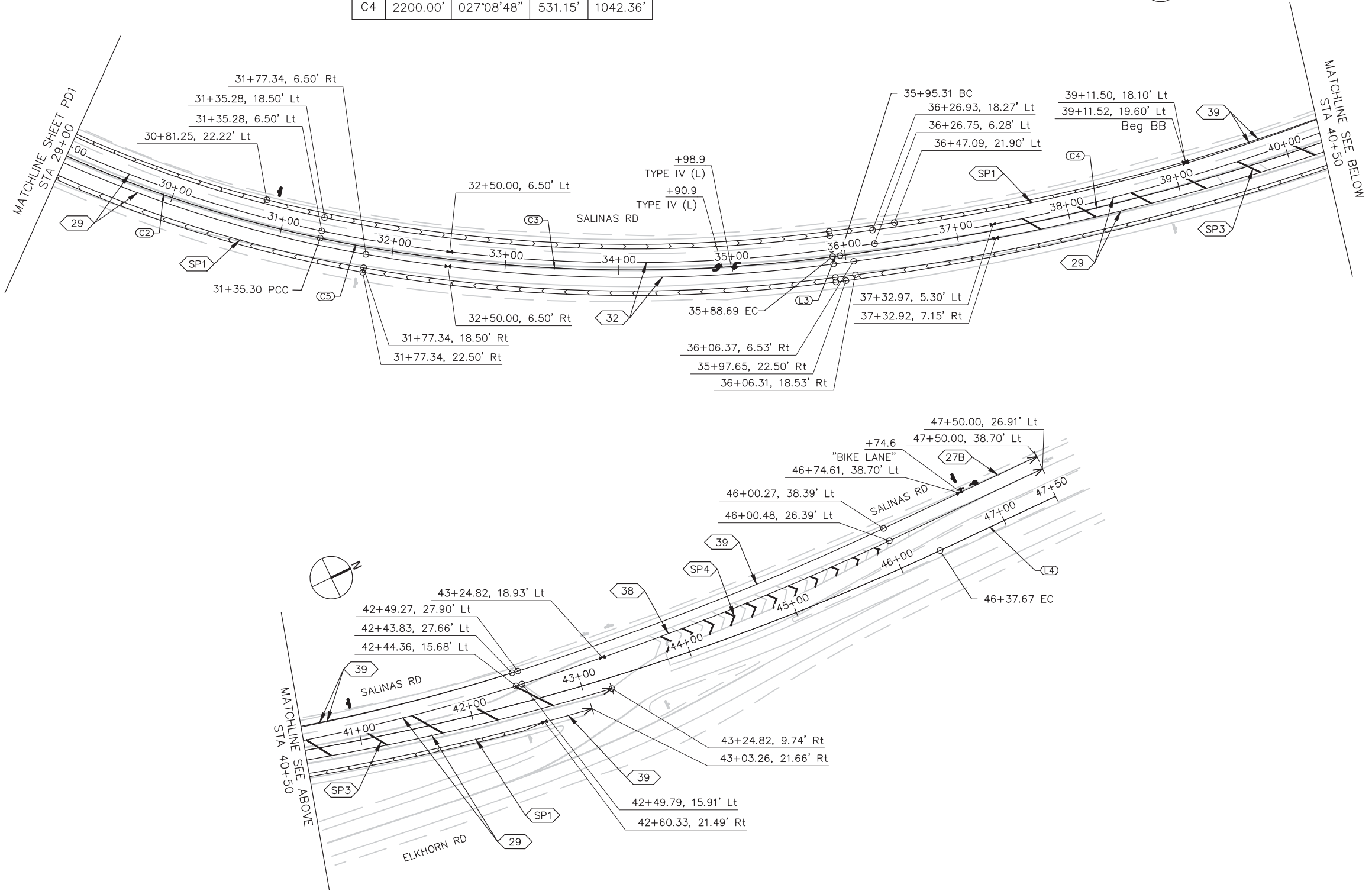

Drawing Name: C:\PWS\2589\Salinas Road - Blk. PWS\2589\PD1.dwg Layout Tab: PD2 Jul 13 2020 - 11:48am jmw02

Submitted by: J. WALTER Design Engineer C.E. No. 41227	
DESIGN BY: E. SAMAY	CHKD BY:
DRAWN BY: E. SAMAY	CHKD BY: J. VANEGAS-MORAN
SPECIFICATIONS WRITTEN BY: J. WALTER	CHKD BY: J. WALTER
Approval Recommended by: Deputy Public Works Director, Engineering	

**GHD**  
669 Pacific Street, Suite A  
San Luis Obispo, CA 93401 USA  
T 1 805 242 0461 W www.ghd.com

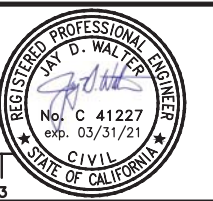

NO.	DATE	REVISION DESCRIPTION	APPROVED

**COUNTY OF MONTEREY**  
RESOURCE MGMT. AGENCY,  
DEPT. OF PUBLIC WORKS

168 WEST ALISAL STREET  
SALINAS, CALIFORNIA 93901  
(831) 755-4800/FAX (831) 755-4958

ELKHORN RD / WERNER RD / SALINAS RD INTERSECTION SAFETY IMPROVEMENT - PHASE I PAVEMENT DELINEATION			
DATE 07/13/2020	FILE	PROJECT NO. 11145015	SHEET PD2
SCALE 1"=50'		CONTRACT NO.	

SHEET NUMBER	TOTAL SHEETS
6	8

**LEGEND**

- EXISTING ONE POST SIGN
- ▲ EXISTING SIGN TO REMAIN
- REMOVE ROADSIDE SIGN
- RELOCATE ROADSIDE SIGN
- (X-X) SHEET NUMBER - ROADSIDE SIGN NUMBER
- ▬ PROPOSED ROADSIDE SIGN - ONE POST
- <CA> CALIFORNIA SIGN CODE

**NOTES**

1. ALL SIGN CODES SHOWN ARE FEDERAL SIGN CODES UNLESS OTHERWISE DESIGNATED AS CALIFORNIA SIGN CODES "<CA>".
2. SIGN LOCATIONS SHOWN ARE APPROXIMATE. THE LOCATION/PLACEMENT OF ALL SIGNS SHALL BE APPROVED BY THE ENGINEER.

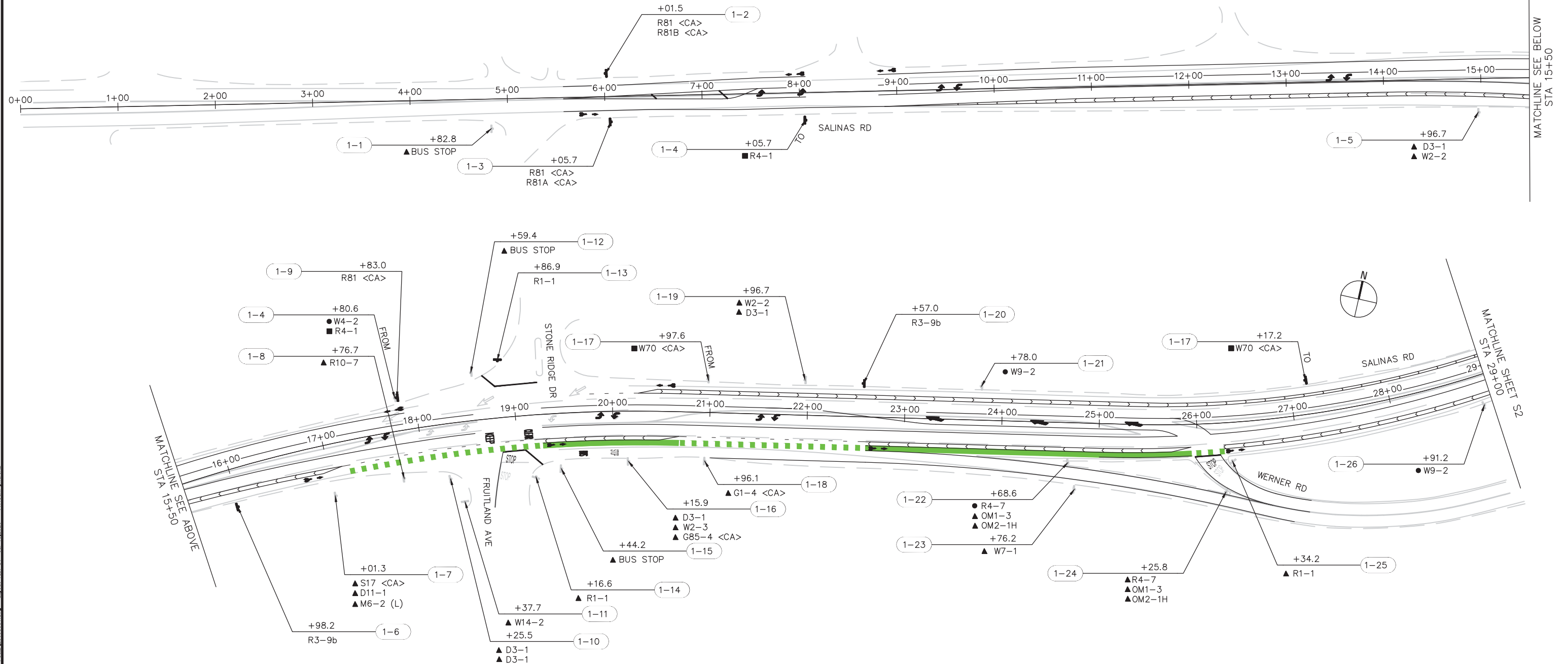

Drawing Name: C:\P\0\258\Salinas Road - Blk. P\02\258\001.dwg Layout Tab: S1 Jul 13 2020 - 11:46am jmw:m2

Submitted by: J. WALTER Design Engineer C.E. No. 41227	
DESIGN BY: E. SAMAY	CHKD BY:
DRAWN BY: E. SAMAY	CHKD BY: J. VANEGAS-MORAN
SPECIFICATIONS WRITTEN BY: J. WALTER	CHKD BY: J. WALTER
Approval Recommended by: Deputy Public Works Director, Engineering	

**GHD**  
 669 Pacific Street, Suite A  
 San Luis Obispo, CA 93401 USA  
 T 1 805 242 0461 W www.ghd.com



NO.	DATE	REVISION DESCRIPTION	APPROVED

**COUNTY OF MONTEREY**  
 RESOURCE MGMT. AGENCY,  
 DEPT. OF PUBLIC WORKS

168 WEST ALISAL STREET  
 SALINAS, CALIFORNIA 93901  
 (831) 755-4800/FAX (831) 755-4958

ELKHORN RD / WERNER RD / SALINAS RD INTERSECTION SAFETY IMPROVEMENT - PHASE I			
<b>SIGN PLAN</b>			
DATE 07/13/2020	FILE	PROJECT NO. 11145015	SHEET S1
SCALE 1"=50'		CONTRACT NO.	



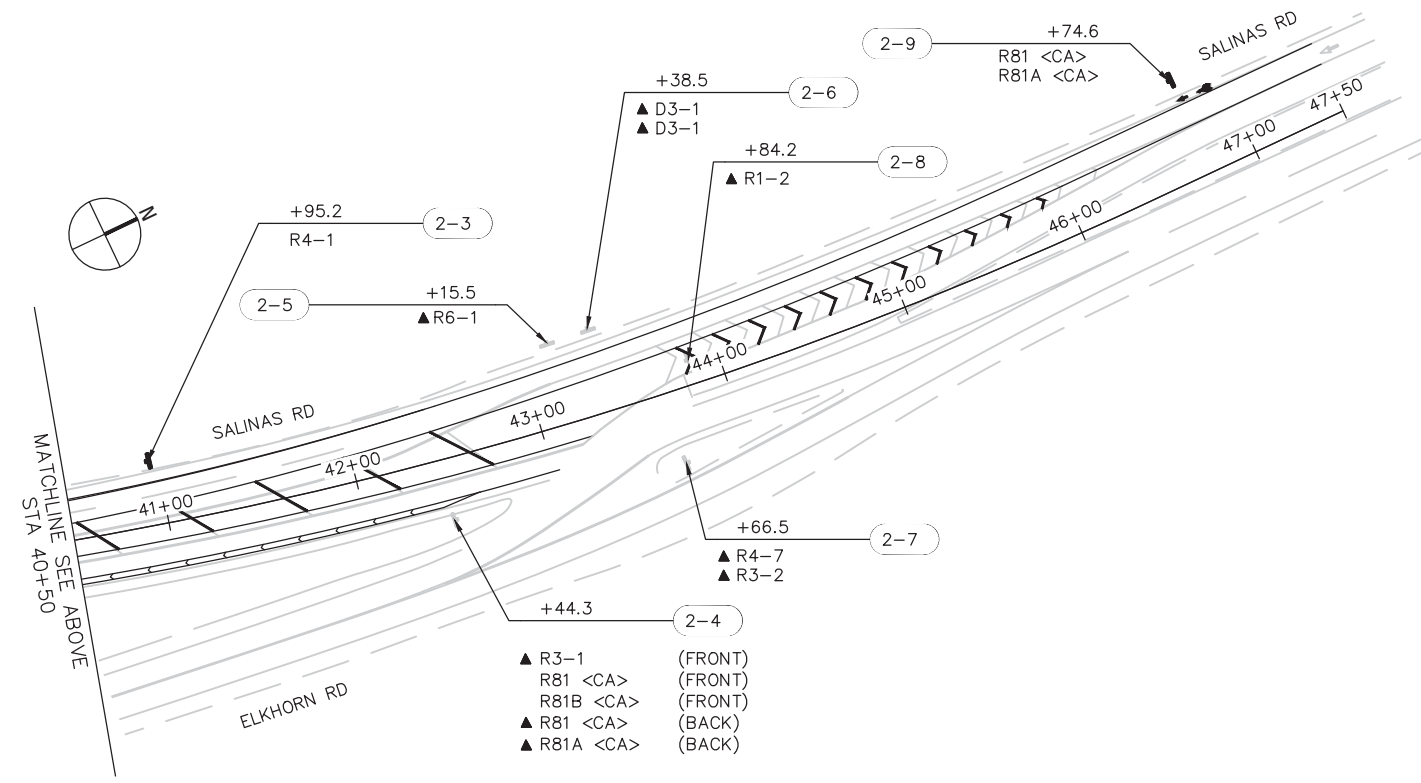
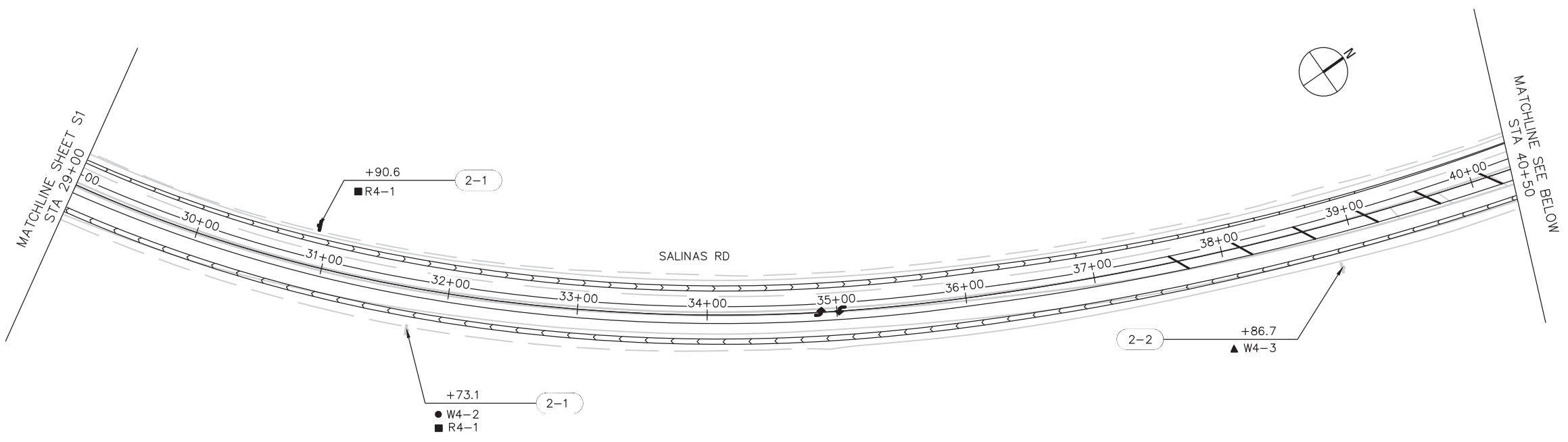

Submitted by: J. WALTER  
 Design Engineer C.E. No. 41227

DESIGN BY: E. SAMAY	CHKD BY:
DRAWN BY: E. SAMAY	CHKD BY: J. VANEGAS-MORAN
SPECIFICATIONS WRITTEN BY: J. WALTER	CHKD BY: J. WALTER

Approval Recommended by: Deputy Public Works Director, Engineering



669 Pacific Street, Suite A  
 San Luis Obispo, CA 93401 USA  
 T 1 805 242 0461 W www.ghd.com



NO.	DATE	REVISION DESCRIPTION	APPROVED



COUNTY OF MONTEREY  
 RESOURCE MGMT. AGENCY,  
 DEPT. OF PUBLIC WORKS

168 WEST ALISAL STREET  
 SALINAS, CALIFORNIA 93901  
 (831) 755-4800/FAX (831) 755-4958

ELKHORN RD / WERNER RD / SALINAS RD INTERSECTION  
 SAFETY IMPROVEMENT - PHASE I

### SIGN PLAN

DATE 07/13/2020	FILE	PROJECT NO. 11145015	SHEET S2
SCALE 1"=50'	CONTRACT NO.		

Drawing Name: C:\PWA\2589\Salinas Road - Blk. PWS\2589S01.dwg Layout Tab: S2 Jul 13 2020 - 11:45am jmw2

ROADSIDE SIGNS TO REMAIN

SHEET No.	SIGN No.	SIGN CODE
S-1	1-1	BUS STOP
	1-5	D3-1
		W2-2
	1-7	S17 <CA>
		D11-1
	1-8	M6-2
		R10-7
	1-10	D3-1
		D3-1
	1-11	W14-2
	1-12	BUS STOP
	1-14	R1-1
	1-15	BUS STOP
	1-16	D3-1
		W2-3
G85-4 <CA>		
1-18	G1-4	
1-19	W2-2	
	D3-1	
	OM1-3	
	OM2-1H	
1-23	W7-1	
1-24	R4-7	
	OM1-3	
1-25	OM2-1H	
	R1-1	
S-2	2-1	W4-2
	2-2	W4-3
	2-4	R3-1
		R81 <CA>
	2-4	R81A <CA>
		R6-1
	2-6	D3-1
		D3-1
	2-7	R4-7
		R3-2
2-8	R1-2	

ROADSIDE SIGNS TO INSTALL

SHEET No.	SIGN No.	SIGN CODE
S-1	1-2	R81 <CA>
		R81B <CA>
	1-3	R81 <CA>
		R81A <CA>
	1-6	R3-9b
	1-9	R81 <CA>
1-13	R1-1	
S-2	1-20	R3-9b
	2-3	R4-1
	2-4	R81 <CA>
		R81B <CA>
	2-9	R81 <CA>
	R81A <CA>	

ROADSIDE SIGNS TO RELOCATE

SHEET No.	SIGN No.	SIGN CODE
S-1	1-4	R4-1
	1-17	W70
	1-22	R4-7
S-2	2-1	R4-1

ROADSIDE SIGNS TO REMOVE

SHEET No.	SIGN No.	SIGN CODE
S-1	1-4	W4-2
	1-21	W9-2
	1-26	W9-2

Drawing Name: C:\PWA\2589\Salinas Road Blvd\_PWA\2589S01.dwg Layout Tab: S01 Jul 13, 2020 - 11:40am jmwant2

Submitted by: J. WALTER Design Engineer C.E. No. 41227	
DESIGN BY: E. SAMAY	CHKD BY:
DRAWN BY: E. SAMAY	CHKD BY: J. VANEGAS-MORAN
SPECIFICATIONS WRITTEN BY: J. WALTER	CHKD BY: J. WALTER
Approval Recommended by: Deputy Public Works Director, Engineering	



669 Pacific Street, Suite A  
San Luis Obispo, CA 93401 USA  
T 1 805 242 0461 W www.ghd.com

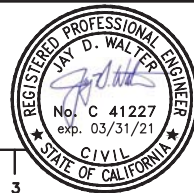

NO.	DATE	REVISION DESCRIPTION	APPROVED
△			
△			
△			
△			
△			
△			



COUNTY OF MONTEREY  
RESOURCE MGMT. AGENCY,  
DEPT. OF PUBLIC WORKS  
168 WEST ALISAL STREET  
SALINAS, CALIFORNIA 93901  
(831) 755-4800/FAX (831) 755-4958

ELKHORN RD / WERNER RD / SALINAS RD INTERSECTION SAFETY IMPROVEMENT - PHASE I SIGN QUANTITIES			
DATE 07/13/2020	FILE	PROJECT NO. 11145015	SHEET SQ1
SCALE NO SCALE		CONTRACT NO.	

**MONTEREY COUNTY  
RESOURCE MANAGEMENT AGENCY**

---

**PUBLIC WORKS**

---

**BOOK ONE**

**NOTICE TO BIDDERS  
AND  
SPECIAL PROVISIONS**

**ELKHORN RD / WERNER RD / SALINAS RD  
INTERSECTION SAFETY IMPROVEMENT - PHASE 1  
PROJECT NO. 1166**



**NOTICE TO BIDDERS  
AND  
SPECIAL PROVISIONS**

**ELKHORN RD / WERNER RD / SALINAS RD  
INTERSECTION SAFETY IMPROVEMENT - PHASE 1  
PROJECT NO. 1166**

**The Special Provisions contained herein have been prepared by or under the direction of the following registered person.**

  
\_\_\_\_\_  
*Jay D. Walter*

July 13, 2020  
*Date*

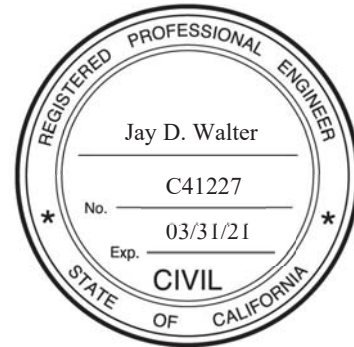

FOR USE IN CONNECTION WITH THE STANDARD SPECIFICATIONS 2018, THE STANDARD PLANS 2018, INCLUDING ISSUED REVISED STANDARD PLANS AND REVISED STANDARD SPECIFICATIONS. THE CURRENT LABOR SURCHARGE EQUIPMENT RENTAL RATES, OF THE STATE OF CALIFORNIA, DEPARTMENT OF TRANSPORTATION, BUSINESS AND TRANSPORTATION AGENCY; THE CURRENT GENERAL PREVAILING WAGE DETERMINED BY THE DIRECTOR OF INDUSTRIAL RELATIONS IS ON FILE WITH THE DEPARTMENT OF PUBLIC WORKS.

APPROVED AS TO FORM  
*9-2-2020*

APPROVED AS TO INDEMNITY/  
INSURANCE LANGUAGE  
9/3/2020

APPROVED AS TO FISCAL TERMS  
9/3/2020

  
\_\_\_\_\_  
MARY GRACE PERRY  
Deputy County Counsel

DocuSigned by:  
  
\_\_\_\_\_  
6B874A69C022B4...  
LESLIE J. GIRARD  
County Counsel-Risk Manager

DocuSigned by:  
  
\_\_\_\_\_  
D3832BFEC1D8448...  
GARY GIBONEY  
Chief Deputy Auditor Controller



## TABLE OF CONTENTS

<b>TABLE OF CONTENTS .....</b>	<b>4</b>
<b>NOTICE TO BIDDERS .....</b>	<b>7</b>
<b>SECTION 1 – DEFINITION AND TERMS .....</b>	<b>9</b>
1-1.01 SPECIFICATIONS AND PLANS: .....	9
1-1.02 INTERPRETATION OF STANDARD SPECIFICATIONS: .....	9
1-1.03 DEFINITIONS: .....	9
1-1.04 DEFINITIONS IN SPECIAL PROVISIONS: .....	10
1-1.05 STATE HOLIDAYS: .....	10
<b>SECTION 2 - BIDDING .....</b>	<b>10</b>
2-1.01 GENERAL: .....	10
2-1.02 BID OPENING: .....	10
2-1.03 SUBCONTRACTORS LIST: .....	10
2-1.04 JOB SITE AND DOCUMENT EXAMINATION: .....	11
2-1.05 GOOD FAITH EFFORT TO EMPLOY RESIDENTS OF MONTEREY BAY AREA: .....	11
<b>SECTION 3. CONTRACT AWARD AND EXECUTION .....</b>	<b>13</b>
3-1.01 GENERAL: .....	13
3-1.02 CONTRACT BONDS (PUBLIC CONTRACT CODE SECTIONS 10221 AND 10222): .....	14
3-1.03 CONTRACTOR REGISTRATION WITH THE DEPARTMENT OF INDUSTRIAL RELATIONS: .....	14
<b>SECTION 4 SCOPE OF WORK .....</b>	<b>14</b>
4-1.01 WORK DESCRIPTION .....	14
4-1.02 INCREASED AND DECREASED QUANTITIES: .....	14
4-1.03 BALANCING CHANGE ORDER: .....	15
<b>SECTION 5 – CONTROL OF WORK.....</b>	<b>15</b>
5-1.01 SUBCONTRACTING: .....	15
5-1.02 AREAS FOR CONTRACTOR’S USE: .....	15
<b>SECTION 6 – CONTROL OF MATERIALS.....</b>	<b>16</b>
6-1.01 GENERAL: .....	16
6-1.02 RELATIVE COMPACTION: .....	16
6-1.03 AUTHORIZED MATERIAL LIST: .....	16
6-1.04 QUALITY ASSURANCE: .....	17
<b>SECTION 7-LEGAL RELATIONS AND RESPONSIBILITY .....</b>	<b>17</b>
7-1.01 LABOR NON DISCRIMINATION: .....	17
7-1.02 LABOR CODE REQUIREMENT: .....	17
7-1.03 GENERAL PREVAILING WAGE RATES: .....	17
7-1.04 PAYROLL RECORDS: .....	18
7-1.05 SURFACE MINING AND RECLAMATION ACT: .....	18
7-1.06 PUBLIC SAFETY: .....	18
7-1.07 INDEMNIFICATION AND INSURANCE: .....	18
7-1.08 WORKERS’ COMPENSATION AND EMPLOYER’S LIABILITY INSURANCE: .....	19
<b>SECTION 8 - PROSECUTION AND PROGRESS.....</b>	<b>20</b>
8-1.01 BEGINNING OF WORK, TIME OF COMPLETION AND LIQUIDATED DAMAGES: .....	20
8-1.02 PRE-CONSTRUCTION CONFERENCE: .....	20
8-1.03 SCHEDULE: .....	20
<b>SECTION 9 – PAYMENT .....</b>	<b>20</b>
9-1.01 PROMPT PROGRESS PAYMENT TO SUBCONTRACTORS: .....	20
9-1.02 PAYMENT ADJUSTMENTS FOR PRICE INDEX FLUCTUATIONS: .....	21

9-1.03 PROGRESS PAYMENTS AND PAYMENTS AFTER CONTRACT ACCEPTANCE: .....21  
9-1.04 ARBITRATION: .....21  
**SECTION 10 – GENERAL.....24**  
10-1.01 WORK SEQUENCING:.....24  
**SECTION 12 TEMPORARY TRAFFIC CONTROL .....25**  
12-1.01 FLAGGING COSTS: .....25  
12-1.02 PORTABLE CHANGEABLE MESSAGE SIGN:.....25  
12-1.03 IMPACT ATTENUATOR VEHICLE: .....25  
12-1.04 PORTABLE TRANSVERSE RUMBLE STRIP: ..... **ERROR! BOOKMARK NOT DEFINED.**  
12-1.05 MAINTAINING TRAFFIC: .....26  
12-1.06 TRAFFIC CONTROL SYSTEM FOR LANE CLOSURE: .....27  
**SECTION 17 – CLEARING AND GRUBBING.....29**  
17-1.01 CLEARING AND GRUBBING: .....29  
**APPENDIX I - SAMPLE CONTRACT .....30**  
SAMPLE AGREEMENT .....30  
PAYMENT BOND.....35  
PERFORMANCE BOND .....37

## STANDARD PLANS LIST

The Standard Plan sheets applicable to this contract include, but are not limited to those indicated below. The Standard Plans of 2018 and the Revised Standard Plans, which apply to this contract, are included as attachments to these Special Provisions.

### GENERAL ROAD WORK

#### MISCELLANEOUS

A3A	Abbreviations
A3B	Abbreviations
A3C	Abbreviations
A10A	Legend - Lines and Symbols
A20A	Pavement Markers and Traffic Lines - Typical Details
A20B	Pavement Markers and Traffic Lines - Typical Details
A20C	Pavement Markers and Traffic Lines - Typical Details
A20D	Pavement Markers and Traffic Lines - Typical Details
A24A	Pavement Markings – Arrows
A24B	Pavement Markings – Arrows and Symbols
A24C	Pavement Markings - Symbols and Numerals
A24D	Pavement Markings – Words
A24E	Pavement Markings – Words, Limit and Yield Lines
A73B	Markers
A87B	Hot Mix Asphalt Dikes

#### TEMPORARY FACILITIES

T11	Traffic Control System for Lane Closure On Multilane Conventional Highways
T12	Traffic Control System for Half Road Closure On Multilane Conventional Highways and Expressways
T13	Traffic Control System for Lane Closure On Two Lane Conventional Highways
T17	Traffic Control System for Moving Lane Closure On Two Lane Highways

#### ROADSIDE SIGNS

RS1	Roadside Signs - Typical Installation Details No. 1
RS2	Roadside Signs - Wood Post, Typical Installation Details No. 2



COUNTY OF MONTEREY  
RESOURCE MANAGEMENT AGENCY – PUBLIC WORKS

**NOTICE TO BIDDERS**

Sealed bids will be received at the OFFICE OF THE CLERK OF THE BOARD OF SUPERVISORS, COUNTY OF MONTEREY, 168 W. ALISAL STREET 1<sup>ST</sup> FLOOR, SALINAS, CALIFORNIA 93901 (MAILING ADDRESS: P O BOX 1728, SALINAS CA 93902-1728), until 2:00 p.m., on **October 23<sup>rd</sup> 2020**, for the:

ELKHORN RD / WERNER RD / SALINAS RD  
INTERSECTION SAFETY IMPROVEMENT - PHASE 1  
PROJECT NO. 1166

as shown on the plans, at which time they will be publicly opened and read in the Board of Supervisors' Conference Room 1032.

The work to be done consists of removing all thermoplastic pavement markings, pavement markers, performing full width slurry seal over the existing pavement,, installing new pavement delineation, installing new traffic signage , and traffic control. The Engineer's Estimate for this project is \$ 247,552.45.

The Bidder shall possess either a valid Class A license or a combination of Class C-12, C-31, C-32, and C-45 licenses, at the time of the bid opening.

A bidder's bond, issued by an admitted corporate surety company in an amount equal to at least ten percent (10%) of the amount bid, must accompany the bid.

The successful bidder shall furnish a payment bond and a performance bond each in the amount of one hundred percent (100%) of the Contract.

The Contract Documents are available ELECTRONICALLY and can be downloaded for free at the following Monterey County website: <http://www.co.monterey.ca.us/publicworks/bids.htm>. Plan holders must register before they can view or download the documents. A copy of the electronic files on compact-disc (CD) is also available at MONTEREY COUNTY RESOURCE MANAGEMENT AGENCY, PUBLIC WORKS, 1441 SCHILLING PLACE, SALINAS, CALIFORNIA 93901 for a nonrefundable fee of \$5.00. The electronic files can be used to print the project plans, project specifications, and other such documents at various printing companies.

Pursuant to Section 5.08.120 of the Monterey County Code, all contractors and subcontractors providing work, laborers, or materialmen on the project shall make a good-faith effort to employ qualified individuals who are, and have been for at least one (1) year out of the past three (3) years prior to the opening of bids residents of the Monterey Bay Area in sufficient numbers so that no less than fifty percent (50%) of the contractor's total construction work force, on the project, including any subcontractor work force (with exception of specialty subcontractor items identified in the bid items) measured in labor work hours is comprised of Monterey Bay Area residents.

Pursuant to Section 1773 of the Labor Code, the general prevailing wage rates in the county, or counties, in which the work is to be done have been determined by the Director of the California Department of Industrial Relations and are available at the Resource Management Agency, Public Works, 1441 Schilling Place, Salinas, CA 93901, and available from the California Department of Industrial Relations' Internet web site at <http://www.dir.ca.gov/DLSR/PWD>.

Pursuant to Labor Code section 1771.1(a), a contractor or subcontractor shall not be qualified to bid on, be listed in a bid proposal, subject to the requirements of Section 4104 of the Public Contract Code, or engage in the performance of any contract for public work, as defined in this chapter, unless currently registered and qualified to perform public work pursuant to Labor Code Section 1725.5. It is not a violation of this section for an unregistered contractor to submit a bid that is authorized by Section 7029.1 of the Business and Professions Code or by Section 10164 or 20103.5 of the Public Contract Code, provided the contractor is registered to perform public work pursuant to Labor Code Section 1725.5 at the time the contract is awarded.

This project is subject to compliance monitoring and enforcement by the Department of Industrial Relations.

Pursuant to Public Contract Code section 22300, the Contractor may substitute securities for any moneys withheld by the County to ensure performance under the contract.

The County reserves the right to reject any or all bids or to waive any irregularities or informalities in any bids or in the bidding.

Date: **August 28, 2020**

COUNTY OF MONTEREY

RESOURCE MANAGEMENT AGENCY  
DEPARTMENT OF PUBLIC WORKS  
COUNTY OF MONTEREY  
STATE OF CALIFORNIA

**SPECIAL PROVISIONS**

**ELKHORN RD / WERNER RD / SALINAS RD  
INTERSECTION SAFETY IMPROVEMENT - PHASE 1  
PROJECT NO. 1166**

**SECTION 1 – DEFINITION AND TERMS**

**1-1.01 SPECIFICATIONS AND PLANS:**

The work embraced herein shall be done in accordance with the Standard Specifications and Standard Plans, of 2018, of the State of California, Department of Transportation, as revised, insofar as the same may apply and in accordance with the following Special Provisions:

In case of conflict between the Standard Specifications and these Special Provisions, the Special Provisions shall take precedence over and be used in lieu of such conflicting portions. The listing of certain salient sections from the Standard Specifications and these Special Provisions shall not in any way relieve the Contractor of complying with each and every section of the Standard Specifications.

Revisions to the Standard Specifications set forth in these special provisions shall be considered as part of the Standard Specifications for the purposes set forth in Section 5-1.02 "Contract Components" of the Standard Specifications. Whenever either the term "Standard Specifications is revised" or the term "Standard Specifications are revised" is used in the special provisions, the indented text or table following the term shall be considered Revised Standard Specifications. In case of conflict between such revisions and the Standard Specifications, the revision shall take precedence over and be used in lieu of the conflicting portions.

**1-1.02 INTERPRETATION OF STANDARD SPECIFICATIONS:**

For the purpose of this Contract, certain terms or pronouns in place of them used throughout the Standard Specifications, shall be interpreted as follows: Attention is directed to Section 1, "Definition and Terms," of the Standard Specifications and these Special Provisions.

**1-1.03 DEFINITIONS:**

The following terms defined in Section 1-1.07, "Definitions," of the Standard Specifications shall be interpreted to have the following meaning and intent:

- State: County of Monterey
- Department: Monterey County Resource Management Agency
- Director: Chair of the Board of Supervisors
- Engineer: Resource Management Agency Director of Public Works, acting

either directly or through properly authorized agents, such agents acting within the scope of the particular duties entrusted to them.

1-1.04 DEFINITIONS IN SPECIAL PROVISIONS:

Whenever in the Special Provisions and other Contract documents, the following terms, or pronouns in place of them are used, the intent and meaning shall be interpreted as follows:

- Clerk of the Board:                   The Clerk of the Monterey County Board of Supervisors
  
- Director of Public Works:       Resource Management Agency Director of Public Works.
  
- Attorney General:                 County Counsel-Risk Manager of Monterey County
  
- Laboratory:                         Any established laboratory designated by the Engineer to test materials and work involved in the Contract.

1-1.05 STATE HOLIDAYS:

Attention is directed to definition of **holiday** in Section 1-1.07B "Glossary" of the Standard Specifications.

**SECTION 2 - BIDDING**

2-1.01 GENERAL:

The bidder's attention is directed to the provisions in Section 2, "Bidding," of the Standard Specifications and these Special Provisions for the requirements and conditions which he/she/it must observe in the preparation and the submission of the bid.

The Bidder's Bond form mentioned in the last paragraph in Section 2-1.34, "Bidder's Security," of the Standard Specifications will be found in the Bid Form, Book Two. Bidder's security in the form of cashier's check or certified check shall be made payable to the County of Monterey.

In conformance with Public Contract Code Section 7106, a Noncollusion Declaration is included in the Bid Form, Book Two. Signing the Bid shall also constitute signature of the Noncollusion Declaration.

This Contract will require a Class "A" contractor's license or a combination of Class C-12, C-31, C-32, and C-45 licenses.

2-1.02 BID OPENING:

The Agency publicly opens and reads bids at the time and place shown on the *Notice to Bidders*.

2-1.03 SUBCONTRACTORS LIST:

Each bid shall have listed therein the name and address of each Subcontractor to whom the bidder proposes to subcontract portions of the work in an amount in excess of one-half of one percent of his/her/its total bid or \$10,000, whichever is greater, in accordance with the Subletting and Subcontracting Fair Practices Act, commencing with Section 4100 of the Public Contract Code.

The bidder's attention is directed to other provisions of said Act related to the imposition of penalties for a failure to observe its provisions by using unauthorized Subcontractors or by making unauthorized substitutions.

A sheet for listing the Subcontractors, as required herein by law, is included in the Bid

2-1.04 JOB SITE AND DOCUMENT EXAMINATION:

The bidder shall examine carefully the site of the work contemplated, the specifications, and the proposal and Contract forms therefor. The submission of a bid shall be conclusive evidence that the bidder has investigated and is satisfied as to the general and local conditions to be encountered, as to the character, quality and scope of work to be performed, the quantities of materials to be furnished and as to the requirements of the proposal, plans, specifications and the Contract.

The submission of a bid shall also be conclusive evidence that the bidder is satisfied as to the character, quality and quantity of surface and subsurface materials or obstacles to be encountered insofar as this information was reasonably ascertainable from an inspection of the site as well as from the specifications made a part of the Contract.

All bidder inquiries about the meaning or intent of the Contract Documents submitted to the Engineer shall be in writing. Replies to the inquiries will be in the form of addenda and will be mailed, faxed, or delivered to all parties recorded by the Engineer as having received the bidding documents. Issued addenda shall be considered as part of the Contract Documents. Bidder inquiries received less than ten (10) days prior to the date of bid opening will not be answered. Oral and other interpretations or clarifications will be without legal effect.

The County assumes no responsibility for conclusions or interpretations made by a bidder or Contractor based on the information or data made available by the County. The County does not assume responsibility for representation made by its officers or agents before the execution of the Contract concerning surface or subsurface conditions, unless that representation is expressly stated in the Contract.

No conclusions or interpretations made by a bidder or Contractor from the information and data made available by the County will relieve a bidder or Contractor from properly fulfilling the terms of the Contract.

2-1.05 GOOD FAITH EFFORT TO EMPLOY RESIDENTS OF MONTEREY BAY AREA:

In accordance with Section 5.08.120 of the Monterey County Code (MCC), all contractors and subcontractors providing work, laborers, or materialmen/women on the project shall make a good-faith effort to employ qualified individuals who are, and have been for at least one (1) year out of the past three (3) years prior to the opening of bids residents of the Monterey Bay Area in sufficient numbers so that no less than fifty percent (50%) of the contractor's total construction work force, on the project, including any subcontractor work force (with exception of specialty subcontractor items identified in the bid items) measured in labor work hours is comprised of Monterey Bay Area residents. A certification form relating to compliance with Section 5.08.120 is furnished with the bid documents. You must complete the certification form and submit the certification form with the sealed bid. The Monterey County Board of Supervisors may deem your bid non-responsive for failure to abide by the good-faith local hiring provisions of Section

## 5.08.120.

If any contractor submitting a bid for a contract for public works of improvement fails to abide by the good-faith local employment provisions of this Section, the contractor may be declared by the Board to be a non-responsive bidder for purposes of this Chapter. If a contractor lists in his or her bid a subcontractor who is currently disqualified under the terms of this Section, the Board may declare said contractor to be a non-responsive bidder for purposes of this Chapter. If the Board finds that a contractor to whom a contract for a public work of improvement has been awarded has failed to comply with the good-faith employment provisions of this Section during the performance of the contract, the Board may disqualify the contractor from bidding on any County contract for a public work of improvement for a period of one (1) year from the date of the Board's disqualification of said contractor. A subsequent violation of this Section by a contractor may result in disqualification by the Board for a period of three (3) years from the date of the subsequent disqualification.

"Resident of Monterey Bay Area" means a person who resides within the boundaries of Monterey County, Santa Cruz County, or San Benito County.

A "good-faith effort" means the contractor will take the following or similar actions to recruit and maintain Monterey Bay Area residents as part of the construction workforce:

- Contact local recruitment sources, including local hiring halls, to identify qualified individuals who are Monterey Bay Area residents;
- Advertise for qualified Monterey Bay Area residents in trade papers, electronic/"on-line" sources, and a newspapers of general circulation in the Monterey Bay Area, unless time limits imposed by the County do not permit such advertising.
- If portions of the work are to be performed by subcontractors, identify qualified subcontractors whose work force includes Monterey Bay Area residents; and
- If current workforce does not exceed the fifty (50) percent local requirement, develop a written plan to recruit Monterey Bay Area residents as part of the construction workforce.

The Contractor shall keep an accurate record on a standardized form showing the name, place of residence, trade classifications, hours worked, proof of journeyman or apprenticeship status, per diem wages and benefits of each person employed by the contractor, the contractor's subcontractors on the project, including full-time, part-time, permanent and temporary employees, and make sure records are available to the County with submission of final certified payroll records prior to final payment.

The Contractor shall keep, and provide to the County, on forms acceptable to the County, an accurate record documenting compliance with this provision. Said records shall include; a listing by name and business address of all local recruitment sources contacted by the contractor, the date of the local recruitment contact and the identity of the person contacted, the trade and classification and number of hire referrals requested, the number of local hires made as a result of the contract, and the identity of business address of the person(s) hired pursuant to the contact.

At the conclusion of the project and at other intervals as may be deemed appropriate by the Engineer, the contractor shall provide a summary report of the percentage of actual labor work hours performed by Monterey Bay Area residents on the project.

Contractors and subcontractors are referred to the provisions of MCC Section 5.08.120 and the rules, regulations, and procedures adopted to implement Section 5.08.120, which are online at:

[https://library.municode.com/ca/monterey\\_county/codes/code\\_of\\_ordinances?nodeId=TI\\_T5REFI\\_CH5.08BI\\_5.08.120LOEMUBWOCO](https://library.municode.com/ca/monterey_county/codes/code_of_ordinances?nodeId=TI_T5REFI_CH5.08BI_5.08.120LOEMUBWOCO)

### **SECTION 3. CONTRACT AWARD AND EXECUTION**

#### **3-1.01 GENERAL:**

The bidder's attention is directed to the provisions in Section 3, "Contract Award and Execution," of the Standard Specifications and these special provisions for the requirements and conditions concerning award and execution of contract.

In lieu of Section 3-1.04, "Contract Award," of the Standard Specifications, insert the following:

Bidders who wish to lodge a protest as to the award of the bid must do so before 5 p.m. of the fifth business day following the notice of intent to award the contract. Failure to timely file a written protest shall constitute a waiver of right to protest. Untimely protests will not be accepted or considered. Bid protests must be submitted, in writing, to: MONTEREY COUNTY RESOURCE MANAGEMENT AGENCY, PUBLIC WORKS, TO THE ATTENTION OF THE PROJECT MANAGER, 1441 SCHILLING PLACE, SALINAS, CALIFORNIA 93901-2438. Protests may be hand-delivered or sent via facsimile [(831)755-4958], certified postal mail, or E-mail to the attention of the project manager [The Project Manager's E-mail address may be obtained by calling (831) 755-4800]. Bid protests must include the project name and project number, a complete statement describing the basis for the bid protest, including a detailed statement of all legal and factual grounds for the protest, any documentation supporting the protestor's grounds for the protest, and the form of relief requested and the legal basis for such relief. The party lodging the protest must also include their contact information including mailing address, telephone number, and E-mail address.

If a valid protest is timely filed, the Department shall investigate the bid protest. The protested bidder shall have three (3) business days to respond to any Department of Public Works requests to provide additional information. The Department shall respond to the protesting party, stating its finding. The Department Director shall make a recommendation to the Board regarding the bid protest.

The award of the contract, if it be awarded, will be to the lowest responsible bidder within ninety (90) days after bid opening, whose bid complies with all the requirements prescribed.

In determining the lowest "responsible" Bidder, consideration shall be given to the general competency of Bidder with regard to the work covered by the bid.

The contract shall be executed by the successful bidder and shall be returned, together with the contract bonds and insurance certificates, to the MONTEREY COUNTY RESOURCE

MANAGEMENT AGENCY, PUBLIC WORKS so that it is received within ten (10) working days, not including Saturdays, Sundays and legal holidays, after the bidder has received the contract for execution. Failure to do so shall be just cause for forfeiture of the bid guaranty. The executed contract documents shall be delivered to the following address: MONTEREY COUNTY RESOURCE MANAGEMENT AGENCY, PUBLIC WORKS, 1441 SCHILLING PLACE, SALINAS, CALIFORNIA, 93901-2438.

3-1.02 CONTRACT BONDS (PUBLIC CONTRACT CODE SECTIONS 10221 AND 10222):

In lieu of the second paragraph in Section 3-1.05 “Contract Bonds (Public Contract Code Sections 10221 and 10222)” of the Standard Specifications, the following shall be inserted:

2. Performance bond to guarantee the faithful performance of the Contract. This bond must be equal to at least one hundred percent (100%) of the total bid.

The two (2) bonds shall be written by an admitted corporate surety.

3-1.03 CONTRACTOR REGISTRATION WITH THE DEPARTMENT OF INDUSTRIAL RELATIONS:

Attention is directed to Department of Industrial Relations Contractor registration for public works project.

Pursuant to Labor Code section 1771.1(a), a contractor or subcontractor shall not be qualified to bid on, be listed in a bid proposal, subject to the requirements of Section 4104 of the Public Contract Code, or engage in the performance of any contract for public work, as defined in this chapter, unless currently registered and qualified to perform public work pursuant to Labor Code Section 1725.5. It is not a violation of this section for an unregistered contractor to submit a bid that is authorized by Section 7029.1 of the Business and Professions Code or by Section 10164 or 20103.5 of the Public Contract Code, provided the contractor is registered to perform public work pursuant to Labor Code Section 1725.5 at the time the contract is awarded.”

This project is subject to compliance monitoring and enforcement by the Department of Industrial Relations.

For Contractor Registration, go to: <http://www.dir.ca.gov/Public-Works/PublicWorks.html>

**SECTION 4 SCOPE OF WORK**

4-1.01 WORK DESCRIPTION

In general, the work consists of removing all thermoplastic pavement markings and pavement markers, performing full width slurry seal over the existing pavement, installing new pavement delineation, installing new traffic signage, and traffic control. Such other items or details, not mentioned above, that are required by the Plans, Standard Specifications, Standard Plans, or these Special Provisions, shall be performed, placed, constructed, or installed.

4-1.02 INCREASED AND DECREASED QUANTITIES:

The County reserves the right to increase, decrease or delete the quantities of items as follows:



ITEM CODE.	ITEM
1	Traffic Control System
2	Slurry Seal
3	Pavement Marker (Retroreflective)
4	Remove Roadside Sign
5	Relocate Roadside Sign-One Post
6	Roadside Sign-One Post
7	Thermoplastic Traffic Stripe
8	Thermoplastic Pavement Marking
9	Remove Thermoplastic Traffic Stripe
10	Remove Thermoplastic Pavement Marking
11	Pavement Marking (Green Paint)

The adjustment provision in Section 4-1.05 “Changes and Extra Work” of the Standard Specifications shall not apply to the above items.

Such other items or details, not mentioned above, that are required by the Plans, Standard Specifications, or these Special Provisions, shall be performed, placed, constructed, or installed.

4-1.03 BALANCING CHANGE ORDER:

Prior to submitting for the final estimate, a balancing change order adjusting quantities to reflect those actually used during construction will be issued.

## SECTION 5 – CONTROL OF WORK

5-1.01 SUBCONTRACTING:

Attention is directed to Section 5-1.13, "Subcontracting" of the Standard Specifications.

No subcontract releases the Contractor from the Contract or relieves the Contractor of their responsibility for a subcontractor's work.

If the Contractor violates Public Contract Code Section 4100 et seq., the County of Monterey may exercise the remedies provided under Public Contract Code Section 4110. The County of Monterey may refer the violation to the Contractors State License Board as provided under Public Contract Code Section 4111.

The Contractor shall perform work equaling at least thirty percent (30%) of the value of the original total bid with the Contractor's own employees and equipment, owned or rented, with or without operators.

5-1.02 AREAS FOR CONTRACTOR'S USE:

Attention is directed to the requirements specified in Section 5-1.32, "Areas for Use," of the Standard Specifications and these Special Provisions.

The County right-of-way shall be used only for purposes that are necessary to perform the required work. The Contractor shall not occupy the right-of-way, or allow others to occupy the right-of-way, for purposes that are not necessary to perform the required work.

There are no County owned parcels adjacent to the right-of-way for the exclusive use of the Contractor within the Contract limits. The Contractor shall secure at his/her/its own expense any area required for plant sites, storage of equipment or materials, or for other purposes.

Use of the Contractor's work areas and other County owned property shall be at the Contractor's own risk, and the County shall not be held liable for any damage to or loss of materials or equipment located within such areas.

The Contractor shall obtain encroachment permits prior to occupying County owned parcels outside the Contract limits. The required encroachment permits may be obtained from the MONTEREY COUNTY RESOURCE MANAGEMENT PUBLIC WORKS & FACILITIES, 1441 SCHILLING PLACE, 2<sup>ND</sup> FLOOR, SALINAS, CALIFORNIA 93901-2438.

Residence trailers will not be allowed within the county right-of-way.

The Contractor shall remove all equipment, materials, and rubbish from the work areas and other County owned property, which he/she/it occupies and shall leave the areas in a presentable condition, in accordance with the provisions in Section 4-1.13, "Clean Up," of the Standard Specifications.

The Contractor shall secure at his/her/its own expense any area required for plant sites, storage of equipment or materials, or for other purposes if sufficient area is not available to him/her/it within the Contract limits.

## **SECTION 6 – CONTROL OF MATERIALS**

### **6-1.01 GENERAL:**

Attention is directed to Section 6, "Control of Materials," of the Standard Specifications and these Special Provisions.

All materials required to complete the work under this contract shall be furnished by the Contractor, except as noted on the Plans.

### **6-1.02 RELATIVE COMPACTION:**

Wherever relative compaction is specified to be determined by Test Method No. California 216 or Test Method No. California 231 the relative compaction will be determined by Test Method No. California 231.

### **6-1.03 AUTHORIZED MATERIAL LIST:**

The Department maintains list of Authorized Materials List. The Engineer shall not be precluded from sampling and testing products on the list of Authorized Materials List.

The manufacturer of products on the list of Authorized Materials List shall furnish the Engineer a Certificate of Compliance in conformance with the provisions in Section 6-2.03C, "Certificates of Compliance," of the Standard Specifications for each type of product supplied.

For those categories of materials included on the list of Authorized Materials List, only those

products shown within the listing may be used in the work. Other categories of products, not included on the list of Authorized Materials List, may be used in the work provided they conform to the requirements of the Standard Specifications and as approved by the engineer.

For the Authorized Material Lists, go to: <http://www.dot.ca.gov/aml/>

**6-1.04 QUALITY ASSURANCE:**

The Department uses a Quality Assurance Program (QAP) to ensure a material is produced to comply with the Contract.

You may examine the records and reports of tests the Agency performs if they are available at the job site.

Schedule work to allow time for QAP.

**SECTION 7-LEGAL RELATIONS AND RESPONSIBILITY**  
**TO THE PUBLIC**

**7-1.01 LABOR NON DISCRIMINATION:**

Attention is directed to the following Notice that is required by Chapter 5 of Division 4 of Title 2, California Code of Regulations.

**NOTICE OF REQUIREMENT FOR NONDISCRIMINATION PROGRAM**  
**(GOVERNMENT CODE SECTION 12990)**

Your attention is called to the "Nondiscrimination Clause", set forth in Section 7-1.02I(2), "Nondiscrimination," of the Standard Specifications, which is applicable to all nonexempt state contracts and subcontracts, and to the "Standard California Nondiscrimination Construction Contract Specifications" set forth therein. The Specifications are applicable to all nonexempt state construction contracts and subcontracts of \$5,000 or more.

**7-1.02 LABOR CODE REQUIREMENT:**

Attention is directed to Section 7-1.02K (5), "Working Hours," of the Standard Specifications.

**7-1.03 GENERAL PREVAILING WAGE RATES:**

Attention is directed to Section 7-1.02K(2), "Wages," of the Standard Specifications.

The general prevailing wage rates determined by the Director of Industrial Relations, for the County or Counties in which the work is to be done, are available on the Internet at: <http://www.dir.ca.gov/dlsr/pwd/>. These wage rates are not included in the Bid book for the project. Changes, if any, to the general prevailing wage rates will be available at the same location.

The general prevailing rates of per diem, holiday, and overtime wages for each craft, classification, or type of worker needed to execute the Contract are determined in accordance with Labor Code Section 1770 et. seq.; and, the Contractor shall comply with all applicable sections thereof.

The Contractor shall post the prevailing wage rates at the job site or as directed by the Engineer.

For Federal minimum wage rates see the website <http://www.dot.ca.gov/hq/esc/oe/federal-wages/>.

If there is a difference between the minimum wage rates predetermined by the Secretary of Labor and the general prevailing wage rates determined by the Director of the California Department of Industrial Relations for similar classifications of labor, the Contractor and subcontractors shall pay not less than the higher wage rate. The Department will not accept lower State wage rates not specifically included in the Federal minimum wage determinations. This includes "helper" (or other classifications based on hours of experience) or any other classification not appearing in the Federal wage determinations. Where Federal wage determinations do not contain the State wage rate determination otherwise available for use by the Contractor and subcontractors, the Contractor and subcontractors shall pay not less than the Federal minimum wage rate, which most closely approximates the duties of the employees in question.

#### 7-1.04 PAYROLL RECORDS:

The Contractor's attention is directed to Section 7- 1.02K (3), "Certified Payroll Records," of the Standard Specifications, and to the provisions of Labor Code, Section 1776 (Stats. 1978, Chapter 1249). The Contractor shall be responsible for the compliance with these provisions by his/her/its Subcontractors. The Contractor shall furnish the Engineer with certified payrolls and statement of benefits.

The Department withholds from progress payments for not submitting records for local employment of Monterey Bay Area residents.

#### 7-1.05 SURFACE MINING AND RECLAMATION ACT:

Attention is directed to the Surface Mining and Reclamation Act of 1975 (SMARA), commencing in Public Resources Code (PRC), Division 2. Geology, Mines and Mining, Chapter 9. SMARA, PRC Section 2710, which establishes regulations pertinent to surface mining operations.

Material from mining operations furnished for this project shall only come from permitted sites in compliance with SMARA.

The requirements of this section shall apply to all materials furnished for the project, except for acquisition of materials in conformance with Section 4-1.04, "Use of Materials Found on the Job Site," of the Standard Specifications.

#### 7-1.06 PUBLIC SAFETY:

The Contractor shall provide for the safety of traffic and the public in conformance with the provisions in Section 7-1.04, "Public Safety," and Section 7-1.03, "Public Convenience" of the Standard Specifications and these special provisions.

#### 7-1.07 INDEMNIFICATION AND INSURANCE:

Attention is directed to Section 7-1.05, "Indemnification" and Section 7-1.06 "Insurance," of the Standard Specifications and these Special Provisions.

In addition to all the requirements in Section 7-1.06 D (2) "Liability Limits/Additional Insured," of the Standard Specifications, the following additional requirements shall be met. An Additional Insured Endorsement to the Contractor's Liability insurance policy naming the County of

Monterey, their officers, agents, and employees as additional insured's in the form approved by the County of Monterey shall also be furnished. A copy of the approved endorsement form may be obtained from the County of Monterey at the address to obtain bid packages as shown in the Notice to Bidders. The insurance afforded to the additional insured's is primary insurance and if the additional insured's have other insurance that might be applicable to any loss, the amount of this insurance shall not be reduced or prorated due to the existence of such other insurance.

The Contractor's insurer agrees to waive subrogation claims against the County of Monterey, their officers, agents, and employees.

Evidence of insurance (Contractual Liability insurance and Additional Insured Endorsement) in compliance with the requirements herein shall be furnished to the County of Monterey by the Contractor with the Certificate of Insurance in the form as approved by the County of Monterey. A copy of the approved certificate form may be obtained from the County of Monterey at the address to obtain bid packages as shown in the Notice to Bidders. Certificates of insurance shall, without any qualification thereto, contain the following statement:

Should any of the described policies be canceled, modified, or reduced in limits before the expiration date thereof, the issuing company will mail thirty days advance written notice to the named certificate holders.

The insurance shall be issued by a company or companies authorized to transact business in the State of California and shall have a rating of at least A- VII in accordance with the current Best's rating.

Insurance coverage in the minimum amounts set forth herein shall not be construed to relieve the Contractor for liability in excess of such coverage, nor shall it preclude the State of California or County of Monterey from taking such other actions as is available to them under any other provision of this Contract (except retainage of money due to the Contractor) or otherwise in law.

Nothing in the Contract is intended to create the public, or any member thereof, as a third party beneficiary hereunder, nor is any term and condition or other provision of the Contract intended to establish a standard of care owed to the public or any member thereof.

Prior to the execution of this Agreement by the County, Contractor shall file certificates of insurance with the County Contracts/Purchasing Department and with the County Deputy Director of Public Works, Facilities and Parks, showing that the Contractor has in effect the insurance required by this Agreement. The Contractor shall file a new or amended certificate of insurance promptly after any change is made in any insurance policy that would alter the information of the certificate then on file. Acceptance or approval of insurance shall in no way modify or change the indemnification clause in this Agreement, which shall continue in full force and effect.

#### 7-1.08 WORKERS' COMPENSATION AND EMPLOYER'S LIABILITY INSURANCE:

Attention is directed to Section 7-1.06C, "Workers' Compensation and Employer's Liability Insurance," of the Standard Specifications.

## **SECTION 8 - PROSECUTION AND PROGRESS**

### **8-1.01 BEGINNING OF WORK, TIME OF COMPLETION AND LIQUIDATED DAMAGES:**

The Contractor shall begin work within 15 calendar days of the issuance of the Notice to Proceed by the County of Monterey.

This work shall be diligently prosecuted to completion before the expiration of **SIXTY (60) WORKING DAYS** beginning on the fifteenth calendar day after the date shown on the Notice to Proceed.

The Contractor shall pay to the County of Monterey the sum of **\$1,500 per day**, for each and every calendar days delay in finishing the work in excess of the number of working days prescribed above.

Attention is directed to the provisions in Section 8-1.04, "Start of Job Site Activities;" in Section 8-1.05 "Time", and in Section 8-1.10, "Liquidated Damages;" of the Standard Specifications and these Special Provisions.

### **8-1.02 PRE-CONSTRUCTION CONFERENCE:**

In lieu of Section 8-1.03, "Preconstruction Conference," of the Standard Specifications, insert the following:

A pre-construction conference will be held at the office of the MONTEREY COUNTY RESOURCE MANAGEMENT PUBLIC WORKS, FACILITIES & PARKS, 1441 SCHILLING PLACE, 2<sup>ND</sup> FLOOR, SALINAS, CALIFORNIA, 93901 where the Notice to Proceed will be issued and for the purpose of discussing with the Contractor the scope of work, Contract drawings, Specifications, existing conditions, materials to be ordered, equipment to be used, and all essential matters pertaining to the prosecution of and the satisfactory completion of the project as required. The Contractor's representatives at this conference shall include all major superintendents for the work and may include major subcontractors.

### **8-1.03 SCHEDULE:**

Comply with Section 8-1.02(C), "Level 2 Critical Path Method Schedule," of the Standard Specifications, unless otherwise authorized in writing by the Engineer.

The schedule software must be Microsoft Project 2010.

Full compensation for submitting the required schedules shall be considered as included in the contract prices paid for the various items of work involved, and no additional compensation shall be allowed therefor.

## **SECTION 9 – PAYMENT**

### **9-1.01 PROMPT PROGRESS PAYMENT TO SUBCONTRACTORS:**

Attention is directed to the provisions in Sections 10262 and 10262.5 of the Public Contract Code and Section 7108.5 of the Business and Professions Code concerning prompt payment to

subcontractors.

A prime contractor or subcontractor shall pay any subcontractor not later than seven (7) days of receipt of each progress payment in accordance with the provision in Section 7108.5 of the California Business and Professions Code concerning prompt payment to subcontractors. The seven (7) days is applicable unless a longer period is agreed to in writing. Any delay or postponement of payment over 30 days may take place only for good cause and with the agency's prior written approval. Any violation of Business and Professions Code Section 7108.5 shall subject the violating contractor or subcontractor to the penalties, sanction and other remedies of that section. This requirement shall not be construed to limit or impair any contractual, administrative, or judicial remedies otherwise available to the contractor or subcontractor in the event of a dispute involving late payment or nonpayment by the prime contractor, deficient subcontract performance, or noncompliance by a subcontractor.

This provision applies to both DBE and non-DBE subcontractors.

9-1.02 PAYMENT ADJUSTMENTS FOR PRICE INDEX FLUCTUATIONS:

Attention is directed to the requirements specified in Section 9-1.07, "Payment Adjustments for Price Index Fluctuations," of the Standard Specifications and these Special Provisions.

For the California statewide crude oil price index, go to:

<http://www.dot.ca.gov/hq/construc/crudeoilindex/>

This section does not apply if you opted out of Payment Adjustment for Price Index Fluctuations at the time of bid opening. A form is provided in the Bid Form.

9-1.03 PROGRESS PAYMENTS AND PAYMENTS AFTER CONTRACT ACCEPTANCE:

Attention is directed to Section 9-1.16, "Progress Payments," and 9-1.17 "Payment After Contract Acceptance," of the Standard Specifications and these special provisions.

In lieu of Section 9-1.16F, "Retentions," of the Standard Specifications, the following shall be inserted:

Progress payment shall not be made in excess of 95% of the actual work completed. County shall withhold five (5) percent from progress payment until final completion and acceptance of the project by the Board of Supervisors.

In lieu of Section 9-1.16C, "Materials On Hand," of the Standard Specifications, the following shall be inserted:

No progress payment will be made for any materials on hand which are furnished but not incorporated in the work.

9-1.04 ARBITRATION:

Section 9-1.22, "Arbitration," as defined in the Standard Specifications, is deleted from this contract. In lieu of arbitration, the following shall apply (from the Public Contract Code):

A. Application of article; inclusion of article in plans and specifications (Public Contracts Codes 20104):

- 1a. This article applies to all public works claims of three hundred seventy-five thousand dollars (\$375,000) or less which arise between a Contractor and the County of Monterey.
- 1b. This article shall not apply to any claims resulting from a contract between the Contractor and the County of Monterey when the public agency has elected to resolve any disputes pursuant to Article 7.1 (commencing with Section 10240) of Chapter 1 of Part 2, of the Public Contract Code).
- 2a. "Public Work" has the same meaning as in Section 1101 of the Public Contract Code but does not include any work or improvement contracted for by the state or the Regents of the University of California.
- 2b. "Claim" means a separate demand by the Contractor for (A) a time extension, (B) payment of money or damages arising from work done by or on behalf of the Contractor pursuant to the contract for a public work and payment of which is not otherwise expressly provided for or the claimant is not otherwise entitled to, or (C) an amount the payment of which is disputed by the local agency.
3. The provisions of this article or a summary thereof shall be set forth in the plans or specifications for any work which may give rise to a claim under this article.
4. This article applies only to contracts entered into on or after January 1, 1991.

B. Claims; requirements (Public Contracts Code Section 20104.2):

For any claim subject to this article, the following requirements apply:

1. The claim shall be in writing and include the documents necessary to substantiate the claim. Claims must be filed on or before the date of final payment. Nothing in this subdivision is intended to extend the time limit or supersede notice requirements otherwise provided by contract for the filing of claims.
- 2a. For Claims of less than fifty thousand dollars (\$50,000), the local agency shall respond in writing to any written claim within 45 days of receipt of the claim, or may request, in writing, within 30 days of receipt of the claim, any additional documentation supporting the claim or relating to defenses or claims the local agency may have against the claimant.
- 2b. If additional information is thereafter required, it shall be requested and provided pursuant to this subdivision, upon mutual agreement of the local agency and the claimant.
- 2c. The local agency's written response to the claim, as further documented, shall be submitted to the claimant within 15 days after receipt of the further documentation or



within a period of time no greater than that taken by the claimant in producing the additional information, whichever is greater.

- 3a. For claims of over fifty thousand dollars (\$50,000) and less than or equal to three hundred seventy-five thousand dollars (\$375,000), the local agency shall respond in writing to all written claims within 60 days of receipt of the claim, or may request, in writing, within 30 days of receipt of the claim, any additional documentation supporting the claim or relating to defenses or claims the local agency may have against the claimant.
- 3b. If additional information is thereafter required, it shall be requested and provided pursuant to this subdivision, upon mutual agreement of the local agency and the claimant.
- 3c. The local agency's written response to the claim, as further documented, shall be submitted to the claimant within 30 days after receipt of the further documentation, or within a period of time no greater than that taken by the claimant in producing the additional information or requested documentation, whichever is greater.
4. If the claimant disputes the local agency's written response, or the local agency fails to respond within the time prescribed, the claimant may so notify the local agency, in writing, either within 15 days of receipt of the local agency's response or within 15 days of the local agency's failure to respond within the time prescribed, respectively, and demand an informal conference to meet-and-confer for settlement of the issues in dispute. Upon a demand, the local agency shall schedule a meet-and-confer conference within 30 days for settlement of the dispute.
5. If following the meet-and-confer conference the claim or any portion remains in dispute, the claimant may file a claim pursuant to Chapter 1 (commencing with Section 900) and Chapter 2 (commencing with Section 910) of Part 3 of Division 3.6 of Title 1 of the Government Code. For purposes of those provisions, the running of the period of time within which a claim must be filed shall be tolled from the time the claimant submits his or her written claim pursuant to Section 915(a) of the Government Code until the time the claim is denied, including any period of time utilized by the meet and confer conference.

C. Procedures for civil actions filed to resolve claims (Public Contracts Codes 20104.4):

The following procedures are established for all civil actions filed to resolve claims subject to this article:

1. Within 60 days, but no earlier than 30 days, following the filing or responsive pleadings, the court shall submit the matter to nonbinding mediation unless waived by mutual stipulation of both parties. The mediation process shall provide for the selection within 15 days by both parties of a disinterested third person as mediator, shall be commenced within 30 days of the submittal, and shall be concluded within 15 days from the commencement of the mediation unless a time requirement is extended upon a good cause showing to the court.

2a. If the matter remains in dispute, the case shall be submitted to judicial arbitration pursuant to Chapter 2.5 (commencing with Section 1141.10) Title 3 of Part 3 of the Code of Civil Procedure, notwithstanding Section 1141.11 of that code. The Civil Discovery Act of 1986 Article 3 (commencing with Section 2016) of Chapter 3 of Title 3 of Part 4 of the Code of Civil Procedure) shall apply to any proceeding brought under this subdivision consistent with the rules pertaining to judicial arbitration.

2b. In addition to Chapter 2.5 (commencing with Section 1141.10) of Title 3 of Part 3 of the Code of Civil Procedure, (A) arbitrators shall, when possible, be experienced in construction law, and (B) any party appealing an arbitration award who does not obtain a more favorable judgment shall, in addition to payment of costs and fees under that chapter, also pay the attorney's fees on appeal of the other party.

D. Payment by local agency of undisputed portion of claim; interest on arbitration award or judgment (Public Contracts Codes 2104.6):

1. The County of Monterey shall not fail to pay money as to any portion of a claim that is undisputed except as otherwise provided in the contract.
2. In any suit filed under Section 20104.4, Monterey County shall pay interest at the legal rate on any arbitration award or judgment. The interest shall begin to accrue the date the suit is filed in a court of law.

## **SECTION 10 – GENERAL**

### **10-1.01 WORK SEQUENCING:**

Attention is directed to "Water Pollution Control" of these special provisions regarding the submittal and approval of the Storm Water Pollution Prevention Plan prior to performing work having potential to cause water pollution.

Prior to applying slurry seal, the Contractor shall cover all manholes, valve and monument covers, grates, or other exposed facilities located within the area of application, using a plastic or oil resistant construction paper secured to the facility being covered by tape or adhesive. The covered facilities shall be referenced by the Contractor, with a sufficient number of control points to relocate the facilities after the slurry seal has been placed. After completion of the slurry seal operation, all covers shall be removed and disposed of in a manner satisfactory to the Engineer. Full compensation for covering manholes, valve and monument covers, grates, or other exposed facilities, referencing, and removing temporary cover shall be considered as included in the contract price paid per ton for the item of work involved, and no additional compensation will be allowed therefor.

**Clean the pavement and ensure it is free of dust, mud, dirt, debris, or extraneous material IMMEDIATELY before applying slurry seal, tack coat, hot mix asphalt, and striping. Cleaning the pavement and maintaining it clean prior to these activities is included in the**

**contract price paid for the various contract items of work.**

## **SECTION 12 TEMPORARY TRAFFIC CONTROL**

### **12-1.01 FLAGGING COSTS:**

Replace Section 12-1.04, "Payment," of the Standard Specifications the following with:

The cost of furnishing all flaggers, including transporting flaggers, to provide for passage of public traffic through the work under provisions in Sections 7-1.03, "Public Convenience," and 7-1.04, "Public Safety," of the Standard Specifications and for providing stands or towers for use of flaggers is included in the price paid for Traffic Control System.

### **12-1.02 PORTABLE CHANGEABLE MESSAGE SIGN:**

Portable changeable message signs shall be furnished, placed, operated, and maintained at locations designated by the Engineer and shall conform to the provisions in Section 12-3, "Temporary Traffic Control Devices," of the Standard Specifications and these special provisions. Messages displayed on the portable changeable message signs shall conform to Section 12-3.32 "Portable Changeable Message Signs," of the Standard Specifications and Section 12-1.05, "Maintaining Traffic," of these special provisions."

Start displaying the message on the portable changeable message sign 30 minutes before closing the lane.

Place the portable changeable message sign in advance of the 1st warning sign for each:

1. Stationary lane closure
2. Shoulder closure

Seven (7) calendar days prior to the start of work, portable changeable message signs shall be placed at minimum, at both begin and end limits of construction, warning the public of expected delays due to construction activities, as directed by the Engineer.

Full compensation for furnishing all labor, materials, tools, equipment, and incidentals, and for doing all the work involved in furnishing, placing, operating, maintaining, repairing, transporting from location to location and removing the portable changeable message sign, as shown on the plans, as specified in the Standard Specifications and these special provisions, and as directed by the Engineer shall be considered as included in the contract lump sum price paid for traffic control system.

### **12-1.03 IMPACT ATTENUATOR VEHICLE:**

Replace Section 12-3.23A(1), "Summary," of the Standard Specifications with:

Section 12-3.23 includes specifications for protecting traffic and workers with an impact attenuator vehicle during moving lane closures and when placing and removing components of stationary lane closures, ramp closures, shoulder closures, or a combination.

Insert the following in Section 12-3.23D, "Payment" of the Standard Specifications:

The cost for impact attenuator vehicle is included in the contract lump sum price paid for traffic control system.

12-1.05 MAINTAINING TRAFFIC:

Maintaining traffic shall conform to the provisions in Section 7-1.03, "Public Convenience," Section 7-1.04, "Public Safety," and Section 12-4, "Maintaining Traffic," of the Standard Specifications.

Closures shall conform to the provisions in Section 12-1.05, "Traffic Control System for Lane Closure," of these special provisions.

CLOSURE REQUIREMENTS

Closures are only allowed during the hours shown in the lane requirement charts included in this section "Maintaining Traffic," except for work required under Sections 7-1.03, "Public Convenience," and Section 7-1.04, "Public Safety" of the Standard Specifications.

The full width of the traveled way shall be open for use by public traffic when construction operations are not actively in progress.

Under one-way reversing traffic control operations, public traffic may be stopped in one direction for periods not to exceed 10 minutes.

Personal vehicles of the Contractor's employees shall not be parked on the traveled way or shoulders including sections closed to public traffic.

When work vehicles or equipment are parked on the shoulder within six (6) feet of a traffic lane, the shoulder area shall be closed with fluorescent orange traffic cones or portable delineators placed on a taper in advance of the parked vehicles or equipment and along the edge of the pavement at 25-foot intervals to a point not less than 25 feet past the last vehicle or piece of equipment. A minimum of nine (9) traffic cones or portable delineators shall be used for the taper. A W20-1 (ROAD WORK AHEAD) or W21-5b (RIGHT/LEFT SHOULDER CLOSED AHEAD) or C24(CA) (SHOULDER WORK AHEAD) sign shall be mounted on a crashworthy portable sign support with flags. The sign shall be placed where designated by the Engineer. The sign shall be a minimum of 48" x 48" in size. The Contractor shall immediately restore to the original position and location a traffic cone or delineator that is displaced or overturned, during the progress of work.

If minor deviations from the lane requirement charts are required, a written request shall be submitted to the Engineer at least 15 days before the proposed date of the closure. The Engineer may approve the deviations if there is no significant increase in the cost to the State and if the work can be expedited and better serve the public traffic.

Full compensation for furnishing, erecting, maintaining, and removing and disposing of the

W20-1, W21-5b, and C24(CA) signs shall be considered as included in the contract price paid for the items of work and no additional compensation will be allowed therefore.

**CLOSURE SCHEDULE**

<b>Chart No. 1 Conventional Highway Lane Requirements</b>																							
County: Monterey							Route/Direction: Salinas Road/ EB and WB							MP: 9.07 to MP 12.20									
Closure Limits: From 0.5 mi west of Fruitland Ave to Elkhorn Ave																							
FROM HOUR TO HOUR      24 01 02 03 04 05 06 07 08 09 10 11 12 13 14 15 16 17 18 19 20 21 22 23 24																							
Mondays through Fridays																							
Saturdays																							
Sundays																							
Legend:																							
<input type="checkbox"/> R Closure with reversible control permitted.																							
<input type="checkbox"/> No closure permitted.																							
REMARKS: Use of shoulder as through traffic lane as approved by the Engineer. Through traffic lanes shall be a minimum width of 11 feet.																							

For operations requiring lane closure, submit the contingency plan and discuss with the Engineer at least five (5) business days before starting that operation. Submit any revisions to the contingency plan for an operation at least five (5) business days before starting that operation. Do not close any lanes until the contingency plan has been authorized.

12-1.06 TRAFFIC CONTROL SYSTEM FOR LANE CLOSURE:

Replace Section 12-5, “Traffic Control System for Lane Closure,” of the Standard Specifications with:

**GENERAL**

This section includes specifications for closing traffic lanes with stationary and moving lane closures on 2-lane, 2-way highways. The traffic control system for a lane closure must comply with the details shown.

Traffic control system includes signs.

**MATERIALS**

Vehicles equipped with attenuators must comply with section 12-1.03, “Impact Attenuator Vehicle,” of these special provisions.

A new attenuator that is proposed as equal to the authorized attenuators or attenuators ordered for recertification must not be used until authorized by the Engineer.

## CONSTRUCTION

### General

During traffic striping and pavement marker placement using bituminous adhesive, control traffic with a stationary or a moving lane closure. During other activities, control traffic with stationary lane closures.

Whenever components of the traffic control system are displaced or cease to operate or function as specified from any cause, immediately repair the components to the original condition or replace the components and restore the components to the original location.

### Stationary Lane Closures

For a stationary lane closure made only for the work period, remove components of the traffic control system from the traveled way and shoulder, except for portable delineators placed along open trenches or excavation adjacent to the traveled way at the end of each work period. You may store the components at selected central locations designated by the Engineer within the limits of the highway.

For multilane highway lane closures, each vehicle used to place, maintain, and remove components of a traffic control system on a multilane highway must be equipped with a Type II flashing arrow sign that must be in operation whenever the vehicle is being used for placing, maintaining, or removing the components. Vehicles equipped with a Type II flashing arrow sign not involved in placing, maintaining or removing the components if operated within a stationary-type lane closure must only display the caution display mode. The sign must be controllable by the operator of the vehicle while the vehicle is in motion. If a flashing arrow sign is required for a lane closure, the flashing arrow sign must be operational before the lane closure is in place.

Use a pilot car to control traffic as ordered by the engineer. The pilot car must have radio contact with personnel in the work area. Operate the pilot car through the traffic control zone at a speed not greater than 25 miles per hour.

### Moving Lane Closures

A changeable message sign used in a moving lane closure must comply with section 12-1.02, "Portable Changeable Message Sign," of these special provisions except the sign must be truck-mounted. The full operational height to the bottom of the sign may be less than seven (7) feet above the ground but must be as high as practicable.

A flashing arrow sign used in a moving lane closure must be truck-mounted. Operate the flashing arrow sign in the caution display mode whenever it is being used on a 2-lane, 2-way highway.

## PAYMENT

Traffic control system for lane closure is paid for as traffic control system. Flagging costs are paid for as specified in section 12-1.01, "Flagging Costs," of these special provisions.

A traffic control system required by change order work is paid for as a part of the change order work.

## **SECTION 17 – CLEARING AND GRUBBING**

### **17-1.01 CLEARING AND GRUBBING:**

Add after Item 5 in section 17-2.03A:

6. five (5) feet outside edge of pavement and/or asphalt concrete dike
7. four (4) feet around and the length of drainage structures including overside drains

**APPENDIX I - SAMPLE CONTRACT**

SAMPLE AGREEMENT

CONTRACT FOR PUBLIC WORK

COUNTY OF MONTEREY

STATE OF CALIFORNIA

PROJECT NO. 1166

THIS AGREEMENT, is made in triplicate by and between the COUNTY OF MONTEREY, a political subdivision of the State of California, hereinafter called the "County," and \_\_\_\_\_, hereinafter called the "Contractor," (collectively referred to as "the parties").

WITNESSETH:

(1) THE WORK

The Contractor shall do all the work and furnish all the materials, except such as are mentioned in any of the Contract documents to be furnished by the County, necessary to construct and complete in a good, workmanlike and substantial manner and to the satisfaction of the County, the following public work:

ELKHORN RD / WERNER RD / SALINAS RD  
INTERSECTION SAFETY IMPROVEMENT - PHASE 1  
PROJECT NO. 1166

in accordance with this agreement and with all of the following additional Contract documents which are incorporated into and made a part of this AGREEMENT:

- (a) The Standard Specifications 2018, and the Standard Plans 2018, including issued revision, of the State of California, Department of Transportation.
- (b) A set of plans and cross sections (when applicable) entitled:

PROJECT PLANS FOR CONSTRUCTION ON  
SALINAS RD, FROM 0.5 MI WEST OF FRUITLAND AVE TO ELKHORN AVE, NEAR LAS  
LOMAS



PROJECT NO. 1166

- (c) The Special Provisions for the work.
- (d) The Notice to Bidders calling for bids.
- (e) The Payment and Performance bonds.
- (f) Certificate of Insurance.
- (g) The accepted bid/proposal including the following:
  - (1) List of Subcontractors
  - (2) Equal Employment Opportunity Certification
  - (3) Public Contract Code
    - Section 10285.1 Statement
    - Section 10162 Questionnaire
    - Section 10232 Statement
  - (4) Noncollusion Declaration
  - (5) Debarment and Suspension Certification
  - (6) Statement Concerning Employment Of Undocumented Aliens
  - (7) Contractor's Certificate As To Workers' Compensation
  - (8) Waiver for Payment Adjustments for Price Index Fluctuations
  - (9) Contractor's Certification of Good Faith Effort to Employ Monterey Bay Area Residents
  - (10) List of Satisfied Public Agencies
  - (11) Bidder's Bond

All Contract documents are intended to cooperate, so that any work called for in one (1) and not mentioned in another is to be executed the same as if mentioned in all. However, should there be any conflict between the terms of this instrument and the Contractor's bid or proposal, then this AGREEMENT shall control.

2. WORKERS' COMPENSATION

In accordance with the provisions of Section 3700 of the Labor Code, the Contractor and every Subcontractor will be required to secure the payment of compensation to his/her/its employees.

3. CONTRACT PRICE

The County shall pay the Contractor the following prices for the performance of this Contract:

ELKHORN RD / WERNER RD / SALINAS RD

ELKHORN RD / WERNER RD / SALINAS RD  
INTERSECTION SAFETY IMPROVEMENT - PHASE 1  
PROJECT NO. 1166

INTERSECTION SAFETY IMPROVEMENT - PHASE 1  
PROJECT NO. 1166

Item No.	Item Code	FS	Description	Unit	Quantity	Unit Price (in Figures)	Item Total (in Figures)
1	120100		Traffic Control System	LS	1	\$ 110,000.00	\$ 110,000.00
2	377501		Slurry Seal	TON	182	\$ 390.00	\$ 70,980.00
3	810230		Pavement Marker (Retroreflective)	EA	384	\$ 8.75	\$ 3,360.00
4	820250		Remove Roadside Sign	EA	4	\$ 125.00	\$ 500.00
5	820590		Relocate Roadside Sign-One Post	EA	3	\$ 309.75	\$ 929.25
6	820840		Roadside Sign-One Post	EA	14	\$ 335.00	\$ 4,690.00
7	840501		Thermoplastic Traffic Stripe	LF	28061	\$ 0.85	\$ 23,851.85
8	840515		Thermoplastic Pavement Marking	SQFT	1211	\$ 7.85	\$ 9,506.35
9	846030		Remove Thermoplastic Traffic Stripe	LF	19382	\$ 0.50	\$ 9,691.00
10	846035		Remove Thermoplastic Pavement Marking	SQFT	572	\$ 3.00	\$ 1,716.00
11			Pavement Marking (Green Paint)	SQFT	3082	\$ 4.00	\$ 12,328.00
<b>TOTAL COST</b>						<b>\$ 247,552.45</b>	

F – Final Pay Item  
S – Specialty Item

#### 4. PUBLIC WORKS CONTRACT

The parties to this Agreement understand and agree that this is a Public Works Contract pursuant to California Public Contract Code Section 7103.5 which states,

(a) As used in this section:

(1) "Public works contract" means a contract awarded through competitive bids by the state or any of its political subdivisions or public agencies, on whose behalf the Attorney General may bring an action pursuant to subdivision (c) of Section 16750 of the Business and Professions Code, for the erection, construction, alteration, repair, or improvement of any structure, building, road, or other improvement of any kind.

(2) "Awarding body" means the state or the subdivision or agency awarding a public works contract.

(b) In entering into a public works contract or a subcontract to supply goods, services, or materials pursuant to a public works contract, the contractor or subcontractor offers and agrees to assign to the awarding body all rights, title, and interest in and to all causes of action it may have under Section 4 of the Clayton Act (15 U.S.C. Sec. 15) or under the Cartwright Act (Chapter 2 (commencing with Section 16700) of Part 2 of Division 7 of the Business and Professions Code), arising from purchases of goods, services, or materials pursuant to the public works contract or the subcontract. This assignment shall be made and become effective at the time the awarding body tenders final payment to the contractor, without further acknowledgment by the parties.

(c) Subdivision (b) shall be included in full in the specifications for the public works contract or in the general provisions incorporated therein and shall be included in full in the public works contract or in the general provisions incorporated therein.

IN WITNESS WHEREOF, the parties hereto have executed this AGREEMENT as of the last date appearing below their respective signatures.

**CONTRACTOR:**

\_\_\_\_\_  
(Name of Company)

By: \_\_\_\_\_  
Corp: Signature of Chair, President, or Vice-President  
LLC: Signature of Manager

By: \_\_\_\_\_  
Corp: Signature of Secretary, Asst. Secretary, CFO,  
Treasurer or Asst. Treasurer  
LLC: Signature of Manager

\_\_\_\_\_  
Printed Name

\_\_\_\_\_  
Printed Name

Its: \_\_\_\_\_  
Title

Its: \_\_\_\_\_  
Title

Date: \_\_\_\_\_

Date: \_\_\_\_\_

**COUNTY OF MONTEREY:**

APPROVED AS TO FISCAL TERMS

By: \_\_\_\_\_  
Name: \_\_\_\_\_  
Title: of Public Works, Facilities & Parks  
Dated: \_\_\_\_\_

By: \_\_\_\_\_  
Name: Gary Giboney  
Title: Chief Deputy Auditor-Controller  
Date: \_\_\_\_\_

APPROVED AS TO FORM

APPROVED AS TO INDEMNITY/  
INSURANCE LANGUAGE

By: \_\_\_\_\_  
Name: Mary Grace Perry  
Title: Deputy County Counsel  
Date: \_\_\_\_\_

By: \_\_\_\_\_  
Name: Leslie J. Girard  
Title: County Counsel-Risk Manager  
Date: \_\_\_\_\_

**\*INSTRUCTIONS:** If CONTRACTOR is a corporation, including non-profit corporations, the full legal name of the corporation shall be set forth above together with the signatures of two (2) specified officers per California Corporations Code Section 313. If CONTRACTOR is a Limited Liability Corporation (LLC), the full legal name of the LLC shall be set forth above together with the signatures of two (2) managers. If CONTRACTOR is a partnership, the name of the partnership shall be set forth above together with the signature of a partner who has authority to execute this AGREEMENT on behalf of the partnership. If CONTRACTOR is contracting in an individual capacity, the individual shall set forth the name of the business, if any, and shall personally sign the AGREEMENT.

COUNTY OF MONTEREY

PAYMENT BOND

(Civil Code Section 9550)

WHEREAS, the County of Monterey has awarded to Principal, as Contractor, a Contract for the following project:

ELKHORN RD / WERNER RD / SALINAS RD  
INTERSECTION SAFETY IMPROVEMENT - PHASE 1  
PROJECT NO. 1166

AND WHEREAS, Principal, as Contractor, is required to furnish a bond in connection with said Contract, to secure the payment of claims of laborers, mechanics, materialmen, and other persons furnishing labor and materials on the project, as provided by law.

NOW, THEREFORE, we \_\_\_\_\_, as Principal, and \_\_\_\_\_ as Surety, are held and firmly bound unto the County of Monterey, a political subdivision of the State of California (hereinafter called "County"), and to the persons named in California Civil Code section 9100 in the penal sum of \_\_\_\_\_ Dollars (\$ \_\_\_\_\_) for the payment of which sum in lawful money of the United States, well and truly to be made, we bind ourselves, our heirs, executors, administrators, successors and assigns, jointly and severally, firmly by these presents.

THE CONDITION OF THIS OBLIGATION IS SUCH THAT:

If the Principal, or any of Principal's heirs, executors, administrators, successors, assigns, or Subcontractors, (1) fails to pay in full all of the persons named in Civil Code Section 9100 with respect to any labor or materials furnished by said persons on the project described above, or (2) fails to pay in full all amounts due under the California Unemployment Insurance Code with respect to work or labor performed on the project described above, or (3) fails to pay for any amounts required to be deducted, withheld, and paid over to the Employment Development Department from the wages of employees of the Principal and Subcontractors pursuant to Unemployment Insurance Code Section 13020 with respect to such work and labor, then the Surety shall pay for the same.

Surety hereby stipulates and agrees that no change, extension of time, alteration or addition to the terms of the Contract on the call for bids, or to the work to be performed there under, or the specifications accompanying the same, shall in any way affect its obligation under this bond, and it does hereby waive notice of any such change, extension of time, alteration or addition to the terms of said Contract or the call for bids, or to the work, or to the specifications.

If suit is brought upon this bond by the County and judgment is recovered, the Surety shall pay all litigation expenses incurred by the County in such suit, including attorney's fees,

court costs, expert witness fees and investigation expenses.

This bond inures to the benefit of any of the persons named in Civil Code Section 9100, and such persons or their assigns shall have a right of action in any suit brought upon this bond, subject to any limitations set forth in Civil Code Sections 9550 et seq. (Civil Code, Division 4, Part 6, Title 3, Chapter 5: Payment Bond for Public Works & Facilities).

IN WITNESS WHEREOF the above bounden parties have executed this instrument under their several seals this \_\_\_\_\_ day of \_\_\_\_\_, 20\_\_\_\_, the name and corporate seal of each corporate party being hereto affixed and these presents duly signed by its undersigned representative, pursuant to authority of its governing body.

(Corporate Seal)

\_\_\_\_\_  
Principal

By \_\_\_\_\_

Name and Title \_\_\_\_\_

(Corporate Seal)

\_\_\_\_\_  
Surety

By \_\_\_\_\_

Name and Title \_\_\_\_\_

(Attach notary acknowledgement for all signatures and original or certified copy of unresolved appointment, attorney-in-fact certificate, power of attorney, by laws, or other instrument entitling or authorizing person executing bond on behalf of Surety to do so.)

COUNTY OF MONTEREY

PERFORMANCE BOND

WHEREAS, the County of Monterey has awarded to Principal, \_\_\_\_\_ as Contractor, a Contract for the following project:

ELKHORN RD / WERNER RD / SALINAS RD  
INTERSECTION SAFETY IMPROVEMENT - PHASE 1  
PROJECT NO. 1166

WHEREAS, Principal, as Contractor, is required to furnish a bond in connection with said Contract, to secure the faithful performance of said Contract.

NOW, THEREFORE, we \_\_\_\_\_, as Principal, and \_\_\_\_\_ as Surety, are held and firmly bound unto the County of Monterey, a political subdivision of the State of California (hereinafter called "County"), in the penal sum of \_\_\_\_\_ Dollars (\$ \_\_\_\_\_), for the payment of which sum in lawful money of the United States, well and truly to be made, we bind ourselves, our heirs, executors, administrators, successors and assigns, jointly and severally, firmly by these presents.

THE CONDITION OF THIS OBLIGATION IS SUCH THAT:

If the Principal, as Contractor, or Principal's heirs, executors, administrators, successors, or assigns, (1) shall in all things stand to and abide by and well and truly keep and perform the covenants, conditions, and agreements in said Contract and any alteration thereof made as therein provided, on Principal's part to be kept and performed, at the time and in the manner therein specified and in all respects according to their true intent and meaning, and (2) shall defend, indemnify and save harmless the County, the members of its board of supervisors, and its officers, agents and employees as therein stipulated, then this obligation shall become null and void; otherwise, it shall be and remain in full force and virtue.

Surety hereby stipulates and agrees that no change, extension of time, alteration, or addition to the terms of the Contract or the call for bids, or to the work to be performed thereunder, or the specifications accompanying the same, shall in any way affect its obligation under this bond, and it does hereby waive notice of any such change, extension of time, alteration or addition to the terms of said Contract or the call for bids, or to the work, or to the specifications.

Whenever the Principal, as Contractor, is in default, and is declared in default, under the Contract by the County of Monterey, the County of Monterey having performed its obligation under the Contract, Surety may promptly remedy the default, or shall promptly:

- (1) Complete the Contract in accordance with its terms or conditions, or
- (2) Obtain a bid or bids for submission to County of Monterey for completing the

Contract in accordance with its terms or conditions, and upon determination by County of Monterey and Surety of the lowest responsible and responsive bidder, arrange for a Contract between such bidder and County of Monterey, and make available as work progresses (even though there should be a default or a succession of defaults under the Contract or Contracts of completion arranged under this paragraph) sufficient funds to pay the cost of completion less the balance of Contract price.

If suit is brought upon this bond by the County and judgment is recovered, the Surety shall pay all litigation expenses incurred by the County in such suit, including attorney's fees, court costs, expert witness fees and investigation expenses.

IN WITNESS WHEREOF, the above bounden parties have executed this instrument under their several seals this \_\_\_\_\_ day of \_\_\_\_\_, 20\_\_\_\_, the name and corporate seal of each corporate party being hereto affixed and these presents duly signed by its undersigned representative, pursuant to authority of its governing body.

(Corporate Seal)

\_\_\_\_\_  
Principal

By \_\_\_\_\_

Name and Title \_\_\_\_\_

(Corporate Seal)

\_\_\_\_\_  
Surety

By \_\_\_\_\_

Name and Title \_\_\_\_\_

(Attach notary acknowledgement for all signatures and original or certified copy of unresolved appointment, attorney-in-fact certificate, power of attorney, by laws, or other instrument entitling or authorizing person executing bond on behalf of Surety to do so.)



**MONTEREY COUNTY  
RESOURCE MANAGEMENT AGENCY**

**PUBLIC WORKS**

COUNTY CLERK OF THE BOARD OF SUPERVISORS  
168 W. ALISAL STREET, 1<sup>ST</sup> FLR,  
SALINAS, CALIFORNIA 93901



**BOOK TWO**

**BID FORM**

**ELKHORN RD / WERNER RD / SALINAS RD  
INTERSECTION SAFETY IMPROVEMENT - PHASE 1  
PROJECT NO. 1166**

**NAME OF BIDDER** \_\_\_\_\_

**BUSINESS P.O. BOX** \_\_\_\_\_

**CITY, STATE, ZIP** \_\_\_\_\_

**BUSINESS STREET ADDRESS** \_\_\_\_\_

*(Please include even if P.O. Box used)*

**CITY, STATE, ZIP** \_\_\_\_\_

**TELEPHONE NO:**      **AREA CODE (    )** \_\_\_\_\_

**FAX NO:**              **AREA CODE (    )** \_\_\_\_\_

**CONTRACTOR LICENSE NO.** \_\_\_\_\_

APPROVED AS TO FORM:

*Mary Grace Perry*

MARY GRACE PERRY  
Deputy County Counsel

*9-2-2020*



**BOOK TWO  
BID/PROPOSAL**

**ELKHORN RD / WERNER RD / SALINAS RD  
INTERSECTION SAFETY IMPROVEMENT - PHASE 1  
PROJECT NO. 1166**

**TABLE OF CONTENTS**

	Page No.
BID FORM.....	4
LIST OF SUBCONTRACTORS.....	10
EQUAL EMPLOYMENT OPPORTUNITY CERTIFICATION .....	13
PUBLIC CONTRACT CODE.....	14
NONCOLLUSION DECLARATION.....	16
DEBARMENT AND SUSPENSION CERTIFICATION.....	17
STATEMENT CONCERNING EMPLOYMENT OF UNDOCUMENTED ALIENS .....	18
CONTRACTOR'S CERTIFICATE AS TO WORKER'S COMPENSATION .....	19
WAIVER FOR PAYMENT ADJUSTMENT FOR PRICE INDEX FLUCTUATIONS.....	20
CONTRACTOR'S CERTIFICATION OF GOOD-FAITH EFFORT TO EMPLOY MONTEREY BAY AREA RESIDENTS.....	21
LIST OF SATISFIED PUBLIC AGENCIES .....	23
BIDDER'S BOND.....	24

**BID FORM**

**ELKHORN RD / WERNER RD / SALINAS RD  
INTERSECTION SAFETY IMPROVEMENT - PHASE 1  
PROJECT NO. 1166**

TO: MONTEREY COUNTY BOARD OF SUPERVISORS  
Government Center  
168 W. Alisal Street, 1<sup>st</sup> Floor, Room 1032  
Salinas, California 93901-2683

1. Pursuant to and in compliance with the Notice to Bidders Inviting Formal Bids and with the other documents relating thereto, the undersigned bidder, having become familiar with the terms of the contract, the local conditions affecting the performance of the contract, the cost of the work at the place where the work is to be done, the project plans and specifications, and the other contract documents, hereby proposes and agrees to perform within the time hereinafter set forth the said Specifications and shown on the plans accompanying them, and to provide and furnish any and all labor, materials, equipment, transportation, utilities, and services necessary to perform the contract and complete in a workmanlike manner all of the work required in connection with the following project: ELKHORN RD / WERNER RD / SALINAS RD INTERSECTION SAFETY IMPROVEMENT - PHASE 1, all in strict conformity with the specifications and other contract documents, including all addenda for the sum hereinafter stated:

ELKHORN RD / WERNER RD / SALINAS RD  
INTERSECTION SAFETY IMPROVEMENT - PHASE 1  
PROJECT NO. 1166

BID:

Item No.	Item Code	FS	Description	Unit	Quantity	Unit Price (in Figures)	Item Total (in Figures)
1	120100		Traffic Control System	LS	1		
2	377501		Slurry Seal	TON	182		
3	810230		Pavement Marker (Retroreflective)	EA	384		
4	820250		Remove Roadside Sign	EA	4		
5	820590		Relocate Roadside Sign-One Post	EA	3		
6	820840		Roadside Sign-One Post	EA	14		
7	840501		Thermoplastic Traffic Stripe	LF	28061		
8	840515		Thermoplastic Pavement Marking	SQFT	1211		
9	846030		Remove Thermoplastic Traffic Stripe	LF	19382		
10	846035		Remove Thermoplastic Pavement Marking	SQFT	572		

Item No.	Item Code	FS	Description	Unit	Quantity	Unit Price (in Figures)	Item Total (in Figures)
11			Pavement Marking (Green Paint)	SQFT	3082		
<b>TOTAL BID</b>							

F – Final Pay Item  
S – Specialty Item

2. Bids are required for the entire work. The undersigned understands that the quantities given are approximate only, being given as a basis for the comparison of Bids, and the County of Monterey does not, expressly or by implication, agree that the actual amount of work shall correspond therewith, but reserves the right to increase or decrease the amount of any portion of the work, or to omit portions of the work, as may be deemed necessary without claim for damage or loss of anticipated profit and that payment shall be made only on the basis of the actual quantities of work performed.

The bidder shall set forth for each unit basis item of work a unit price and a total for the item, and for each lump sum item a total for the item, all in clearly legible figures in the respective spaces provided for that purpose. In the case of unit basis items, the amount set forth under the "Item Total" column shall be the product of the unit price bid and the estimated quantity for the item.

The basis of award to the lowest responsive, responsible bidder will be the lowest TOTAL BID.

The bid submitted must not contain erasures, interlineations, or other corrections unless each such correction is suitably authenticated by affixing in the margin immediately opposite the correction the surname or surnames of the person or persons signing the bid, in the named person's own handwriting.

In case of discrepancy between the unit price and the item total price set forth for the item, the unit price shall prevail; provided, however, if the amount set forth as the unit price is ambiguous, unintelligible or uncertain for any cause, or is omitted, the amount set forth in the "Item Total" column for the item shall prevail in accordance with the following:

- (1) As to lump sum items, the amount set forth in the "Item Total" column shall be the unit price.
- (2) As to unit basis items, the amount set forth in the "Item Total" column shall be divided by the estimated quantity for the item, and the price thus obtained shall be the unit price.

3. The undersigned has checked all of the above figures carefully and understands that the County of Monterey (also referred to herein as "Owner") will not be responsible for any errors and omissions on the part of the undersigned in making this bid.

Symbols such as commas and dollar signs will be ignored and have no mathematical significance in establishing any unit price or item total or lump sums. Written unit prices, item totals and lump sums will be interpreted according to the number of digits and, if applicable, decimal placement. Cents symbols also have no significance in establishing any unit price or item total since all figures are assumed to be expressed in dollars and/or decimal fractions of a dollar.

The foregoing provisions for the resolution of specific irregularities cannot be so comprehensive as to cover every omission, inconsistency, error or other irregularity which may occur in a bid. Any situation not specifically provided for will be determined in the discretion of the Owner, and that discretion will be exercised in the manner deemed by the Owner to best protect the public interest in the prompt and economical completion of the work. The decision of the Owner respecting the amount of a bid, or the existence or treatment of an irregularity in a bid, shall be final.

4. It is understood that the Owner reserves the right to reject any and all bids or waive any irregularities or informalities in the bidding.
5. This bid shall remain valid and will not be withdrawn by the undersigned bidder for a period of ninety (90) days from the date prescribed for opening of this bid.
6. Attached hereto are the following:
  - (1) List of Subcontractors
  - (2) Equal Employment Opportunity Certification
  - (3) Public Contract Code
    - Section 10285.1 Statement
    - Section 10162 Questionnaire
    - Section 10232 Statement
  - (4) Noncollusion Declaration
  - (5) Debarment and Suspension Certification
  - (6) Statement Concerning Employment of Undocumented Aliens
  - (7) Contractor's Certificate as to Worker's Compensation
  - (8) Waiver for Payment Adjustments for Price Index Fluctuations
  - (9) Contractor's Certification of Good Faith Effort to Employ Monterey Bay Area Residents
  - (10) List of Satisfied Public Agencies
  - (11) Bidder's Bond
7. If this bid is accepted by the Owner, then the undersigned shall, within ten (10) business days after receipt of the Letter of Intent to Award, execute and deliver to the Owner (a) a contract in the form set forth in the contract documents on which this bid is based, (b) a payment bond for public works, as required by the contract documents, (c) a performance bond, as similarly required, and (d) insurance certificates showing all required insurance coverage. The undersigned will thereafter commence and complete the work within the time required by the contract documents.

In the event the bidder to whom the Letter of Intent to Award Contract is given fails or refuses to contract as required, including to post the required bonds, provide the

insurance certificates, and return the executed copies of the agreement form within ten (10) business days from the date of receiving the Letter of Intent to Award Contract, the County may, at its option, determine that the bidder has abandoned the contract, reject the bid, and declare the bidder's security forfeited as damages and same shall become the property of the County of Monterey.

8. Notice of acceptance and any requests for additional information should be addressed to the undersigned at the following address:

---

---

---

9. The names of all persons interested in the foregoing proposal as principals are as follows:

---

---

---

(IMPORTANT NOTICE: If the bidder or other interested person is a corporation, state the legal name of the corporation, and the names of the president, secretary, treasurer, and manager thereof; if a partnership, state the name of the firm and the names of all the individual partners composing the firm; if the bidder or other interested person is an individual, state the first and last names in full and give all fictitious names under which the individual does business.)

10. By execution of this bid, the undersigned bidder declares that he/she/it is a contractor licensed in accordance with the Contractors' State License Law, as follows:

Classification: \_\_\_\_\_  
License number: \_\_\_\_\_  
Expiration date: \_\_\_\_\_

11. ADDENDA - This Bid is submitted with respect to the changes to the contract included in addenda number(s) \_\_\_\_, \_\_\_\_, \_\_\_\_, \_\_\_\_, \_\_\_\_, \_\_\_\_, \_\_\_\_, and \_\_\_\_. If the Bidder submits this bid without all issued addenda, the agency finds your bid nonresponsive.

(Fill in addenda numbers if addenda have been received and insert, in this Bid, any Engineer's Estimate sheets that were received as part of the addenda. By signing this Bid on the signature portion thereof, the Bidder acknowledges receipt of all addenda.)

12. This bid is submitted pursuant to Section 7103.5(b) of the California Public Contract Code which states,

(a) As used in this section:

(1) "Public works contract" means a contract awarded through competitive bids by the state or any of its political subdivisions or public agencies, on whose behalf the Attorney General may bring an action pursuant to subdivision (c) of Section 16750 of the Business and Professions Code, for the erection, construction,

alteration, repair, or improvement of any structure, building, road, or other improvement of any kind.

(2) "Awarding body" means the state or the subdivision or agency awarding a public works contract.

(b) In entering into a public works contract or a subcontract to supply goods, services, or materials pursuant to a public works contract, the contractor or subcontractor offers and agrees to assign to the awarding body all rights, title, and interest in and to all causes of action it may have under Section 4 of the Clayton Act (15 U.S.C. Sec. 15) or under the Cartwright Act (Chapter 2 (commencing with Section 16700) of Part 2 of Division 7 of the Business and Professions Code), arising from purchases of goods, services, or materials pursuant to the public works contract or the subcontract. This assignment shall be made and become effective at the time the awarding body tenders final payment to the contractor, without further acknowledgment by the parties.

(c) Subdivision (b) shall be included in full in the specifications for the public works contract or in the general provisions incorporated therein and shall be included in full in the public works contract or in the general provisions incorporated therein.

By submitting this bid to the County, the bidder offers and agrees that if the bid is accepted, and a contract is awarded, it will assign to the County all rights, title, and interest in and to all causes of action it may have under Section 4 of the Clayton Act (15 USC Section 15) or under the Cartwright Act (Chapter 2 [commencing with Section 16700] of Part 2 of Division 7 of the California Business and Professions Code), arising from purchases of goods, services, or materials by the bidder/contractor/subcontractor pursuant to the public works contract or subcontract. Such assignment shall be made and become effective at the time the awarding body tenders final payment to the bidder/contractor, without further acknowledgment by the parties.



By my signature on this bid I certify, under penalty of perjury under the laws of the State of California, the foregoing questionnaire and statements of Public Contract Code Sections 10162, 10232 and 10285.1 are true and correct and the bidder has complied with the requirements of Section 8103 of the Fair Employment and Housing Commission Regulations (Chapter 5, Title 2 of the California Administrative Code). By my signature on this Bid I further certify, under penalty of perjury under the laws of the State of California and the United States of America, the Equal Employment Opportunity Certification; the Title 49 Code of Federal Regulations, Part 29 Debarment and Suspension Certification; the Statement Concerning Employment of Undocumented Aliens; and the Contractor's Certification as to Workers' Compensation are true and correct.

Dated: \_\_\_\_\_

\_\_\_\_\_  
Bidder's Business Name

By: \_\_\_\_\_

Print Name: \_\_\_\_\_

Title: \_\_\_\_\_

By: \_\_\_\_\_

Print Name: \_\_\_\_\_

Title: \_\_\_\_\_

(NOTE: If bidder is a corporation, the full legal name of the corporation shall be set forth above together with the names, titles and signatures of two (2) officers pursuant to California Corporations Code Section 313 and the document shall bear the corporate seal; if bidder is a Limited Liability Corporation (LLC), the full legal name of the LLC shall be set forth above together with the names and signatures of two (2) managers pursuant to Corporations Code Section 17703.01; if bidder is a partnership, the full name of the firm shall be set forth above together with the signature of the partner or partners authorized to sign Contracts on behalf of the partnership; and if bidder is an individual, his/her name and signature shall be placed above.)

**LIST OF SUBCONTRACTORS**

In compliance with the Subletting and Subcontracting Fair Practices Act (Chapter 4 [commencing with Section 4100], Part 1, Division 2 of the Public Contract Code) and any amendments thereto, each bidder shall set forth below: (a) the name and the location of the place of business of each subcontractor who will perform work or labor or render service to the prime contractor in or about the construction of the work or improvement to be performed under this contract or a subcontractor licensed by the State of California who, under subcontract to the prime contractor, specially fabricates and installs a portion of the work or improvement according to detailed drawings contained in the plans and specifications in an amount in excess of one-half of one percent of the prime contractor's total bid or, in the case of bids or offers for the construction of streets or highways, including bridges, in excess of one-half of one percent of the prime contractor's total bid or \$10,000, whichever is greater, and (b) the portion of the work which will be done by each subcontractor under this Act. The prime contractor shall list only one subcontractor for each such portion as is defined by the prime contractor in this bid.

If a prime contractor fails to specify a subcontractor or if a prime contractor specifies more than one subcontractor for the same portion of the work to be performed under the contract in excess of one-half of one percent of the prime contractor's total bid, he/she/it shall be deemed to have agreed that he/she/it is fully qualified to perform that portion himself/herself/itself, and that he/she/it shall perform that portion himself/herself/itself.

No prime contractor whose bid is accepted shall: (a) substitute any subcontractor, (b) permit any subcontract to be voluntarily assigned or transferred or allow it to be performed by anyone other than the original subcontractor listed in the original bid, or (c) sublet or subcontract any portion of the work in excess of one-half of one percent of the prime contractor's total bid as to which his/her/its original bid did not designate a subcontractor, except as authorized in the Subletting and Subcontracting Fair Practices Act. Subletting or subcontracting of any portion of the work in excess of one-half of one percent of the prime contractor's total bid as to which no subcontractor was designated in the original bid shall only be permitted in cases of public emergency or necessity, and then only after a finding reduced to writing as a public record of the authority awarding this contract setting forth the facts constituting the emergency or necessity.

- Check this box if no subcontractors are required to be listed for work or labor to be performed or services to be rendered.

\_\_\_\_\_  
Bidder's business name

By: \_\_\_\_\_

Print Name: \_\_\_\_\_

Title: \_\_\_\_\_

**BIDDER'S LIST OF SUBCONTRACTORS (DBE and NON-DBE)- PART I**

The bidder shall list all subcontractors (both DBE and non-DBE) in accordance with Section 2-1.054 of the Standard Specifications and per Title 49, Section 26.11 of the Code of Federal Regulations. This listing is required in addition to listing DBE Subcontractors elsewhere in the proposal. **Photocopy this form for additional firms.**

Firm Name/ Address/ City, State, ZIP	License #/ Phone/ Fax	Annual Gross Receipts	Description of Portion of Work to be Performed	Certified DBE?
<i>Name</i>	<i>Lic.#</i>	<input type="checkbox"/> < \$1 million <input type="checkbox"/> < \$5 million		<input type="checkbox"/> YES <input type="checkbox"/> NO <i>If YES list DBE #:</i>
<i>Address</i>	<i>Phone</i>	<input type="checkbox"/> < \$10 million <input type="checkbox"/> < \$15 million		<i>Age of Firm (Yrs.)</i>
<i>City State ZIP</i>	<i>Fax</i>	<input type="checkbox"/> > \$15 million		
<i>Name</i>	<i>Lic.#</i>	<input type="checkbox"/> < \$1 million <input type="checkbox"/> < \$5 million		<input type="checkbox"/> YES <input type="checkbox"/> NO <i>If YES list DBE #:</i>
<i>Address</i>	<i>Phone</i>	<input type="checkbox"/> < \$10 million <input type="checkbox"/> < \$15 million		<i>Age of Firm (Yrs.)</i>
<i>City State ZIP</i>	<i>Fax</i>	<input type="checkbox"/> > \$15 million		
<i>Name</i>	<i>Lic.#</i>	<input type="checkbox"/> < \$1 million <input type="checkbox"/> < \$5 million		<input type="checkbox"/> YES <input type="checkbox"/> NO <i>If YES list DBE #:</i>
<i>Address</i>	<i>Phone</i>	<input type="checkbox"/> < \$10 million <input type="checkbox"/> < \$15 million		<i>Age of Firm (Yrs.)</i>
<i>City State ZIP</i>	<i>Fax</i>	<input type="checkbox"/> > \$15 million		
<i>Name</i>	<i>Lic.#</i>	<input type="checkbox"/> < \$1 million <input type="checkbox"/> < \$5 million		<input type="checkbox"/> YES <input type="checkbox"/> NO <i>If YES list DBE #:</i>
<i>Address</i>	<i>Phone</i>	<input type="checkbox"/> < \$10 million <input type="checkbox"/> < \$15 million		<i>Age of Firm (Yrs.)</i>
<i>City State ZIP</i>	<i>Fax</i>	<input type="checkbox"/> > \$15 million		

**Distribution:** 1) Original - Local Agency File

**BIDDER'S LIST OF SUBCONTRACTORS (DBE and NON-DBE)- PART II**

The bidder shall list all subcontractors who provided a quote or bid but were not selected to participate as a subcontractor on this project. This is required for compliance with Title 49, Section 26 of the Code of Federal Regulations. **If this form is not submitted with the bid, it must be received by the Agency no later than 4:00 p.m. on the 4<sup>th</sup> business day after bid opening. Photocopy this form for additional firms.**

Firm Name/ Address/ City, State, ZIP	License #/ Phone/ Fax	Annual Gross Receipts	Description of Portion of Work to be Performed	Certified DBE?
<i>Name</i>	<i>Lic.#</i>	<input type="checkbox"/> < \$1 million <input type="checkbox"/> < \$5 million		<input type="checkbox"/> YES <input type="checkbox"/> NO
<i>Address</i>	<i>Phone</i>	<input type="checkbox"/> < \$10 million <input type="checkbox"/> < \$15 million		<i>If YES list DBE #:</i>
<i>City State ZIP</i>	<i>Fax</i>	<input type="checkbox"/> > \$15 million		Age of Firm (Yrs.)
<i>Name</i>	<i>Lic.#</i>	<input type="checkbox"/> < \$1 million <input type="checkbox"/> < \$5 million		<input type="checkbox"/> YES <input type="checkbox"/> NO
<i>Address</i>	<i>Phone</i>	<input type="checkbox"/> < \$10 million <input type="checkbox"/> < \$15 million		<i>If YES list DBE #:</i>
<i>City State ZIP</i>	<i>Fax</i>	<input type="checkbox"/> > \$15 million		Age of Firm (Yrs.)
<i>Name</i>	<i>Lic.#</i>	<input type="checkbox"/> < \$1 million <input type="checkbox"/> < \$5 million		<input type="checkbox"/> YES <input type="checkbox"/> NO
<i>Address</i>	<i>Phone</i>	<input type="checkbox"/> < \$10 million <input type="checkbox"/> < \$15 million		<i>If YES list DBE #:</i>
<i>City State ZIP</i>	<i>Fax</i>	<input type="checkbox"/> > \$15 million		Age of Firm (Yrs.)
<i>Name</i>	<i>Lic.#</i>	<input type="checkbox"/> < \$1 million <input type="checkbox"/> < \$5 million		<input type="checkbox"/> YES <input type="checkbox"/> NO
<i>Address</i>	<i>Phone</i>	<input type="checkbox"/> < \$10 million <input type="checkbox"/> < \$15 million		<i>If YES list DBE #:</i>
<i>City State ZIP</i>	<i>Fax</i>	<input type="checkbox"/> > \$15 million		Age of Firm (Yrs.)

**Distribution:** 1) Original - Local Agency File

**EQUAL EMPLOYMENT OPPORTUNITY CERTIFICATION**

The bidder \_\_\_\_\_,  
proposed subcontractor \_\_\_\_\_,  
hereby certifies that he/she/it has \_\_\_\_, has not \_\_\_\_, participated in a previous contract or subcontract subject to the equal opportunity clauses, as required by Executive Orders 10925, 11114, or 11246, and that, where required, he/she/it has filed with the Joint Reporting committee, the Director of the Office of Federal Contract Compliance, a Federal Government contracting or administering agency, or the former President’s Committee on Equal Employment Opportunity, all reports due under the applicable filing requirements.

Note: The above Certification is part of the Bid. Signing this Bid on the signature portion thereof shall also constitute signature of this Certification. Providing false information may result in criminal prosecution or administrative sanctions.

**PUBLIC CONTRACT CODE**

**PUBLIC CONTRACT CODE SECTION 10285.1 STATEMENT**

In accordance with Public Contract Code Section 10285.1 (Chapter 376, Stats. 1985), the bidder hereby declares under penalty of perjury under the laws of the State of California that the bidder and any and all subcontractor(s) to be engaged by the bidder has/have \_\_\_\_\_, has/have not \_\_\_\_\_ been convicted within the preceding three years of any offenses referred to in that section, including any charge of fraud, bribery, collusion, conspiracy, or any other act in violation of any state or Federal antitrust law in connection with the bidding upon, award of, or performance of, any public works and facilities Contract, as defined in Public Contract Code Section 1101, with any public entity, as defined in Public Contract Code Section 1100, including the Regents of the University of California or the Trustees of the California State University. The term "bidder" is understood to include any partner, member, officer, director, responsible managing officer, or responsible managing employee thereof, as referred to in Section 10285.1.

Note: The bidder must place a check mark after "has" or "has not" in one of the blank spaces provided.

---

**PUBLIC CONTRACT CODE SECTION 10162 QUESTIONNAIRE**

In accordance with Public Contract Code Section 10162, the Bidder shall complete, under penalty of perjury, the following questionnaire:

Has the bidder, any officer of the bidder, or any employee of the bidder who has a proprietary interest in the bidder, ever been disqualified, removed, or otherwise prevented from bidding on, or completing a federal, state, or local government project because of a violation of law or a safety regulation?

Yes \_\_\_\_\_ No \_\_\_\_\_

If the answer is yes, explain the circumstances in the following space.

## **PUBLIC CONTRACT CODE SECTION 10232 STATEMENT**

In accordance with Public Contract Code Section 10232, the Contractor, hereby states under penalty of perjury, that no more than one (1) final unappealable finding of contempt of court by a federal court has been issued against the Contractor within the immediately preceding two (2) year period because of the Contractor's failure to comply with an order of a federal court which orders the Contractor to comply with an order of the National Labor Relations Board.

Note: The above Public Contract Code Statements and Questionnaire are part of the Bid. Signing this Bid on the signature portion thereof shall also constitute signature of these Statements and Questionnaire. Bidders are cautioned that making a false certification may subject the certifier to criminal prosecution.

**NONCOLLUSION DECLARATION**  
**TO BE EXECUTED BY BIDDER AND SUBMITTED WITH BID**  
(Public Contract Code Section 7106)

The undersigned declares:

I am the \_\_\_\_\_ of \_\_\_\_\_, the party making the foregoing bid.

The bid is not made in the interest of, or on behalf of, any undisclosed person, partnership, company, association, organization, or corporation. The bid is genuine and not collusive or sham. The bidder has not directly or indirectly induced or solicited any other bidder to put in a false or sham bid. The bidder has not directly or indirectly colluded, conspired, connived, or agreed with any bidder or anyone else to put in a sham bid, or to refrain from bidding. The bidder has not in any manner, directly or indirectly, sought by agreement, communication, or conference with anyone to fix the bid price of the bidder or any other bidder, or to fix any overhead, profit, or cost element of the bid price, or of that of any other bidder. All statements contained in the bid are true. The bidder has not, directly or indirectly, submitted his or her bid price or any breakdown thereof, or the contents thereof, or divulged information or data relative thereto, to any corporation, partnership, company, association, organization, bid depository, or to any member or agent thereof, to effectuate a collusive or sham bid, and has not paid, and will not pay, any person or entity for such purpose.

Any person executing this declaration on behalf of a bidder that is a corporation, partnership, joint venture, limited liability company, limited liability partnership, or any other entity, hereby represents that he or she has full power to execute, and does execute, this declaration on behalf of the bidder.

I declare under penalty of perjury under the laws of the State of California that the foregoing is true and correct and that this declaration is executed on \_\_\_\_\_ [date], at \_\_\_\_\_ [city], \_\_\_\_\_ [state].

Signature: \_\_\_\_\_

Print Name: \_\_\_\_\_



## **DEBARMENT AND SUSPENSION CERTIFICATION**

Title 2, Code of Federal Regulations, Part 180

The bidder, under penalty of perjury, certifies that, except as noted below, he/she or any person associated therewith in the capacity of owner, partner, director, officer, manager:

- is not currently under suspension, debarment, voluntary exclusion, or determination of ineligibility by any federal agency;
- has not been suspended, debarred, voluntarily excluded or determined ineligible by any federal agency within the past three (3) years;
- does not have a proposed debarment pending; and,
- has not been indicted, convicted, or had a civil judgment rendered against it by a court of competent jurisdiction in any matter involving fraud or official misconduct within the past three (3) years.

If there are any exceptions to this certification, insert the exceptions in the following space.

Exceptions will not necessarily result in denial of award, but will be considered in determining bidder responsibility. For any exception noted above, indicate below to whom it applies, initiating agency, and dates of action.

Note: The above Certification is part of the Bid. Signing this Bid on the signature portion thereof shall also constitute signature of this Certification. Providing false information may result in criminal prosecution or administrative sanctions.

**STATEMENT CONCERNING EMPLOYMENT OF UNDOCUMENTED ALIENS**

(Public Contract Code Section 6101)

California Public Contract Code section 6101 provides that,

A state agency, as defined in Section 10335.7, that is subject to this code, shall not award a public works or purchase contract to a bidder or contractor, nor shall a bidder or contractor be eligible to bid for or receive a public works or purchase contract, who has, in the preceding five years, been convicted of violating a state or federal law respecting the employment of undocumented aliens.

In conformance with Public Contract Code Section 6101, the bidder certifies compliance with state and federal law with respect to the employment of undocumented aliens by signing this proposal on the signature portion thereof.

Note: The above Statement is part of the Bid. Signing this Bid on the signature portion thereof shall also constitute signature of this Statement. Providing false information may result in rescission of any contract awarded to bidder, criminal prosecution and/or administrative sanctions.

**CONTRACTOR'S CERTIFICATE AS TO WORKER'S COMPENSATION**

(Labor Code Section 1861)

Labor Code Section 3700 provides, in relevant part:

"Every employer except the State shall secure the payment of compensation in one (1) or more of the following ways:

- "(a) By being insured against liability to pay compensation in one or more insurers duly authorized to write compensation insurance in this State.
- "(b) By securing from the Director of Industrial Relations a certificate of consent to self-insure either as an individual employer, or as one (1) employer in a group of employers, which may be given upon furnishing proof satisfactory to the Director of Industrial Relations of ability to self-insure and to pay any compensation that may become due to his or her employees."

I certify that I am aware of the provisions of Section 3700 of the Labor Code which require every employer to be insured against liability for Workers' Compensation or to undertake self-insurance in accordance with the provisions of that Code, and I will comply with such provisions before commencing the performance of the work of this contract.

Note: The above Certification is part of the Bid. Signing this Bid on the signature portion thereof shall also constitute signature of this Certification. Providing false information may result in criminal prosecution or administrative sanctions.

**WAIVER FOR PAYMENT ADJUSTMENT FOR PRICE INDEX FLUCTUATIONS**

The bidder may opt to waive the provisions of Section 9-1.07, "Payment Adjustments for Price Index Fluctuations" of the Standard Specifications.

Checking "YES" and signing this form shall constitute that the Contractor's bids are not subject to the provisions of Section 9-1.07, "Payment Adjustments for Price Index Fluctuations" of the Standard Specifications.

Checking "NO" and signing this form shall constitute that the Contractor's bids shall be adjusted in accordance to the provisions of Section 9-1.07, "Payment Adjustments for Price Index Fluctuations" of the Standard Specifications.

Yes \_\_\_\_\_ No \_\_\_\_\_

Bidder's Business Name: \_\_\_\_\_

Signature: \_\_\_\_\_

Print Name and Title: \_\_\_\_\_

**CONTRACTOR'S CERTIFICATION OF GOOD-FAITH EFFORT TO EMPLOY**  
**MONTEREY BAY AREA RESIDENTS**  
(Monterey County Code Section 5.08.120)

I CERTIFY THAT I am aware of the provision of Monterey County Code Section 5.08.120. Monterey County Code Section 5.08.120 provides, in relevant part:

A. General Provisions. All County contracts for public works of improvement shall contain provisions pursuant to which the contractor shall make a good-faith effort to employ qualified individuals who are, and have been for at least one (1) year out of the past three (3) years prior to the opening of bids, residents of the Monterey Bay Area in sufficient numbers so that no less than fifty percent (50%) of the contractors total construction work force, on that particular contract, including any subcontractor work force (with exception of specialty subcontractor items identified in bid items) measured in labor work hours, is comprised of Monterey Bay Area residents.

B. Non-responsive Bidder Declaration: Enforcement. If any contractor submitting a bid for a contract for public works of improvement fails to abide by the good-faith local employment provisions of this Section, the contractor may be declared by the Board to be a non-responsive bidder for purposes of this Chapter. If a contractor lists in his or her bid a subcontractor who is currently disqualified under the terms of this Section, the Board may declare said contractor to be a non-responsive bidder for purposes of this Chapter. If the Board finds that a contractor to whom a contract for public works of improvement has been awarded has failed to comply with the good-faith employment provisions of this Section during the performance of the contract, the Board may disqualify the contractor from bidding on any County contract for public works of improvement for a period of one (1) year from the date of the Board's disqualification. A subsequent violation of this Section by a contractor may result in disqualification by the Board for a period of three (3) years from the date of the subsequent disqualification.

C. Binding on Subcontractors. Every contractor entering into a contract for public works of improvement subject to the provisions of this Section shall include in each and every subcontract for work, laborers, or materialmen relating to the project the requirement that the subcontractor shall make a good-faith effort to employ qualified individuals who are, and have been for at least one (1) year out of the past three (3) years prior to the opening of bids, residents of the Monterey Bay Area. If the Board finds that any subcontractor has failed during the performance of the subcontract to comply with this Section, the Board may disqualify said subcontractor from submitting or being listed in any bid for any County contract for public works of improvement for a period of one (1) year from the date of the Board's disqualification. A subsequent violation by a subcontractor may result in disqualification by the Board for a period of three (3) years from the date of the subsequent disqualification."

I FURTHER CERTIFY AS FOLLOWS (check the box that applies):

I CERTIFY that at least fifty percent (50%) of the total construction work force on the project, including any subcontractor work force, measured in labor work hours, will be comprised of qualified individuals who to the best of my knowledge are, and have been for at least one (1) year out of the past three (3) years prior to the effective date of the opening of bids, residents of the Monterey Bay Area. Evidence that I will comply with this requirement is as follows (please use additional pages to provide supporting evidence and/or documentation, as necessary):

---

---

---

---

I CERTIFY that I shall make a good-faith effort to employ qualified individuals who, to the best of my knowledge, are, and have been for at least one (1) year out of the past three (3) years prior to the effective date of the opening of bids, residents of the Monterey Bay Area in sufficient numbers such that no less than fifty percent (50%) of the total construction work force on the project, including any subcontractor work force (with the exception of specialty subcontractor items identified in the bid items) measured in labor work hours, will be comprised of Monterey Bay Area residents. Attached is my written plan to recruit Monterey Bay residents as part of the construction workforce.

I CERTIFY that I do not comply with and am unable to make a good-faith effort to comply with the good-faith local employment provisions set forth in Monterey County Code Section 5.08.120. Explanation to why I am not able to comply is as follows (please use additional pages to provide supporting evidence and/or documentation, as necessary):

---

---

---

---

I declare under penalty of perjury under the laws of the State of California that the foregoing certification is true and correct. Executed on (date) \_\_\_\_\_ at (city/state) \_\_\_\_\_.

Bidder's Business Name: \_\_\_\_\_

Signature: \_\_\_\_\_

Print Name and Title: \_\_\_\_\_

**LIST OF SATISFIED PUBLIC AGENCIES**

(Two minimum)

<b>Agency Name</b>	<b>Project Name</b>	<b>Contact Person</b>	<b>Award Date</b>	<b>Phone No.</b>
--------------------	---------------------	-----------------------	-------------------	------------------

**BIDDER'S BOND**

WHEREAS, the Principal named below has submitted the accompanying bid to the County of Monterey, a political subdivision of the State of California (hereinafter called "County"), for the following project:

\_\_\_\_\_  
(exact description as on bid); and

WHEREAS, Principal as bidder, is required to furnish a bond executed by an admitted surety in connection with said bid, to secure timely execution of the contract and delivery of the bonds and insurance certificates, in the event that the contract is awarded to Principal; and

WHEREAS, the Principal has submitted the above- mentioned bid to the County, for which bids are to be opened at \_\_\_\_\_(city where bid opening), California, on, \_\_\_\_\_(date bid opening).

NOW, THEREFORE, we \_\_\_\_\_  
\_\_\_\_\_, PRINCIPAL, and \_\_\_\_\_  
\_\_\_\_\_ as SURETY, are held and firmly bound unto the County in the penal sum of \_\_\_\_\_ Dollars (\$ \_\_\_\_\_) which sum is not less than ten percent (10%) of the total amount of the base bid amount including all alternates submitted by said above-named Principal to the County, for the project described below, for the payment of which sum in lawful money of the United States, well and truly to be made to the County, we bind ourselves, our heirs, executors, administrators and successors, jointly and severally, firmly by these presents.

THE CONDITION OF THIS OBLIGATION IS SUCH, That

If the aforesaid Principal is awarded the contract and, within the time and manner required under the specifications, after the prescribed forms are presented to him for signature, enters into a written contract, in the prescribed form, in accordance with the bid, and files two bonds with the County of Monterey, one to guarantee faithful performance and the other to guarantee payment for labor and materials, as required by law and said contract documents, then this obligation shall be null and void; otherwise, it shall be and remain in full force and virtue.

Surety hereby stipulates and agrees that no change, extension of time, alteration or addition to the terms of the contract on the call for bids, or to the work to be performed thereunder, or the specifications accompanying the same, shall in any way affect its obligation under this bond, and it does hereby waive notice of any such change, extension of time, alteration or addition to the terms of said contract or the call for bids, or to the work or to the specifications.

If the County brings suit upon this bond and judgment is recovered, the Surety shall pay all litigation expenses incurred by the County in such suit, including attorney's fees, court costs, expert witness fees and investigation expenses.



IN WITNESS WHEREOF the above-bound parties have executed this instrument under their several seals this \_\_\_\_\_ day of \_\_\_\_\_, 20\_\_\_\_, the name and corporate seal of each corporate party being hereto affixed and these presents duly signed by its undersigned representative, pursuant to authority of its governing body.

(Corporate Seal)

\_\_\_\_\_  
Principal  
By \_\_\_\_\_  
Name and Title \_\_\_\_\_

(Corporate Seal)

\_\_\_\_\_  
Surety  
By \_\_\_\_\_  
Name and Title \_\_\_\_\_

(Attach notary acknowledgement for all signatures and original or certified copy of unresolved appointment, attorney-in-fact certificate, power of attorney, by laws, or other instrument entitling or authorizing person executing bond on behalf of Surety to do so.)

This page intentionally left blank.