



COUNTY OF MONTEREY
DEPARTMENT OF PUBLIC WORKS, FACILITIES, & PARKS

1441 Schilling Place, South 2nd Floor
SALINAS, CA 93901-4527

(831) 755-4800

REQUEST FOR PROPOSALS #10807

TO PROVIDE
CONSTRUCTION MANAGEMENT SERVICES
FOR ROBINSON CANYON ROAD BRIDGE SCOUR REPAIR PROJECT
LOCATED IN MONTEREY COUNTY, CALIFORNIA

Proposals Due: **3:00 p.m. PST, Friday April 22, 2022**

APPROVED AS TO FORM
OFFICE OF THE COUNTY COUNSEL
LESLIE J. GIRARD, COUNTY COUNSEL

DocuSigned by:

Mary Grace Perry

A1933B20E717442...

MARY GRACE PERRY
DEPUTY COUNTY COUNSEL

Date: 3/15/2022 | 5:31 PM PDT

Table of Contents

1.0 INTENT..... 3

2.0 LICENSING/SECURITY REQUIREMENTS 3

3.0 BACKGROUND 3

4.0 CALENDAR OF EVENTS 4

5.0 COUNTY POINT OF CONTACT..... 5

6.0 SCOPE OF WORK 5

7.0 REQUIRED CONTENT/FORMAT FOR PROPOSAL PACKAGE 8

8.0 SUBMITTAL INSTRUCTIONS & CONDITIONS 11

9.0 SELECTION CRITERIA 12

10.0 AGREEMENT AWARD 14

11.0 SEQUENTIAL AGREEMENT NEGOTIATION 14

12.0 AGREEMENT TERMS AND CONDITIONS..... 14

13.0 COLLUSION..... 15

14.0 RIGHTS TO PERTINENT MATERIALS..... 15

15.0 INDEMNIFICATION 15

16.0 INSURANCE REQUIREMENTS 16

APPENDIX I: SIGNATURE PAGE

APPENDIX II: SAMPLE AGREEMENT

APPENDIX III: EXHIBIT B FEDERAL PROVISIONS

APPENDIX IV: EXHIBIT 10-H2 COST PROPOSAL

APPENDIX V: PROJECT PLANS AND SPECIFICATIONS

1.0 INTENT

- 1.1 The County of Monterey Department of Public Works, Facilities, & Parks (PWFP), hereinafter referred to as “County”, is soliciting proposals from qualified firms, hereinafter referred to as “CONTRACTOR”, to provide construction management services for the Robinson Canyon Road Bridge Scour Repair Project, hereinafter referred to as “Project” located in Carmel Valley, Monterey County, California. Interested CONTRACTOR(s) are to submit their proposals per this Request for Proposals (RFP) #10807.
- 1.2 The scope of work, in general, shall include professional engineering services required for management of a construction contract in the public sector. The services provided shall include engineering inspection services, environmental support services, materials testing, and surveying services necessary to verify the Project is constructed as specified in the Project plans and specifications.
- 1.3 This solicitation is intended to create a single, exclusive service AGREEMENT.

Note: Regulatory Permits for the project are in progress and will be forthcoming.

2.0 LICENSING/SECURITY REQUIREMENTS

- 2.1 Interested CONTRACTORS must meet ALL of the following qualification requirements in order to be considered by County:
- 2.1.1 CONTRACTOR shall have the necessary licenses, certifications, and knowledge to adequately complete the tasks outlined in Section 6.0, Scope of Work.
 - 2.1.2 CONTRACTOR shall have a minimum of five (5) years of experience managing and controlling the construction of bridge, roadway, and drainage related projects. Experience shall be in the State of California.
 - 2.1.3 CONTRACTOR’s project manager shall have a minimum of five (5) years specializing in bridge and road construction in the State of California, and thorough understanding of Caltrans Standard Plans and Specifications, Caltrans Local Assistance Procedures Manual (LAPM), Caltrans Local Assistance Program Guidelines (LAPG), Caltrans Construction Manual, Caltrans Highway Bridge Program (HBP) and Federal Highway Administration (FHWA) Highway Bridge Replacement & Rehabilitation Program (HBRRP).
 - 2.1.4 The CONTRACTOR’s Resident Engineer (RE) assigned to the Project is required to be a California licensed Civil Engineer.

3.0 BACKGROUND

- 3.1 The County is located on the Central Coast of California, approximately 120 miles south of San Francisco. The County is approximately 3,350 square miles.
- 3.2 The County has a need for construction management services for the Robinson Canyon Road Bridge Scour Repair Project. The Project scope is comprised of constructing scour

countermeasures for the bridge to protect both piers with ½-ton rock slope protection and installing articulated concrete block (ACB) mats near and around one (1) of the bridge abutments.

- 3.3 The existing Robinson Canyon Road Bridge (Bridge No. 44C0017), hereinafter referred to as “bridge” was built in 1971. It is a three (3)-span continuous reinforced concrete box girder on reinforced concrete pier walls and diaphragm abutments. According to a Caltrans Bridge Inspection Report (2012), this structure was evaluated for scour in 2005 and is considered to be scour critical. The County plans to perform improvements around the bridge piers and abutments to prevent erosion and scour from water flowing in the Carmel River. The Project site is located 0.1 mile south of Carmel Valley Road.

The proposed Project would entail the placement of rock riprap and root wad as a scour repair. Work at Abutment 1, Pier 2 and Pier 3 is not expected to involve any modification to the concrete pile cap or abutment piles. Work is expected to involve the placement of rock slope protection in these areas. No modification is expected for the north abutment. As is standard with all roadway projects, CONTRACTOR will be required to install temporary Best Management Practices (BMPs) to control any runoff or erosion from the Project site into the surrounding waterways. These temporary BMPs will be installed prior to the initiation of construction operations and will be in place for the duration of the contract. The removal of these BMPs will be the final operation, along with Project site cleanup.

All equipment and materials will be stored at a temporary staging area located within the Project limits. Two (2) staging areas are proposed: one (1) southwest and one (1) southeast of the existing bridge. Construction access to the staging areas would be directly from the existing roadway; however, temporary access to the river will be needed to access the scour repair location.

- 3.4 The federal lead agency for the project is the Federal Highway Administration with oversight from the California Department of Transportation (Caltrans) District 5 Division of Local Assistance. The project shall fully comply with Chapter 6 of the Local Assistance Programs Guidelines (LAPG) and the entire Local Assistance Procedures Manual (LAPM)

4.0 CALENDAR OF EVENTS

4.1	Release RFP	Thursday, March 17, 2022
4.2	Deadline for Written Questions	3:00 p.m., PST, Friday, April 1, 2022
4.3	Posted Response to Written Questions	5:00 p.m., PST, Thursday, April 7, 2022
4.4	Proposal Package Submittal Deadline	3:00 p.m., PST, Friday, April 22, 2022
4.5	Estimated Notification of Selection	May 12, 2022
4.6	Estimated AGREEMENT Date	June 2022
4.7	Estimated Start of Construction	Summer 2022

4.7 FUTURE ADDENDA: CONTRACTORS who received notification of this solicitation by means other than through a County mailing, shall contact the person designated in the COUNTY POINT OF CONTACT herein to request to be added to the mailing list. Inclusion on the mailing list is the only way to ensure timely notification of any addenda and/or information that may be issued prior to the solicitation submittal date. **IT IS THE CONTRACTORS' SOLE RESPONSIBILITY TO ENSURE THAT THEY RECEIVE ANY AND ALL ADDENDA FOR THIS RFP** by either informing County of their mailing information or by regularly checking the PWWP Projects Out to Bid webpage at <https://www.co.monterey.ca.us/government/departments-i-z/public-works-facilities-parks/public-works/projects-out-to-bid>. Addenda are posted on the website the day they are released.

5.0 COUNTY POINT OF CONTACT

5.1 Questions and correspondence regarding this solicitation shall be directed to:

Enrique Saavedra, PE
County of Monterey Department of Public Works, Facilities, & Parks
1441 Schilling Place, South 2nd Floor
Salinas, California 93901-4527
Phone: (831) 755-8970

Email: saavedraem@co.monterey.ca.us

All questions regarding this solicitation shall be submitted in writing (E-mail acceptable and preferable). When submitting questions, please identify the RFP # to which the question pertains. Questions will be researched, and answers will be posted on the PWWP Projects Out to Bid webpage at <https://www.co.monterey.ca.us/government/departments-i-z/public-works-facilities-parks/public-works/projects-out-to-bid> by the deadline indicated in the **CALENDAR OF EVENTS** herein.

5.2 The deadline for submitting written questions regarding this solicitation is indicated in the **CALENDAR OF EVENTS** herein. Questions submitted after the deadline will not be answered.

5.3 Only answers to questions communicated by formal written addenda will be binding.

5.4 Prospective CONTRACTOR shall not contact County officers or employees with questions or suggestions regarding this solicitation except through the designated contact listed above or designated project manager. **Any unauthorized contact may be considered undue pressure and cause for disqualification of the CONTRACTOR.**

6.0 SCOPE OF WORK

6.1 Contractor Minimum Work Performance Percentage: CONTRACTOR shall perform with its own organization AGREEMENT work amounting to not less than fifty percent (50%) of the original total AGREEMENT price.

6.2 The County plans to perform improvements around the bridge piers and abutments to prevent erosion and scour from water flowing in the Carmel River. The Project scope comprises of

constructing scour countermeasures for the bridge to protect both piers with ½-ton rock slope protection and installing ACB mats near and around one (1) of the bridge abutments.

6.3 The broad construction management scope of this Project requires a diversity of expertise and the ability to respond and or resolve a number of specialized construction contract issues. Of particular concern are the qualifications and experience of the individual(s) who will be directly involved in the Project, as they relate to Caltrans.

6.4 The construction management effort shall include, but not be limited to, the following services and requirements:

Contract Administration: Provide overall coordination of construction management services, including supervision of contract administration, labor compliance, Disadvantaged Business Enterprises (DBE) programs, field observations and outside services. Attend regularly scheduled project meetings with the County or CONTRACTOR representatives to review the progress of the work, resolve field problems as they occur, and perform project related public relations with the public and outside agencies such as the United States Army Corps of Engineers (USACE), the California Department of Fish and Wildlife (CDFW), the Regional Water Quality Control Board (RWQCB), and Monterey Peninsula Water Management District.

General Inspection: Provide daily inspections and supervision of the work of the construction contractor's operations as construction progresses, and promptly report and resolve problems regarding performance and/or conformity with the drawings and specifications, including contract administration and construction engineering of the assigned project. Assist the County staff managing construction operations. In accordance with the State Standard Specifications and Special Provisions, ensure that all utility work is coordinated with the appropriate utility company and that all the appropriate permits and inspections are obtained for all items of work.

Change Orders: In accordance with State Standard Specifications, and Special Provisions and the County format for construction contract change orders, prepare, process, and make recommendations on change orders. County shall review and approve all change orders.

Environmental Compliance: Coordinate and supervise pre-construction biological survey(s) and environmental monitoring. CONTRACTOR shall provide environmental monitoring and surveying services. CONTRACTOR shall provide County with regulatory permit reports documenting the results of each survey and compliance with the permit requirements. CONTRACTOR shall be qualified to survey and relocate California Red Legged Frog and Steelhead.

Surveying: Coordinate and supervise construction surveying and staking. CONTRACTOR shall have a licensed land surveyor provide construction staking services.

Material Testing: Coordinate, interpret, certify, and supervise all required soils and material tests in accordance with **County's Quality Assurance Plan (QAP)**, and Caltrans test methods and Standard Specifications. CONTRACTOR shall provide County with a Caltrans certified material testing company to provide materials testing services per Caltrans Standard Specifications.

Test Data: Review and approve copies of certificates of compliance, independent testing laboratory reports, and manufacturer's shop or mill tests to ensure conformance with contract specifications.

Plan Interpretation: With the assistance of County Engineer, as needed, interpret the intent of the plans and specifications to protect County against defects and deficiencies in construction on the part of the construction contractor.

Pre-Construction Conference: Assist in the pre-construction meeting with the construction contractor and other Project participants. This discussion affords all the parties of the contract a common understanding of the proposed work and problems, and possible solutions that may be expected during the life of the contract. Labor compliance, equal employment opportunity, safety requirements, **DBE requirements**, water pollution requirements, agreements, and permits shall also be discussed. Respond to questions the construction contractor may have and address issues that need to be resolved before work commences.

Safety and Accidents: Assume the duties of the Project Safety Coordinator. Ensure the construction contractor complies with all safety orders, Federal and State, and permits through normal contract administration procedures. Document all incidents with photographs and written reports. Manage safety precautions through the construction contractor for the public in construction areas.

Approval Schedule: Prepare a schedule (using Microsoft Project) indicating all items that will be submitted by the construction contractor for review and approval requiring action by County. Furnish appropriate forms, as necessary, and monitor the construction contractor's adherence to the schedule.

False Work and Shop Drawings: Manage and maintain records, provide timely engineering review, and prepare written recommendations certifying the adequacy of the construction contractor's submittal for false work as well as construction of false work. Coordinate, document, and make engineering recommendations in writing on approval of shop drawings. Final submittal approvals shall be made in consultation with County.

Progress Statements: Prepare and provide monthly progress statements meeting County requirements including the following: monthly estimates of all items of work with source documents to verify progress payments. Submit weekly copies of daily diaries to County. Submit a copy of the baseline progress schedule and monthly updates as required by the Special Provisions.

Final Walk-through and Final Inspection: Conduct Project walk-throughs prior to completion of construction. Minutes of the walk-through(s) shall be completed by CONTRACTOR and a copy shall be provided to County. The final walk-through list of attendees shall be coordinated with County. CONTRACTOR shall complete a final inspection of the Project and complete the required Final Report forms.

As-Built Plans: Provide County with an electronic as-built plan file complete with redline changes or corrections. Such plans will be based upon information obtained from field measurements and observations made during project construction and approved contract change orders. The electronic signature and seal of the responsible Registered Resident Engineer or Construction Engineer shall be placed in the file on Level 62 (refer to "Highway Design and Topography Information" on Page 2.5-2 of the *Caltrans CADD Users Manual*).

Contract Records: At the completion of the Project, submit the original set of construction books to the County cataloged in accordance with Chapter 5, Section 5-102, "Organization of Project Documents," of the *Caltrans Construction Manual* and as directed by County. These records shall include all correspondence, meeting minutes, photographs, agreements, hazardous waste material information and tests, labor compliance, contract administration forms, bridge work, diaries, contract

item quantity documents, contract change orders, project status sheets, project record-estimate and project status, disputes, project completion documents, etc.

Constructability Review: CONTRACTOR shall review the final plans and specifications prior to start of Project construction, (or if time permits prior to the advertisement construction contract) and provide County with recommendations to improve the Project documents.

6.5 **Construction Schedule:** Construction contract is expected to be awarded in the Spring of 2022 and Project construction will begin as allowed by the regulatory permit.

6.6 COVID-19: Under the Monterey County Shelter in Place Order initially issued on March 17, 2020, further revised on June 22, 2020, and most recently revised on December 9, 2020, construction is identified as an essential business. Construction activity is permitted to continue in accordance with local Monterey County Shelter in Place Order and the California Department of Public Health and the State of California Department of Industrial Relations Occupational Safety and Health Administration (CAL-OSHA) Industry Guidance for Construction issued on July 2, 2020.

Please be advised that **all CONTRACTORS** selected to provide essential services and any persons/entities authorized by said CONTRACTOR to visit County of Monterey work sites must comply with required COVID-19 health and safety measures including implementation of a COVID-19 prevention plan. Key business practices shall include physical distancing to the maximum extent possible, use of face coverings, frequent handwashing and regular cleaning and disinfecting, and training employees on these and other elements of their COVID-19 prevention plan. Prospective bidders are advised to review the Monterey County COVID-19 website for more information on required COVID-19 health and safety measures: <https://www.co.monterey.ca.us/government/departments-a-h/health/diseases/2019-novel-coronavirus-2019-ncov/health-officer-shelter-in-place-order>.

7.0 REQUIRED CONTENT/FORMAT FOR PROPOSAL PACKAGE

7.1 Content and Layout:

CONTRACTOR shall provide the information as requested and as applicable to the proposed services. The proposal shall be organized in the order of and as per the listing below. The proposal shall include, at a minimum but is not limited to, the following information below in the format indicated. Each attachment must be clearly labeled **in the upper right corner RFP #10807 - Attachment "X"**.

7.2 Cover Letter:

All proposals packages must be accompanied by a cover letter not exceeding two (2) pages providing firm and contact information as follows:

7.2.1. **Firm Information:** Description of the type of organization (e.g., corporation, partnership, including joint venture teams and subcontractors) and how many years in existence. Indicate any planned or anticipated changes in business organization or operations, such as dissolution, winding-up, merger, etc., that may bear on the ability to complete services in accordance with County's AGREEMENT.

7.2.2. **Contact Information:** Name, mailing address, telephone number, and e-mail address of CONTRACTOR's primary contact person during the solicitation process through potential AGREEMENT award.

7.3 Signed RFP Signature Page: (Attachment A)

Proposals submitted without the RFP signature page (provided in Appendix I) will be deemed non-responsive. All signatures must be manual and in BLUE ink. All notations must be typed or written in BLUE ink. Errors may be crossed out and corrections printed in BLUE ink or typed adjacent to said correction and must be initialed in BLUE ink by the person signing the proposal package.

7.4 Signed Addenda: (Attachment B) (Include all addenda, if any, released for this solicitation)

Proposals submitted without this (these) page(s) will be deemed non-responsive. All signatures must be manual and in BLUE ink. All prices and notations must be typed or written in BLUE ink. Errors may be crossed out and corrections printed in BLUE ink or typed adjacent to said correction and must be initialed in BLUE ink by the person signing the proposal package.

7.5 General Firm Information: (Attachment C)

Prepare an Attachment C (label as required) providing a general information summary about your firm which, at minimum, includes the information following the outline provided below:

7.5.1 Firm Name and Address

Year Established

Enter the year the firm (or branch office, if appropriate) was established under current name.

7.5.2 Data Universal Numbering System (DUNS) Number

Provide DUNS number issued by Dun and Bradstreet Information services. Firms must have a DUNS number.

7.5.3 Ownership Type

Enter the type of ownership or legal structure of the firm (sole proprietor, partnership, corporation, joint venture, etc.).

7.5.4 Point of Contact

Provide the point of contact information for a representative of the firm that County can contact for additional information. Representative must be authorized to speak on contractual and policy matters.

7.5.5 Former Firm Name(s)

If any, indicate all previous firm (or branch office) name(s) during the last five (5) years. Indicate the year that any and all corporate name change or changes was/were effective and the associated DUNS number. This information is used to review past performance on Federal contracts.

7.5.6 Employee by Discipline

Specify all staff members of the Project team, their job titles, and their area of specialty, including licenses and/or certifications they may hold.

7.5.7 Litigation History

Provide a description of litigation to which your firm has been a party to in the past five (5) years. Please include the following details:

- Name of Case/Court Case Number
- Date Filed
- Court in which Filed
- Judgment or Result

7.6 **Organizational Chart of Proposed Team: (Attachment D)**

Provide an Attachment D illustrating your firm's organizational chart. The chart should show the names and roles of all key personnel and the firm they are associated with if they are a subcontractor. The chart should provide a clear picture of the working relationship between all key personnel on the proposed team.

7.7 **Resume(s) of Key Personnel for Project: (Attachment E)**

Provide as Attachment E, resume(s) for each key person on the proposed team. County will be looking at each proposed team member's relevant technical expertise to provide construction management tasks listed in the County Scope of Work in Section 6.0. County will also check that key personnel have appropriate licenses, registrations, and certifications to provide road engineering tasks listed in Scope of Work in Section 6.0, and that some or all team members (firms) have previously worked together on similar projects.

7.8 **Project Experience & References: (Attachment F)**

7.8.1 Prepare an Attachment F providing project information and include three (3) examples of construction projects relevant to Monterey County within the last five (5) years, demonstrating work experience with Local, State and Federal agencies. For each project, the following shall be provided:

- **Project Name**
- **Brief Project Description**
Please include information about scope, schedule, and record of performance. The description should also discuss the entire project delivery team, i.e., subcontractors and their respective roles. Project information should discuss the type of CEQA/NEPA document prepared for the project as well as the regulatory permits obtained.
- **Size of Project**
- **Name of General Contractor on Project**
- **Project Challenges or Complexities**
- **CONTRACTOR'S staff and subconsultants assigned to Project**

Include any experience with Caltrans Local Assistance Office or community outreach efforts during the construction of the Project.

7.8.2 References: CONTRACTOR shall describe at least three (3) similar projects for which it provided services similar to the services described in Section 6.0, Scope of Work. For each reference, the following shall be provided:

- **Project Name**
- **Brief Project Description**
Please include information about scope, schedule, and record of performance. The description should also discuss the entire project delivery team, i.e., subcontractors and their respective roles.
- **Client Name**
- **Client Contact Information**

Please include telephone number and e-mail address of the Firm's Project Manager.

7.9 Project Management Approach (one [1] page Limit): (Attachment G)

Provide as Attachment G, a description of the approach and the steps and methods used to ensure Project is constructed to the approved plans and specifications. Methods or steps used to minimize Project change orders and claims.

7.10 Schedule Management Approach (one [1] page Limit): (Attachment H)

Provide as Attachment H, a description of schedule management approach; scheduling software used, and methods used to recover from slippage of schedule milestones; progress meetings with CONTRACTOR, system to track timely review of submittals and Request for Information (RFI's).

7.11 Fee Schedule: (Attachment I) (submit in separate sealed envelope)

CONTRACTOR shall complete Appendix IV, Exhibit 10-H2 Cost Proposal **and LAPM Exhibit 10-01 Consultant Proposal DBE Commitment** and submit within their qualifications package. Fees may be negotiated after the tentative award announcement is made for this solicitation. If fee negotiations with the firm determined most qualified are not successful, and/or the fees discussed are outside the budgetary constraints for the Project, County reserves the right to suspend negotiations with the most qualified firm, and proceed to second most qualified firm, and so on.

Selection of CONTRACTOR shall be based on qualifications per the Selection Criteria listed herein.

7.12 Exceptions Submittal (if applicable)

Submit any and all exceptions to this solicitation on separate pages, and clearly identify at the top of each page, "EXCEPTION TO COUNTY RFP #10807". Each exception shall reference the page number and section number, as appropriate. CONTRACTOR should note that the submittal of an exception does not obligate County to revise the terms of the RFP or AGREEMENT.

7.13 Appendix:

CONTRACTOR may provide any additional information that it believes to be applicable to this proposal package and include such information in an Appendix section.

8.0 SUBMITTAL INSTRUCTIONS & CONDITIONS

8.1 Submittal Identification Requirements: ALL SUBMITTALS MAILED OR DELIVERED CONTAINING PROPOSAL MUST BE SEALED AND BEAR ON THE OUTSIDE, PROMINENTLY DISPLAYED IN THE LOWER LEFT CORNER: **THE SOLICITATION NUMBER RFP # 10807 and CONTRACTOR'S FIRM NAME.** CONTRACTOR MUST INCLUDE ONE (1) ORIGINAL HARD COPY, TWO (2) COPIES, AND ONE (1) CD OR THUMB DRIVE WITH PDF FILES OF SUBMITTAL MATERIALS; AND ONE (1) ORIGINAL ATTACHMENT I (Fee Schedule/Appendix IV, Exhibit 10 H-2 Cost Proposal) IN A SEPARATE SEALED ENVELOPE.

8.2 Mailing Address: Proposals shall be mailed to County Point of Contact at the mailing address indicated on RFP Signature Page.

8.3 Due Date: Proposal packages must be received by County ON OR BEFORE the time and date specified in Section 4.0, Calendar of Events. It is the sole responsibility of CONTRACTOR to ensure that the proposal package is received by or before the specified time. Postmarks and facsimiles are not acceptable. Proposal packages received after the deadline shall be rejected and returned unopened.

- 8.4 **Shipping Costs:** Unless stated otherwise, the Free on Board (FOB) for receivables shall be destination. Charges for transportation, containers, packaging, and other related shipping costs shall be borne by the sender.
- 8.5 **Acceptance:** Proposals are subject to acceptance at any time within ninety (90) days after opening. County reserves the right to reject any and all proposal packages, or part of any proposal package, to postpone the scheduled deadline date(s), to make an award in its own best interest, and to waive any informalities or technicalities that do not significantly affect or alter the substance of an otherwise responsible proposal package and that would not affect a CONTRACTOR's ability to perform the work adequately as specified.
- 8.6 **Ownership:** All submittals in response to this solicitation become the property of County.
- 8.7 **Compliance:** Proposal packages that do not follow the format, content and submittal requirements as described herein, or fail to provide the required documentation, may receive lower evaluation scores or be deemed non-responsive.
- 8.8 **CAL-OSHA:** The items proposed shall conform to all applicable requirements of the CAL-OSHA Act of 1973.

9.0 SELECTION CRITERIA

- 9.1 The selection of CONTRACTOR and subsequent AGREEMENT award will be based on the criteria contained in this RFP, as demonstrated in the submitted proposal package. CONTRACTOR should submit information sufficient for the County to easily evaluate proposals with respect to the selection criteria. The absence of required information may cause the proposal to be deemed non-responsive and may be cause for rejection.
- 9.2 The scoring criteria includes the following:

CRITERIA	Scoring Criteria
Proposed Team Qualifications and Resume (0-40 points)	Points
Organizational Chart of Proposed Team provides a clear picture of the working relationship between all key personnel on the proposed team	
Proposed team members have relevant technical expertise to provide engineering inspection services, material testing, and surveying and construction staking tasks listed in County Scope of Work in Section 6.0	
Staff has appropriate licenses, registrations, and certifications to provide engineering task listed in County Scope of Work in Section 6.0	
Some or all team members/firms have previously worked together on similar projects	
Proposed Team Qualifications and Resume Subtotal Possible Points - 40	
Project Experience (0-30 points)	Points

<p>Example Project 1 description indicates (0-10 points):</p> <ol style="list-style-type: none"> (1) Previous experience with project of similar scope and/or complexity; (2) Specific role the team member(s) had in the project; (3) Project funding and funding reporting requirements; (4) Experience with complying with approved environmental CEQA/NEPA document as well as regulatory permits obtained for the project; (5) Construction contractor change orders negotiated and approved; (6) Project documentation and file management system used; (7) Conformance to project's construction schedule and budget; 	
<p>Example Project 2 description indicates (0-10 points):</p> <ol style="list-style-type: none"> (1) Previous experience with project of similar scope and/or complexity; (2) Specific role the team member(s) had in the project; (3) Project funding and funding reporting requirements; (4) Experience with complying with approved environmental CEQA/NEPA document as well as regulatory permits obtained for the project; (5) Construction contractor change orders negotiated and approved; (6) Project documentation and file management system used; (7) Conformance to project's construction schedule and budget; 	
<p>Example Project 3 description indicates (0-10 points):</p> <ol style="list-style-type: none"> (1) Previous experience with project of similar scope and/or complexity; (2) Describe the specific role the team member(s) had in the project; (3) Project funding and funding reporting requirements; (4) Experience with complying with approved environmental CEQA/NEPA document as well as regulatory permits obtained for the project; (5) Construction contractor change orders negotiated and approved; (6) Project documentation and file management system used; (7) Conformance to project's construction schedule and budget; 	
Project Experience Subtotal Possible Points – 30	
Experience with Caltrans Local Assistance (0-15 points)	Points
Firm's proposed project team has experience with Caltrans Local Assistance procedures.	
Client References (0-5 points)	Points
List of recent client references	
Project Specific Quality Components:	
Project Management Approach as described (one [1] page limit) (0-5 points)	Points
Describes approach and the steps and methods used to ensure project is constructed to the approved plans and specifications. Methods or steps used to minimize project change orders and claims.	
Schedule Management Approach as described (one [1] page limit) (0-5 points)	Points
Describes schedule management approach; scheduling software used, and methods used to recover from slippage of schedule milestones; progress meetings with contractor, system to track timely review of submittals and request for information (RFI's).	
Project Management and Schedule Management Approach Subtotal Possible Points - 10	

Total (100 Points Possible)	
------------------------------------	--

9.3 AGREEMENT award will not be based on cost alone.

9.4 County may conduct interviews and utilize references during selection process as well.

9.5 The award resulting from this RFP will be made to the CONTRACTOR that submits a response that, in the sole opinion of County, best serves the overall interest of County.

9.6 The award made from this RFP is subject to approval by the County Board of Supervisors.

10.0 AGREEMENT AWARD

10.1 No Guaranteed Value: County does not guarantee a minimum or maximum dollar value for any AGREEMENT resulting from this solicitation.

10.2 Board of Supervisors: The award made from this solicitation is subject to approval by County Board of Supervisors.

10.3 Interview: County reserves the right to interview selected CONTRACTOR before an AGREEMENT is awarded. The costs of attending any interview are CONTRACTOR's responsibility.

10.4 Incurred Costs: County is not liable for any cost incurred by CONTRACTOR in response to this solicitation.

10.5 Notification: All CONTRACTORS who have submitted a Proposal package will be notified of the final decision as soon as it has been determined.

10.6 In County's Best Interest: The award resulting from this solicitation will be made to the CONTRACTOR that submits a response that, in the sole opinion of County, best serves the overall interest of County.

11.0 SEQUENTIAL AGREEMENT NEGOTIATION

11.1 County will pursue AGREEMENT negotiations with CONTRACTOR who submits the best proposal or is deemed the most qualified in the sole opinion of County, and which is in accordance with the criteria as described within this solicitation. If the AGREEMENT negotiations are unsuccessful, in the opinion of either County or CONTRACTOR, County may pursue AGREEMENT negotiations with the entity that submitted a proposal which County deems to be the next best qualified to provide the services, or County may issue a new solicitation, or take any other action which it deems to be in its best interest.

12.0 AGREEMENT TERMS AND CONDITIONS

12.1 The term of the AGREEMENT will be for a period of three (3) years with the option to extend the AGREEMENT for two (2) additional one (1) year periods.

12.1.1 County does not have to give a reason if it elects not to extend or renew the AGREEMENT.

12.2 AGREEMENT shall contain a clause that provides that County reserves the right to cancel the AGREEMENT, or any extension of the AGREEMENT, without cause, with a thirty (30)-day written notice, or immediately, with cause.

12.3 If this RFP includes options for renewal or extensions, CONTRACTOR must commence negotiations for rate changes a minimum of ninety (90) days prior to the expiration of the AGREEMENT. Both parties shall agree upon rate extensions or changes in writing.

12.4 CONTRACTOR selected through the solicitation process will be expected to execute a formal AGREEMENT with County for the provision of the requested service. The AGREEMENT shall be written by County in a standard format approved by the Office of the County Counsel-Risk Management, substantially similar to the “**SAMPLE AGREEMENT**” provided in Appendix II. Submission of a signed proposal package and the **RFP SIGNATURE PAGE** will be interpreted to mean CONTRACTOR HAS AGREED TO ALL THE TERMS AND CONDITIONS set forth **in the pages of this solicitation and the standard provisions included in the AGREEMENT**. County may but is not required to consider including language from the CONTRACTOR’s proposed AGREEMENT, and any such submission shall be included in the EXCEPTIONS submittal of CONTRACTOR’s proposal.

13.0 COLLUSION

13.1 CONTRACTOR shall not conspire, attempt to conspire, or commit any other act of collusion with any other interested party for the purpose of secretly, or otherwise, establishing an understanding regarding rates or conditions to the solicitation that would bring about any unfair conditions.

14.0 RIGHTS TO PERTINENT MATERIALS

14.1 All responses, inquiries, and correspondence related to this solicitation and all reports, charts, displays, schedules, exhibits, and other documentation produced by the CONTRACTOR that are submitted as part of the submittal will become the property of County when received by the County and may be considered public information under applicable law. Any proprietary information in the submittal must be identified as such and marked “CONFIDENTIAL INFORMATION” or “PROPRIETARY INFORMATION”. County will not disclose proprietary information to the public, unless required by law; however, County cannot guarantee that such information will be held confidential.

As a California government entity, County is subject to the California Public Records Act (CPRA) and other public transparency laws and, as such, cannot guarantee the confidentiality of information marked confidential or proprietary. County will respond to requests for disclosure of records related to this solicitation in accord with applicable law on disclosure requirements and exemptions to disclosure.

15.0 INDEMNIFICATION

15.1 For purposes of the following indemnification provisions (“Indemnification Agreement”), “design professional” has the same meaning as set forth in California Civil Code section 2782.8. If any term, provision or application of this Indemnification Agreement is found to be invalid, in violation of public

policy or unenforceable to any extent, such finding shall not invalidate any other term or provision of this Indemnification Agreement and such other terms and provisions shall continue in full force and effect. If there is any conflict between the terms, provisions or application of this Indemnification Agreement and the provisions of California Civil Code Sections 2782 or 2782.8, the broadest indemnity protection for the County under this indemnification Agreement that is permitted by law shall be provided by CONTRACTOR.

15.2 Indemnification for Design Professional Services Claims:

CONTRACTOR shall indemnify, defend and hold harmless County, its governing board, directors, officers, employees, and agents against any claims that arise out of, or pertain to, or relate to the negligence, recklessness, or willful misconduct of the CONTRACTOR, its employees, subcontractors, and agents in the performance of design professional services under this AGREEMENT, excepting only liability arising from the sole negligence, active negligence or willful misconduct of the County, or defect in a design furnished by the County, but in no event shall the amount of such CONTRACTOR's liability exceed such CONTRACTOR's proportionate percentage of fault as determined by a court, arbitrator or mediator, or as set out in a settlement agreement. In the event one (1) or more defendants to any action involving such claim or claims against County is unable to pay its share of defense costs due to bankruptcy or dissolution of the business, such CONTRACTOR shall meet and confer with the other parties to such action regarding unpaid defense costs.

15.3 Indemnification for All Other Claims or Loss:

For any claim, loss, injury, damage, expense or liability other than claims arising out of the CONTRACTOR's performance of design professional services under this AGREEMENT, CONTRACTOR shall indemnify, defend and hold harmless County, its governing board, directors, officers, employees, and agents against any claim for loss, injury, damage, expense or liability resulting from or alleging injury to or death of any person or loss of use of or damage to property, arising from or related to the performance of services under this AGREEMENT by CONTRACTOR, its employees, subcontractors or agents, excepting only liability arising from the sole negligence, active negligence or willful misconduct of the County, or defect in a design furnished by the County.

16.0 INSURANCE REQUIREMENTS

16.1 Evidence of Coverage:

Prior to commencement of AGREEMENT, CONTRACTOR shall provide a "Certificate of Insurance" certifying that coverage as required herein has been obtained. Individual endorsements executed by the insurance carrier shall accompany the certificate. In addition, CONTRACTOR upon request shall provide a certified copy of the policy or policies.

This verification of coverage shall be sent to the County's Contracts/Purchasing Division, unless otherwise directed. CONTRACTOR shall not receive a "Notice to Proceed" with the work under AGREEMENT until it has obtained all insurance required and County has approved such insurance. This approval of insurance shall neither relieve nor decrease the liability of the CONTRACTOR.

16.2 Qualifying Insurers:

All coverages, except surety, shall be issued by companies which hold a current policy holder's alphabetic and financial size category rating of not less than A- VII, according to the current Best's Key Rating Guide or a company of equal financial stability that is approved by the County's Contracts/Purchasing Officer.

16.3 Insurance Coverage Requirements:

Without limiting CONTRACTOR's duty to indemnify, CONTRACTOR shall maintain in effect throughout the term of the AGREEMENT a policy or policies of insurance with the following minimum limits of liability:

Commercial General Liability Insurance, including but not limited to premises and operations, including coverage for Bodily Injury and Property Damage, Personal Injury, Contractual Liability, Broad form Property Damage, Independent Contractors, Products and Completed Operations, with a combined single limit for Bodily Injury and Property Damage of not less than \$1,000,000 per occurrence.

(Note: any proposed modifications to these general liability insurance requirements shall be attached as an Exhibit hereto, and the section(s) above that are proposed as not applicable shall be lined out in blue ink. All proposed modifications are subject to County approval.)

Business Automobile Liability Insurance, covering all motor vehicles, including owned, leased, non-owned, and hired vehicles, used in providing services under this AGREEMENT, with a combined single limit for Bodily Injury and Property Damage of not less than \$1,000,000 per occurrence.

(Note: any proposed modifications to these auto insurance requirements shall be attached as an Exhibit hereto, and the section(s) above that are proposed as not applicable shall be lined out in blue ink. All proposed modifications are subject to County approval.)

Workers' Compensation Insurance, if CONTRACTOR employs others in the performance of this AGREEMENT, in accordance with California Labor Code section 3700 and with Employer's Liability limits not less than \$1,000,000 each person, \$1,000,000 each accident and \$1,000,000 each disease.

(Note: any proposed modifications to these workers' compensation insurance requirements shall be attached as an Exhibit hereto, and the section(s) above that are proposed as not applicable shall be lined out in blue ink. All proposed modifications are subject to County approval.)

Professional Liability Insurance, if required for the professional services being provided, (e.g., those persons authorized by a license to engage in a business or profession regulated by the California Business and Professions Code), in the amount of not less than \$1,000,000 per claim and \$2,000,000 in the aggregate, to cover liability for malpractice or errors or omissions made in the course of rendering professional services. If professional liability insurance is written on a "claims-made" basis rather than an occurrence basis, the CONTRACTOR shall, upon the expiration or earlier termination of this AGREEMENT, obtain extended reporting coverage ("tail coverage") with the same liability limits. Any such tail coverage shall continue for at least three (3) years following the expiration or earlier termination of this AGREEMENT.

(Note: any proposed modifications to these insurance requirements shall be attached as an Exhibit hereto, and the section(s) above that are proposed as not applicable shall be lined out in blue ink. All proposed modifications are subject to County approval.)

16.4 Other Requirements:

All insurance required by the PSA shall be with a company acceptable to County and issued and executed by an admitted insurer authorized to transact Insurance business in the State of California. Unless otherwise specified by this Agreement, all such insurance shall be written on an occurrence basis, or, if the policy is not written on an occurrence basis, such policy with the coverage required herein shall continue in effect for a period of three (3) years following the date CONTRACTOR completes its performance of services under this AGREEMENT.

Each liability policy shall provide that the County shall be given notice in writing at least thirty (30) days in advance of any endorsed reduction in coverage or limit, cancellation, or intended non-renewal thereof. Each policy shall provide coverage for CONTRACTOR and additional insureds with respect to claims arising from each subcontractor, if any, performing work under this AGREEMENT, or be accompanied by a certificate of insurance from each subcontractor showing each subcontractor has identical insurance coverage to the above requirements.

Commercial general liability and automobile liability policies shall provide an endorsement naming the County of Monterey, its officers, agents, and employees as Additional Insureds with respect to liability arising out of the CONTRACTOR'S work, including ongoing and completed operations, **and shall further provide that such insurance is primary insurance to any insurance or self-insurance maintained by the County and that the insurance of the Additional Insureds shall not be called upon to contribute to a loss covered by the CONTRACTOR'S insurance.** The required endorsement form for Commercial General Liability Additional Insured is **ISO Form CG 20 10 11-85 or CG 20 10 10 01 in tandem with CG 20 37 10 01 (2000).** The required endorsement form for Automobile Additional Insured endorsement is **ISO Form CA 20 48 02 99.**

Prior to the execution of this AGREEMENT by the County, CONTRACTOR shall file certificates of insurance with County Contract Administrator and County Contracts/Purchasing Division, showing that the CONTRACTOR has in effect the insurance required by this AGREEMENT. CONTRACTOR shall file a new or amended certificate of insurance within five (5) calendar days after any change is made in any insurance policy, which would alter the information on the certificate then on file. Acceptance or approval of insurance shall in no way modify or change the indemnification clause in this AGREEMENT, which shall continue in full force and effect.

CONTRACTOR shall at all times during the term of this AGREEMENT maintain in force the insurance coverage required under this AGREEMENT and shall send, without demand by County, annual certificates to County Contract Administrator and County Contracts/Purchasing Division. If the certificate is not received by the expiration date, County shall notify CONTRACTOR and CONTRACTOR shall have five (5) calendar days to send in the certificate, evidencing no lapse in coverage during the interim. Failure by CONTRACTOR to maintain such insurance is a default of this AGREEMENT, which entitles County, at its sole discretion, to terminate this AGREEMENT immediately.

APPENDIX I: SIGNATURE PAGE

COUNTY OF MONTEREY	RFP #10807
DEPARTMENT OF PUBLIC WORKS, FACILITIES, & PARKS	ISSUE DATE: March 17, 2022
	
RFP TITLE: Construction Management Services for the Robinson Canyon Road Bridge Scour Repair Project	
PROPOSALS ARE DUE AT THE DEPARTMENT OF PUBLIC WORKS, FACILITIES, & PARKS BY 3:00 P.M., LOCAL TIME, ON FRIDAY, April 22, 2022	MAILING ADDRESS: COUNTY OF MONTEREY DEPARTMENT OF PUBLIC WORKS, FACILITIES, & PARKS 1441 Schilling Place, South 2nd Floor SALINAS, CA 93901-4527
QUESTIONS ABOUT THIS RFP SHOULD BE DIRECTED TO Enrique Saavedra, saavedraem@co.monterey.ca.us	
CONTRACTOR MUST INCLUDE THE FOLLOWING IN EACH PROPOSAL: <ul style="list-style-type: none"> • Proposal (as required by this RFP) – One (1) original hard copy, two (2) copies, and one (1) CD or thumb drive with PDF files of submittal • Fee Schedule (Attachment I) – One (1) original hard copy, sealed in a separate envelope 	
<input type="checkbox"/> ALL REQUIRED CONTENT AS DEFINED PER SECTION 8.1 HEREIN	
This Signature Page must be included with your submittal in order to validate your proposal. Proposals submitted without this page will be deemed non-responsive.	
<input type="checkbox"/> CHECK HERE IF YOU HAVE ANY EXCEPTIONS TO THIS SOLICITATION.	
CONTRACTOR MUST COMPLETE THE FOLLOWING TO VALIDATE PROPOSAL	
I hereby agree to furnish the articles and/or services stipulated in my proposal at the price quoted, subject to the instructions and conditions in the RFP. I further attest that I am an official officer representing my firm and authorized with signatory authority to present this proposal package.	

Firm Name: _____ Date _____

Signature: _____ Printed Name and Title: _____

Street Address: _____

City: _____ State: _____ Zip: _____

Phone: () _____ Email: _____

License No. (If applicable): _____

License Classification (If applicable): _____

APPENDIX II: SAMPLE AGREEMENT

The County of Monterey Agreement for Professional Services with Surveyors, Architects, Engineers & Design Professionals (More than \$100,000) with all terms and conditions may be viewed at:

[http://www2.co.monterey.ca.us/cao/pdfs/PSA_DesignProf_over\\$100k.pdf](http://www2.co.monterey.ca.us/cao/pdfs/PSA_DesignProf_over$100k.pdf)

APPENDIX III: EXHIBIT B FEDERAL PROVISIONS

In compliance with this RFP #10807, which uses Federal Highway Administration (FHWA) funds, the CONTRACTOR will be required to comply with Federal provisions. Federal Provisions, Exhibit B, attached hereto, shall be completed by CONTRACTOR and submitted to County for approval prior to County issuing CONTRACTOR a Notice to Proceed for the Project.

Appendix III
EXHIBIT B – FEDERAL PROVISIONS
CALTRANS LOCAL ASSISTANCE PROCEDURES MANUAL

In compliance with this _____, which uses Federal Highway Administration (FHWA) funds, the CONTRACTOR (also referred to as “Consultant”) will be required to comply with Federal Provisions. Federal Provisions, Exhibit B, attached hereto, shall be completed by CONTRACTOR (Consultant) and submitted to COUNTY (also referred to as “Local Agency”) for approval prior to COUNTY (Local Agency) issuing a Notice to Proceed for the Project to CONTRACTOR (Consultant).

Appendix III
EXHIBIT B – FEDERAL PROVISIONS
CALTRANS LOCAL ASSISTANCE PROCEDURES MANUAL

Table of Contents

Article I - Introduction	3
Article II Contractor’s Reports or Meetings	4
Article III Statement of Work.....	5
Article IV Performance Period.....	6
Article V Allowable Costs and Payments (Verbatim)	7
Article VI Termination	11
Article VII Cost Principles and Administrative Requirements (Verbatim)	12
Article VIII Retention of Records/Audit	13
Article IX Audit Review Procedures	13
Article X Subcontracting.....	15
Article XI Equipment Purchase and Other Capital Expenditures (Verbatim)	17
Article XII State Prevailing Wage Rates.....	17
Article XIII Conflict of Interest (Verbatim).....	21
Article XIV Rebates, Kickbacks or other Unlawful Consideration (Verbatim)	22
Article XV Prohibition of Expending County, State, or Federal Funds for Lobbying (Verbatim)	22
Article XVII Debarment and Suspension Certification	24
Article XVIII Disadvantaged Business Enterprises (DBE) Participation.....	24
Article XIX Insurance.....	28
Article XX Funding Requirements	29
Article XXI Change in Terms.....	29
Article XXI Contingent Fee	30
Article XXII Disputes.....	30
Article XXIV Inspection of Work.....	30
Article XXV Safety.....	31
Article XXVI Ownership of Data	31
Article XXVII Claims Filed by County’s Construction Contractor.....	32
Article XXVIII Confidentiality of Data	32
Article XXIX National Labor Relations Board Certification	33
Article XXX Evaluation of Contractor.....	33
Article XXXI Prompt Payment from the County to the Contractor.....	33
ARTICLE XXXII NOTIFICATION.....	33
ARTICLE XXXIII CONTRACT	34
ARTICLE XXXIV SIGNATURES	34
CALTRANS LOCAL ASSISTANCE PROCEDURES MANUAL FORMS	35

Appendix III
EXHIBIT B – FEDERAL PROVISIONS
CALTRANS LOCAL ASSISTANCE PROCEDURES MANUAL

Article I - Introduction

This AGREEMENT is between the following named, hereinafter referred to as, CONTRACTOR and the following named, hereinafter referred to as, COUNTY:

The name of the “CONTRACTOR” is as follows:

Incorporated in the State of California

The Project Manager for the “CONTRACTOR” will be:

The name of the COUNTY is as follows:

County of Monterey
Department of Public Works, Facilities, & Parks
1441 Schilling Place, South 2nd Floor
Salinas, CA 93901-4527

The Contract Administrator for COUNTY will be:

- B. The work to be performed under this AGREEMENT is described in Article III Statement of Work and the approved CONTRACTOR’s Cost Proposal dated _____. The approved CONTRACTOR’s Cost Proposal is attached hereto (_____) and incorporated by reference. If there is any conflict between the approved Cost Proposal and this AGREEMENT, this AGREEMENT shall take precedence.
- C. CONTRACTOR agrees to the fullest extent permitted by law, to indemnify, protect, defend, and hold harmless COUNTY, its officers, officials, agents, employees and volunteers from and against any and all claims, damages, demands, liability, costs, losses and expenses, including without limitation, court costs and reasonable attorneys’ and expert witness fees, arising out of any failure to comply with applicable law, any injury to or death of any person(s), damage to property, loss of use of property, economic loss or otherwise arising out of the performance of the work described herein, to the extent caused by a negligent act or negligent failure to act, errors, omissions, recklessness or willful misconduct incident to the performance of this AGREEMENT on the part of CONTRACTOR, except such loss or damage which was caused by the sole negligence, or willful misconduct of COUNTY, as determined by a Court of competent jurisdiction. The provisions of this section shall survive termination or suspension of this AGREEMENT.
- D. CONTRACTOR in the performance of this AGREEMENT, shall act in an independent capacity. It is understood and agreed that CONTRACTOR (including CONTRACTOR's employees) is an independent contractor and that no relationship of employer-employee exists between the Parties hereto. CONTRACTOR's assigned personnel shall not be entitled to any benefits payable to employees of COUNTY.
- E. COUNTY is not required to make any deductions or withholdings from the compensation payable to CONTRACTOR under the provisions of the AGREEMENT, and is not required to issue W-2 Forms for income and employment tax purposes for any of CONTRACTOR's assigned personnel. CONTRACTOR, in the performance of its obligation hereunder, is only subject to the control or direction of the COUNTY as to the designation of tasks to be performed and the results to be accomplished.
- F. Any third party person(s) employed by CONTRACTOR shall be entirely and exclusively under the direction, supervision, and control of CONTRACTOR. CONTRACTOR hereby indemnifies and holds COUNTY harmless from any and all claims that may be made against COUNTY based upon any contention by any third party that an

Appendix III
EXHIBIT B – FEDERAL PROVISIONS
CALTRANS LOCAL ASSISTANCE PROCEDURES MANUAL

employer-employee relationship exists by reason of this AGREEMENT.

- G. Except as expressly authorized herein, CONTRACTOR 's obligations under this AGREEMENT are not assignable or transferable, and CONTRACTOR shall not subcontract any work, without the prior written approval of the COUNTY. However, claims for money due or which become due to CONTRACTOR from City under this AGREEMENT may be assigned to a financial institution or to a trustee in bankruptcy, without such approval. Notice of any assignment or transfer whether voluntary or involuntary shall be furnished promptly to the COUNTY.
- H. CONTRACTOR shall be as fully responsible to the COUNTY for the negligent acts and omissions of its contractors and subconsultants or subcontractors, and of persons either directly or indirectly employed by them, in the same manner as persons directly employed by CONTRACTOR.
- I. No alteration or variation of the terms of this AGREEMENT shall be valid, unless made in writing and signed by the parties authorized to bind the parties; and no oral understanding or agreement not incorporated herein, shall be binding on any of the parties hereto.
- J. The consideration to be paid to CONTRACTOR as provided herein, shall be in compensation for all of CONTRACTOR's expenses incurred in the performance hereof, including travel and per diem, unless otherwise expressly so provided.

Article II Contractor's Reports or Meetings

(Choose either Option 1 or Option 2)

(Option 1 – Use Paragraphs A & B below for standard AGREEMENT)

- A. CONTRACTOR shall submit progress reports at least once a month. The report should be sufficiently detailed for the COUNTY's Contract Administrator to determine, if CONTRACTOR is performing to expectations, or is on schedule; to provide communication of interim findings, and to sufficiently address any difficulties or special problems encountered, so remedies can be developed.
- B. CONTRACTOR's Project Manager shall meet with COUNTY's Contract Administrator, as needed, to discuss progress on the contract.

(Option 2 – Use Paragraphs A & B below for ON-CALL AGREEMENTS)

- A. CONTRACTOR shall submit progress reports on each specific project in accordance with the Task Order. These reports shall be submitted at least once a month. The report should be sufficiently detailed for COUNTY's Contract Administrator or Project Coordinator to determine, if CONTRACTOR is performing to expectations, or is on schedule; to provide communication of interim findings, and to sufficiently address any difficulties or special problems encountered, so remedies can be developed.
- B. CONTRACTOR's Project Manager shall meet with COUNTY's Contract Administrator or Project Coordinator, as needed, to discuss progress on the project(s).

Appendix III
EXHIBIT B – FEDERAL PROVISIONS
CALTRANS LOCAL ASSISTANCE PROCEDURES MANUAL

Article III Statement of Work

(Insert Appropriate Statement of work including a Description of the Deliverables) *in the following sections. If a section does not apply to the AGREEMENT, state "Not Applicable to this AGREEMENT."*)

A. CONTRACTOR Services

Detail based on the services to be furnished should be provided by CONTRACTOR. Nature and extent should be verified in the negotiations to make precise statements to eliminate subsequent uncertainties and misunderstandings. Reference to the appropriate standards for design or other standards for work performance stipulated in CONTRACTOR AGREEMENT should be included. Describe acceptance criteria, and if the responsible CONTRACTOR /engineer shall sign all Plans, Specifications and Estimate (PS&E) and engineering data furnished under the AGREEMENT including registration number.

Environmental documents are not considered complete until a Caltrans District Senior Environmental Planner signs the Categorical Exclusion, a Caltrans Deputy District Director signs the Finding of No Significant Impact, or the Caltrans District Director signs the Record of Decision (see LAPM Chapter 6: Environmental Procedures, and the Standard Environmental Reference).

B. Right of Way

State whether Right of Way requirements to be determined and shown by CONTRACTOR, whether land surveys and computations with metes and bounds descriptions are to be made, and whether Right of Way parcel maps are to be furnished.

C. Surveys

State whether or not the CONTRACTOR has the responsibility for performing preliminary or construction surveys.

D. Subsurface Investigations

State specifically whether or not CONTRACTOR has the responsibility for making subsurface investigations. If borings or other specialized services are to be made by others under the supervision of CONTRACTOR, appropriate provisions are to be incorporated. Archaeological testing and data recovery guidance can be found in the Standard Environmental Reference.

E. COUNTY (LOCAL AGENCY) Obligations

All data applicable to the project and in possession of COUNTY (local agency), another agency, or government agency that are to be made available to CONTRACTOR are referred to in the AGREEMENT. Any other assistance or services to be furnished to CONTRACTOR are to be stated clearly.

F. Conferences, Site Visits, Inspection of Work

This AGREEMENT provides for conferences as needed, visits to the site, and inspection of the work by representatives of the COUNTY, State, and/or FHWA. Costs incurred by CONTRACTOR for meetings, subsequent to the initial meeting shall be included in the fee.

G. Checking Shop Drawings

For AGREEMENTS requiring the preparation of construction drawings, and make provision for checking shop drawings. Payment for checking shop drawings by CONTRACTOR is included in the Contract AGREEMENT fee, or provision may be made for separate payment. .

Appendix III
EXHIBIT B – FEDERAL PROVISIONS
CALTRANS LOCAL ASSISTANCE PROCEDURES MANUAL

H. CONTRACTOR Services During Construction

The extent, if any of CONTRACTOR's services during the course of construction as material testing, construction surveys, etc., are specified in the AGREEMENT together with the method of payment for such services.

I. Documentation and Schedules

AGREEMENTs where appropriate, shall provide that CONTRACTOR document the results of the work to the satisfaction of COUNTY, and if applicable, the State and FHWA. This may include preparation of progress and final reports, plans, specifications and estimates, or similar evidence of attainment of the AGREEMENT objectives.

J. Deliverables and Number of Copies

The number of copies or documents to be furnished such as reports, brochures, sets of plans, specifications, or Right of Way parcel maps *shall be specified*. Provision may be made for payment for additional copies.

Article IV Performance Period

A time must be set for beginning and ending the work under the AGREEMENT. The time allowed for performing the work is specified; it should be reasonable for the kind and amount of services contemplated; and it is written into the AGREEMENT. If it is desirable that Critical Path Method (CPM) networks, or other types of schedules be prepared by CONTRACTOR, they should be identified and incorporated into the AGREEMENT.

- A. This AGREEMENT shall go into effect on (_____), contingent upon approval by COUNTY, and CONTRACTOR shall commence work after notification to proceed by COUNTY Contract Administrator. The AGREEMENT shall end on (_____), unless extended by AGREEMENT amendment.
- B. CONTRACTOR is advised that any recommendation for AGREEMENT award is not binding on COUNTY until the AGREEMENT is fully executed and approved by COUNTY.

Use paragraph C below in addition to paragraphs A & B above. for on-call AGREEMENTs. On-call AGREEMENTs shall be 5 years maximum.

- C. The period of performance for each specific project shall be in accordance with the Task Order for that project. If work on a Task Order is in progress on the expiration date of this AGREEMENT, the terms of the AGREEMENT shall be extended by AGREEMENT amendment prior to the expiration of the AGREEMENT to cover the time needed to complete the task order in progress only. The maximum term shall not exceed five (5) years.

Appendix III
EXHIBIT B – FEDERAL PROVISIONS
CALTRANS LOCAL ASSISTANCE PROCEDURES MANUAL

Article V Allowable Costs and Payments

(Choose either Option 1, 2, 3, or 4)

(Option 1 - Use paragraphs A through K below for Cost-Plus-Fixed Fee AGREEMENTs. Use [Exhibit10-H1: Cost Proposal Format](#))

- A. The method of payment for this AGREEMENT will be based on actual cost plus a fixed fee. COUNTY will reimburse CONTRACTOR for actual costs (including labor costs, employee benefits, travel, equipment rental costs, overhead and other direct costs) incurred by CONTRACTOR in performance of the work. CONTRACTOR will not be reimbursed for actual costs that exceed the estimated wage rates, employee benefits, travel, equipment rental, overhead, and other estimated costs set forth in the approved CONTRACTOR'S Cost Proposal, unless additional reimbursement is provided for by AGREEMENT amendment. In no event, will CONTRACTOR be reimbursed for overhead costs at a rate that exceeds COUNTY's approved overhead rate set forth in the Cost Proposal. In the event, that COUNTY determines that a change to the work from that specified in the Cost Proposal and AGREEMENT is required, the AGREEMENT time or actual costs reimbursable by COUNTY shall be adjusted by AGREEMENT amendment to accommodate the changed work. The maximum total cost as specified in Paragraph "I" of this Article shall not be exceeded, unless authorized by AGREEMENT amendment.
- B. The indirect cost rate established for this AGREEMENT is extended through the duration of this specific AGREEMENT. CONTRACTOR's agreement to the extension of the 1-year applicable period shall not be a condition or qualification to be considered for the work or AGREEMENT award.
- C. In addition to the allowable incurred costs, COUNTY will pay CONTRACTOR a fixed fee of \$ _____. The fixed fee is nonadjustable for the term of the AGREEMENT, except in the event of a significant change in the scope of work and such adjustment is made by AGREEMENT amendment.
- D. Reimbursement for transportation and subsistence costs shall not exceed the rates specified in the approved Cost Proposal.
- E. When milestone cost estimates are included in the approved Cost Proposal, CONTRACTOR shall obtain prior written approval for a revised milestone cost estimate from the Contract Administrator before exceeding such cost estimate.
- F. Progress payments will be made monthly in arrears based on services provided and allowable incurred costs. A pro rata portion of CONTRACTOR's fixed fee will be included in the monthly progress payments. If CONTRACTOR fails to submit the required deliverable items according to the schedule set forth in Article III Statement of Work, COUNTY shall have the right to delay payment or terminate this AGREEMENT.
- G. No payment will be made prior to approval of any work, nor for any work performed prior to approval of this AGREEMENT.
- H. CONTRACTOR will be reimbursed, promptly according to California Regulations upon receipt by COUNTY's Contract Administrator of itemized invoices in duplicate. Invoices shall be submitted no

Appendix III
EXHIBIT B – FEDERAL PROVISIONS
CALTRANS LOCAL ASSISTANCE PROCEDURES MANUAL

later than thirty (30) calendar days after the performance of work for which CONTRACTOR is billing. Invoices shall detail the work performed on each milestone and each project as applicable. Invoices shall follow the format stipulated for the approved Cost Proposal and shall reference this AGREEMENT number and project title. Final invoice must contain the final cost and all credits due COUNTY including any equipment purchased under the provisions of Article XI Equipment Purchase. The final invoice should be submitted within sixty (60) calendar days after completion of CONTRACTOR's work. Invoices shall be mailed to COUNTY's Contract Administrator at the following address:

County of Monterey
Department of Public Works, Facilities, & Parks
1441 Schilling Place, South 2nd Floor
Salinas, CA 93901-4527
Attn: Finance Division

- I. The total amount payable by COUNTY including the fixed fee shall not exceed \$_____.
- J. For personnel subject to prevailing wage rates as described in the California Labor Code, all salary increases, which are the direct result of changes in the prevailing wage rates are reimbursable.

(Option 2 - For Cost per Unit of Work AGREEMENTs, replace paragraphs A & B of Option 1 with the following paragraphs A, B, and C and re-letter the remaining paragraphs. Adjust as necessary for workspecific to your project. Use [Exhibit 10-H3: Cost Proposal Format](#)).

- A. The method of payment for the following items shall be at the rate specified for each item, as described in this Article. The specified rate shall include full compensation to CONTRACTOR for the item as described, including but not limited to, any repairs, maintenance, or insurance, and no further compensation will be allowed, therefore.

The specified rate to be paid for vehicle expense for CONTRACTOR's field personnel shall be \$_____ per approved Cost Proposal. This rate shall be for a fully equipped vehicle(s) specified in Article III Statement of Work, as applicable the specified rate to be paid for equipment shall be, as listed in the approved Cost Proposal.

- B. The method of payment for this AGREEMENT, except those items to be paid for on a specified rate basis, will be based on cost per unit of work. COUNTY will reimburse CONTRACTOR for actual costs (including labor costs, employee benefits, travel, equipment-rental costs, overhead and other direct costs) incurred by CONTRACTOR in performance of the work. CONTRACTOR will not be reimbursed for actual costs that exceed the estimated wage rates, employee benefits, travel, equipment rental, overhead and other estimated costs set forth in the approved Cost Proposal, unless additional reimbursement is provided for, by AGREEMENT amendment. In no event, will CONTRACTOR be reimbursed for overhead costs at a rate that exceeds COUNTY approved overhead rate set forth in the approved Cost Proposal. In the event, COUNTY determines that changed work from that specified in the approved Cost Proposal and AGREEMENT is required; the actual costs reimbursable by COUNTY may be adjusted by AGREEMENT amendment to accommodate the changed work. The maximum total cost as specified in Paragraph "I," of this article shall not be exceeded unless authorized by AGREEMENT amendment.

Appendix III
EXHIBIT B – FEDERAL PROVISIONS
CALTRANS LOCAL ASSISTANCE PROCEDURES MANUAL

(Option 3 - Use paragraphs A through P for Specific Rates of Compensation Agreements [such as on-call Agreements]). This payment method shall only be used when it is not possible at the time of procurement to estimate the extent or duration of the work or to estimate costs with any reasonable degree of accuracy. The specific rates of compensation payment method should be limited to AGREEMENTs or components of AGREEMENTs for specialized or support type services where the CONTRACTOR is not in direct control of the number of hours worked, such as construction engineering and inspection. Use [Exhibit 10-H2: Cost Proposal Format](#).

- A. CONTRACTOR will be reimbursed for hours worked at the hourly rates specified in CONTRACTORs approved Cost Proposal. The specified hourly rates shall include direct salary costs, employee benefits, prevailing wages, employer payments, overhead, and fee. These rates are not adjustable for the performance period set forth in this AGREEMENT. Contractor will be reimbursed within thirty (30) calendar days upon receipt by COUNTY's Contract Administrator of itemized invoices in duplicate.
- B. In addition, CONTRACTOR will be reimbursed for incurred (actual) direct costs other than salary costs that are in the approved Cost Proposal and identified in the approved cost proposal and in the executed Task Order.
- C. Specific projects will be assigned to CONTRACTOR through issuance of TaskOrders.
- D. After a project to be performed under this AGREEMENT is identified by COUNTY, COUNTY will prepare a draft Task Order; less the cost estimate. A draft Task Order will identify the scope of services, expected results, project deliverables, period of performance, project schedule and will designate a COUNTY Project Coordinator. The draft Task Order will be delivered to CONTRACTOR for review. CONTRACTOR shall return the draft Task Order within ten (10) calendar days along with a Cost Estimate, including a written estimate of the number of hours and hourly rates per staff person, any anticipated reimbursable expenses, overhead, fee if any, and total dollar amount. After agreement has been reached on the negotiable items and total cost; the finalized Task Order shall be signed by both COUNTY and CONTRACTOR.
- E. Task Orders may be negotiated for a lump sum (Firm Fixed Price) or for specific rates of compensation, both of which must be based on the labor and other rates set forth in CONTRACTOR's approved Cost Proposal.

CONTRACTOR shall be responsible for any future adjustments to prevailing wage rates including but not limited to, base hourly rates and employer payments as determined by the Department of Industrial Relations. CONTRACTOR is responsible for paying the appropriate rate, including escalations that take place during the term of the AGREEMENT.

- F. *(County to include either (a) or (b) below; delete the other one)*
 - (a) Reimbursement for transportation and subsistence costs shall not exceed State rates.
 - (b) Reimbursement for transportation and subsistence costs shall not exceed the rates as specified in the approved Cost Proposal. CONTRACTOR will be responsible for transportation and subsistence costs in excess of State rates.

Appendix III
EXHIBIT B – FEDERAL PROVISIONS
CALTRANS LOCAL ASSISTANCE PROCEDURES MANUAL

- G. When milestone cost estimates are included in the approved Cost Proposal, CONTRACTOR shall obtain prior written approval in the form of a AGREEMENT amendment for a revised milestone cost estimate from the Contract Administrator before exceeding such estimate.
- H. Progress payments for each Task Order will be made monthly in arrears based on services provided and actual costs incurred.
- I. CONTRACTOR shall not commence performance of work or services until this AGREEMENT has been approved by COUNTY, and notification to proceed has been issued by COUNTY'S Contract Administrator. No payment will be made prior to approval or for any work performed prior to approval of this AGREEMENT.
- J. A Task Order is of no force or effect until returned to COUNTY and signed by an authorized representative of COUNTY. No expenditures are authorized on a project and work shall not commence until a Task Order for that project has been executed by COUNTY.
- K. CONTRACTOR will be reimbursed, within thirty (30) days upon receipt by COUNTY'S Contract Administrator of itemized invoices in duplicate. Separate invoices itemizing all costs are required for all work performed under each Task Order. Invoices shall be submitted no later than thirty (30) calendar days after the performance of work for which CONTRACTOR is billing, or upon completion of the Task Order. Invoices shall detail the work performed on each milestone, on each project as applicable. Invoices shall follow the format stipulated for the approved Cost Proposal and shall reference this AGREEMENT number, project title and Task Order number. Credits due COUNTY that include any equipment purchased under the provisions of Article XI Equipment Purchase, must be reimbursed by CONTRACTOR prior to the expiration or termination of this AGREEMENT. Invoices shall be mailed to COUNTY's Contract Administrator at the following address:

County of Monterey
Department of Public Works, Facilities, & Parks
1441 Schilling Place, South 2nd Floor
Salinas, CA 93901-4527
Attn: Finance Division
- L. The period of performance for Task Orders shall be in accordance with dates specified in the Task Order. No Task Order will be written which extends beyond the expiration date of this AGREEMENT.
- M. The total amount payable by COUNTY for an individual Task Order shall not exceed the amount agreed to in the Task Order, unless authorized by amendment.
- N. If Contractor fails to satisfactorily complete a deliverable according to the schedule set forth in a Task Order, no payment will be made until the deliverable has been satisfactorily completed.
- O. Task Orders may not be used to amend the language (or terms) of this AGREEMENT nor to exceed the scope of work under this AGREEMENT.
- P. The total amount payable by COUNTY for all Task Orders resulting from this AGREEMENT shall not

Appendix III
EXHIBIT B – FEDERAL PROVISIONS
CALTRANS LOCAL ASSISTANCE PROCEDURES MANUAL

exceed \$ _____. It is understood and agreed that there is no guarantee, either expressed or implied that this dollar amount will be authorized under this AGREEMENT through Task Orders.

(Option 4 - Use paragraphs A through E below for lump sum agreements. Use [Exhibit 10-H1: CostProposal Format](#))

- A. The method of payment for this AGREEMENT will be based on lump sum. The total lump sum price paid to CONTRACTOR will include compensation for all work and deliverables, including travel and equipment described in Article III Statement of Work. No additional compensation will be paid to CONTRACTOR, unless there is a change in the scope of the work or the scope of the project. In the instance of a change in the scope of work or scope of the project, adjustment to the total lump sum compensation will be negotiated between CONTRACTOR and COUNTY. Adjustment in the total lump sum compensation will not be effective until authorized by contract amendment and approved by COUNTY.
- B. Progress payments may be made monthly in arrears based on the percentage of work completed by CONTRACTOR. If CONTRACTOR fails to submit the required deliverable items according to the schedule set forth in Article III Statement of Work, COUNTY shall have the right to delay payment or terminate this AGREEMENT in accordance with the provisions of Article VI Termination.
- C. CONTRACTOR shall not commence performance of work or services until this AGREEMENT has been approved by COUNTY and notification to proceed has been issued by COUNTY'S Contract Administrator. No payment will be made prior to approval of any work, or for any work performed prior to approval of this AGREEMENT.
- D. CONTRACTOR will be reimbursed within thirty (30) days upon receipt by County's Contract Administrator of itemized invoices in duplicate. Invoices shall be submitted no later than thirty (30) calendar days after the performance of work for which CONTRACTOR is billing. Invoices shall detail the work performed on each milestone, on each project as applicable. Invoices shall follow the format stipulated for the approved Cost Proposal and shall reference this AGREEMENT number and project title. Final invoice must contain the final cost and all credits due COUNTY that include any equipment purchased under the provisions of Article XI Equipment Purchase. The final invoice must be submitted within sixty (60) calendar days after completion of CONTRACTOR's work unless a later date is approved by County. Invoices shall be mailed to COUNTY's Contract Administrator at the following address:

County of Monterey
Department of Public Works, Facilities, & Parks
1441 Schilling Place, South 2nd Floor
Salinas, CA 93901-4527
Attn: Finance Division

- E. The total amount payable by COUNTY shall not exceed \$_____.

Article VI Termination

Appendix III
EXHIBIT B – FEDERAL PROVISIONS
CALTRANS LOCAL ASSISTANCE PROCEDURES MANUAL

- A. This AGREEMENT may be terminated by COUNTY, provided that COUNTY gives not less than thirty (30) calendar days' written notice (delivered by certified mail, return receipt requested) of intent to terminate. Upon termination, COUNTY shall be entitled to all work, including but not limited to, reports, investigations, appraisals, inventories, studies, analyses, drawings and data estimates performed to that date, whether completed or not.
- B. COUNTY may temporarily suspend this AGREEMENT, at no additional cost to COUNTY, provided that CONTRACTOR is given written notice (delivered by certified mail, return receipt requested) of temporary suspension. If COUNTY gives such notice of temporary suspension, CONTRACTOR shall immediately suspend its activities under this AGREEMENT. A temporary suspension may be issued concurrent with the notice of termination.
- C. Notwithstanding any provisions of this AGREEMENT, CONTRACTOR shall not be relieved of liability to COUNTY for damages sustained by COUNTY by virtue of any breach of this AGREEMENT by CONTRACTOR, and COUNTY may withhold any payments due to CONTRACTOR until such time as exact amount of damages, if any, due COUNTY from CONTRACTOR is determined.
- D. In the event of termination, CONTRACTOR shall be compensated as provided for in this AGREEMENT. Upon termination, COUNTY shall be entitled to all work, including but not limited to, reports, investigations, appraisals, inventories, studies, analyses, drawings and data estimates performed to that date, whether completed or not.

Article VII Cost Principles and Administrative Requirements

- A. CONTRACTOR agrees that 48 CFR Part 31, Contract Cost Principles and Procedures shall be used to determine the allowability of individual terms of cost.
- B. CONTRACTOR also agrees to comply with Federal procedures in accordance with 2 CFR, Part 200, Uniform Administrative Requirements, Cost Principles, and Audit Requirements for Federal Awards.
- C. Any costs for which payment has been made to CONTRACTOR that are determined by subsequent audit to be unallowable under 48 CFR Part 31 or 2 CFR Part 200 are subject to repayment by CONTRACTOR to COUNTY.

When a CONTRACTOR or subcontractor is a Non-Profit Organization or an Institution of Higher Education, the Cost Principles for Title 2 CFR Part 200, Uniform Administrative Requirements, Cost Principles, and Audit Requirements for Federal Awards shall apply.

Appendix III
EXHIBIT B – FEDERAL PROVISIONS
CALTRANS LOCAL ASSISTANCE PROCEDURES MANUAL

Article VIII Retention of Records/Audit

For the purpose of determining compliance with Government Code §8546.7, the CONTRACTOR, subcontractors, and COUNTY shall maintain all books, documents, papers, accounting records, Independent CPA Audited Indirect Cost Rate workpapers, and other evidence pertaining to the performance of the AGREEMENT, including but not limited to, the costs of administering the AGREEMENT. All parties, including the CONTRACTOR's Independent CPA, shall make such workpapers and materials available at their respective offices at all reasonable times during the AGREEMENT period and for three (3) years from the date of final payment under the AGREEMENT. COUNTY, Caltrans Auditor, FHWA, or any duly authorized representative of the Federal Government having jurisdiction under Federal laws or regulations (including the basis of Federal funding in whole or in part) shall have access to any books, records, and documents of CONTRACTOR, subcontractor and the CONTRACTOR's Independent CPA, that are pertinent to the AGREEMENT for audits, examinations, workpaper review, excerpts, and transactions, and copies thereof shall be furnished if requested without limitation.

Article IX Audit Review Procedures

- A. Any dispute concerning a question of fact arising under an interim or post audit of this AGREEMENT that is not disposed of by AGREEMENT, shall be reviewed by COUNTY'S Chief Financial Officer.
- B. Not later than thirty (30) calendar days after issuance of the final audit report, CONTRACTOR may request a review by COUNTY'S Chief Financial Officer of unresolved audit issues. The request for review will be submitted in writing.
- C. Neither the pendency of a dispute nor its consideration by COUNTY will excuse CONTRACTOR from full and timely performance, in accordance with the terms of this AGREEMENT.
- D. CONTRACTOR and subcontractor AGREEMENTS, including cost proposals and Indirect Cost Rates (ICR), may be subject to audits or reviews such as, but not limited to, an AGREEMENT audit, an incurred cost audit, an ICR Audit, or a CPA ICR audit work paper review. If selected for audit or review, the AGREEMENT, cost proposal and ICR and related work papers, if applicable, will be reviewed to verify compliance with 48 CFR, Part 31 and other related laws and regulations. In the instances of a CPA ICR audit work paper review, it is CONTRACTOR's responsibility to ensure federal, state, COUNTY or local government officials are allowed full access to the CPA's work papers including making copies as necessary. The AGREEMENT, cost proposal, and ICR shall be adjusted by CONTRACTOR and approved by COUNTY Contract Administrator to conform to the audit or review recommendations. CONTRACTOR agrees that individual terms of costs identified in the audit report shall be incorporated into the AGREEMENT by this reference if directed by COUNTY at its sole discretion. Refusal by CONTRACTOR to incorporate audit or review recommendations, or to ensure that the federal, COUNTY or local governments have access to CPA work papers, will be considered a breach of AGREEMENT terms and cause for termination of the AGREEMENT and disallowance of prior reimbursed costs.
- E. CONTRACTOR's Cost Proposal may be subject to a CPA ICR Audit Work Paper Review and/or audit

Appendix III
EXHIBIT B – FEDERAL PROVISIONS
CALTRANS LOCAL ASSISTANCE PROCEDURES MANUAL

by the Independent Office of Audits and Investigations (IOAI). IOAI, at its sole discretion, may review and/or audit and approve the CPA ICR documentation. The Cost Proposal shall be adjusted by the CONTRACTOR and approved by the COUNTY Contract Administrator to conform to the Work Paper Review recommendations included in the management letter or audit recommendations included in the audit report. Refusal by the CONTRACTOR to incorporate the Work Paper Review recommendations included in the management letter or audit recommendations included in the audit report will be considered a breach of the AGREEMENT terms and cause for termination of the AGREEMENT and disallowance of prior reimbursed costs.

1. During IOAI's review of the ICR audit work papers created by the CONTRACTOR's independent CPA, IOAI will work with the CPA and/or CONTRACTOR toward a resolution of issues that arise during the review. Each party agrees to use its best efforts to resolve any audit disputes in a timely manner. If IOAI identifies significant issues during the review and is unable to issue a cognizant approval letter, COUNTY will reimburse the CONTRACTOR at an accepted ICR until a FAR (Federal Acquisition Regulation) compliant ICR {e.g. 48 CFR, Part 31; GAGAS (Generally Accepted Government Auditing Standards); CAS (Cost Accounting Standards), if applicable; in accordance with procedures and guidelines of the American Association of State Highways and Transportation Officials (AASHTO) Audit Guide; and other applicable procedures and guidelines} is received and approved by IOAI.

Accepted rates will be as follows:

- a. If the proposed rate is less than one hundred fifty percent (150%) - the accepted rate reimbursed will be ninety percent (90%) of the proposed rate.
 - b. If the proposed rate is between one hundred fifty percent (150%) and two hundred percent (200%) - the accepted rate will be eighty-five percent (85%) of the proposed rate.
 - c. If the proposed rate is greater than two hundred percent (200%) - the accepted rate will be seventy-five percent (75%) of the proposed rate.
2. If IOAI is unable to issue a cognizant letter per paragraph E.1. above, IOAI may require CONTRACTOR to submit a revised independent CPA-audited ICR and audit report within three (3) months of the effective date of the management letter. IOAI will then have up to six (6) months to review the CONTRACTOR's and/or the independent CPA's revisions.
 3. If the CONTRACTOR fails to comply with the provisions of this paragraph E, or if IOAI is still unable to issue a cognizant approval letter after the revised independent CPA-audited ICR is submitted, overhead cost reimbursement will be limited to the accepted ICR that was established upon initial rejection of the ICR and set forth in paragraph E.1. above for all rendered services. In this event, this accepted ICR will become the actual and final ICR for reimbursement purposes under this AGREEMENT.
 4. CONTRACTOR may submit to COUNTY final invoice only when all of the following items have occurred: (1) IOAI accepts or adjusts the original or revised independent CPA-audited ICR; (2)

Appendix III
EXHIBIT B – FEDERAL PROVISIONS
CALTRANS LOCAL ASSISTANCE PROCEDURES MANUAL

all work under this AGREEMENT has been completed to the satisfaction of COUNTY; and,
(3) IOAI has issued its final ICR review letter. The CONTRACTOR MUST SUBMIT ITS FINAL INVOICE TO County no later than sixty (60) calendar days after occurrence of the last of these items.

The accepted ICR will apply to this AGREEMENT and all other agreements executed between COUNTY and the CONTRACTOR, either as a prime or subcontractor, with the same fiscal period ICR.

Article X Subcontracting

- A. Nothing contained in this AGREEMENT or otherwise, shall create any contractual relation between the COUNTY and any subcontractor(s), and no subagreement shall relieve the CONTRACTOR of its responsibilities and obligations hereunder. The CONTRACTOR agrees to be as fully responsible to the COUNTY for the acts and omissions of its subcontractor(s) and of persons either directly or indirectly employed by any of them as it is for the acts and omissions of persons directly employed by the CONTRACTOR. The CONTRACTOR's obligation to pay its subcontractor(s) is an independent obligation from the COUNTY'S obligation to make payments to the CONTRACTOR.
- B. CONTRACTOR shall perform the work contemplated with resources available within its own organization and no portion of the work shall be subcontracted without written authorization by COUNTY's Contract Administrator, except that, which is expressly identified in the CONTRACTOR's approved Cost Proposal.
- C. Any subagreement entered into as a result of this AGREEMENT shall contain all the provisions stipulated in this entire AGREEMENT to be applicable to subcontractors unless otherwise noted.
- D. CONTRACTOR shall pay its subcontractors within Fifteen (15) calendar days from receipt of each payment made to the CONTRACTOR by the COUNTY.
- E. Any substitution of subcontractor(s) must be approved in writing by COUNTY's Contract Administrator in advance of assigning work to a substitute subcontractor(s).

F. Prompt Progress Payment

CONTRACTOR or subcontractor shall pay to any subcontractor, not later than fifteen (15) days after receipt of each progress payment, unless otherwise agreed to in writing, the respective amounts allowed CONTRACTOR on account of the work performed by the subcontractors, to the extent of each subcontractor's interest therein. In the event that there is a good faith dispute over all or any portion of the amount due on a progress payment from CONTRACTOR or subcontractor to a subcontractor, CONTRACTOR or subcontractor may withhold no more than 150 percent of the disputed amount. Any violation of this requirement shall constitute a cause for disciplinary action and shall subject the licensee to a penalty, payable to the subcontractor, of 2 percent of the amount due per month for every month that payment is not made.

In any action for the collection of funds wrongfully withheld, the prevailing party shall be entitled to his or her attorney's fees and costs. The sanctions authorized under this requirement shall be separate from, and in addition to, all other remedies, either civil, administrative, or criminal. This clause applies to both DBE and non-DBE subcontractors.

Appendix III
EXHIBIT B – FEDERAL PROVISIONS
CALTRANS LOCAL ASSISTANCE PROCEDURES MANUAL

G. Prompt Payment of Withheld Funds to subcontractors

The COUNTY may hold retainage from CONTRACTOR and shall make prompt and regular incremental acceptances of portions, as determined by the COUNTY, of the contract work, and pay retainage to CONTRACTOR based on these acceptances. The COUNTY shall designate one of the methods below in the contract to ensure prompt and full payment of any retainage kept by CONTRACTOR or subcontractor to a subcontractor. (Choose either Method 1, Method 2, or Method 3 below and delete the other two.)

Method 1: No retainage will be held by the COUNTY from progress payments due to CONTRACTOR. CONTRACTORS and subcontractors are prohibited from holding retainage from subcontractors. Any delay or postponement of payment may take place only for good cause and with the COUNTY's prior written approval. Any violation of these provisions shall subject the violating CONTRACTOR or subcontractor to the penalties, sanctions, and other remedies specified in Section 3321 of the California Civil Code. This requirement shall not be construed to limit or impair any contractual, administrative or judicial remedies, otherwise available to CONTRACTOR or subcontractor in the event of a dispute involving late payment or nonpayment by CONTRACTOR, deficient subcontractor performance and/or noncompliance by a subcontractor. This clause applies to both DBE and non-DBE subcontractors.

Method 2: No retainage will be held by the COUNTY from progress payments due to CONTRACTOR. Any retainage kept by CONTRACTOR or by a subcontractor must be paid in full to the earning subcontractor within 15 days after the subcontractor's work is satisfactorily completed. Any delay or postponement of payment may take place only for good cause and with the COUNTY's prior written approval. Any violation of these provisions shall subject the violating CONTRACTOR or subcontractor to the penalties, sanctions, and remedies specified in Section 3321 of the California Civil Code. This requirement shall not be construed to limit or impair any contractual, administrative or judicial remedies, otherwise available to CONTRACTOR or subcontractor in the event of a dispute involving late payment or nonpayment by CONTRACTOR, deficient subcontractor performance and/or noncompliance by a subcontractor. This clause applies to both DBE and non-DBE subcontractors.

Method 3: The COUNTY shall hold retainage from CONTRACTOR and shall make prompt and regular incremental acceptances of portions, as determined by the COUNTY of the contract work and pay retainage to CONTRACTOR based on these acceptances. CONTRACTOR or subcontractor shall return all monies withheld in retention from all subcontractors within 15 days after receiving payment for work satisfactorily completed and accepted including incremental acceptances of portions of the contract work by the COUNTY. Any delay or postponement of payment may take place only for good cause and with the COUNTY's prior written approval. Any violation of these provisions shall subject the violating CONTRACTOR or subcontractor to the penalties, sanctions, and other remedies specified in Section 3321 of the California Civil Code. This requirement shall not be construed to limit or impair any contractual, administrative or judicial remedies otherwise available to CONTRACTOR or subcontractor in the event of a dispute involving late payment or nonpayment by CONTRACTOR; deficient subcontractor performance and/or noncompliance by a subcontractor. This clause applies to both DBE and non-DBE subcontractors.

Any violation of these provisions shall subject the violating CONTRACTOR or subcontractor to the penalties, sanctions and other remedies specified therein. These requirements shall not be construed to limit or impair any contractual, administrative, or judicial remedies otherwise available to CONTRACTOR or subcontractor in the event of a dispute involving late payment or nonpayment by CONTRACTOR, deficient subcontract performance, or noncompliance by a subcontractor.

Appendix III
EXHIBIT B – FEDERAL PROVISIONS
CALTRANS LOCAL ASSISTANCE PROCEDURES MANUAL

Article XI Equipment Purchase and Other Capital Expenditures

- A. Prior authorization in writing, by COUNTY's Contract Administrator shall be required before CONTRACTOR enters into any unbudgeted purchase order, or subcontract exceeding five thousand dollars (\$5,000) for supplies, equipment, or CONTRACTOR services. CONTRACTOR shall provide an evaluation of the necessity or desirability of incurring such costs.
- B. For purchase of any item, service or consulting work not covered in CONTRACTOR's approved Cost Proposal and exceeding five thousand dollars (\$5,000) with prior authorization by COUNTY's Contract Administrator; three competitive quotations must be submitted with the request, or the absence of proposal must be adequately justified.
- C. Any equipment purchased with funds provided under the terms of this AGREEMENT is subject to the following:
 - 1. CONTRACTOR shall maintain an inventory of all nonexpendable property. Nonexpendable property is defined as having a useful life of at least two years and an acquisition cost of five thousand dollars (\$5,000) or more. If the purchased equipment needs replacement and is sold or traded in, COUNTY shall receive a proper refund or credit at the conclusion of the AGREEMENT, or if the AGREEMENT is terminated, CONTRACTOR may either keep the equipment and credit COUNTY in an amount equal to its fair market value, or sell such equipment at the best price obtainable at a public or private sale, in accordance with established COUNTY procedures; and credit COUNTY in an amount equal to the sales price. If CONTRACTOR elects to keep the equipment, fair market value shall be determined at CONTRACTOR's expense, on the basis of a competent independent appraisal of such equipment. Appraisals shall be obtained from an appraiser mutually agreeable to by COUNTY and CONTRACTOR, if it is determined to sell the equipment, the terms and conditions of such sale must be approved in advance by COUNTY.
 - 2. Regulation 2 CFR Part 200 requires a credit to Federal funds when participating equipment with a fair market value greater than five thousand dollars (\$5,000) is credited to the project.

Article XII State Prevailing Wage Rates

- A. No CONTRACTOR or Subcontractor may be awarded an AGREEMENT containing public work elements unless registered with the Department of Industrial Relations (DIR) pursuant to Labor Code §1725.5. Registration with DIR must be maintained throughout the entire term of this AGREEMENT, including any subsequent amendments.
- B. The CONTRACTOR shall comply with all of the applicable provisions of the California Labor Code requiring the payment of prevailing wages. The General Prevailing Wage Rate Determinations applicable to work under this AGREEMENT are available and on file with the Department of Transportation's Regional/District Labor Compliance Officer(<https://dot.ca.gov/programs/construction/labor-compliance>). These wage rates are made a specific part of this AGREEMENT by reference pursuant to Labor Code §1773.2 and will

Appendix III
EXHIBIT B – FEDERAL PROVISIONS
CALTRANS LOCAL ASSISTANCE PROCEDURES MANUAL

be applicable to work performed at a construction project site. Prevailing wages will be applicable to all inspection work performed at COUNTY construction sites, at COUNTY facilities and at off-site locations that are set up by the construction contractor or one of its subcontractors solely and specifically to serve COUNTY projects. Prevailing wage requirements do not apply to inspection work performed at the facilities of vendors and commercial materials suppliers that provide goods and services to the general public.

C. General Prevailing Wage Rate Determinations applicable to this project may also be obtained from the Department of Industrial Relations website at <http://www.dir.ca.gov>.

D. Payroll Records

1. Each CONTRACTOR and Subcontractor shall keep accurate certified payroll records and supporting documents as mandated by Labor Code §1776 and as defined in 8 CCR §16000 showing the name, address, social security number, work classification, straight time and overtime hours worked each day and week, and the actual per diem wages paid to each journeyman, apprentice, worker, or other employee employed by the CONTRACTOR or Subcontractor in connection with the public work. Each payroll record shall contain or be verified by a written declaration that it is made under penalty of perjury, stating both of the following:

- a. The information contained in the payroll record is true and correct.
- b. The employer has complied with the requirements of Labor Code §1771, §1811, and §1815 for any work performed by his or her employees on the public works project.

2. The payroll records enumerated under paragraph (1) above shall be certified as correct by the CONTRACTOR under penalty of perjury. The payroll records and all supporting documents shall be made available for inspection and copying by COUNTY representatives at all reasonable hours at the principal office of the CONTRACTOR. The CONTRACTOR shall provide copies of certified payrolls or permit inspection of its records as follows:

- a. A certified copy of an employee's payroll record shall be made available for inspection or furnished to the employee or the employee's authorized representative on request.
- b. A certified copy of all payroll records enumerated in paragraph (1) above, shall be made available for inspection or furnished upon request to a representative of COUNTY, the Division of Labor Standards Enforcement and the Division of Apprenticeship Standards of the Department of Industrial Relations. Certified payrolls submitted to COUNTY, the Division of Labor Standards Enforcement and the Division of Apprenticeship Standards shall not be altered or obliterated by the CONTRACTOR.
- c. The public shall not be given access to certified payroll records by the CONTRACTOR. The CONTRACTOR is required to forward any requests for certified payrolls to the COUNTY Contract Administrator by both email and regular mail on the business day following receipt of the request.

3. Each CONTRACTOR shall submit a certified copy of the records enumerated in paragraph (1) above, to the entity that requested the records within ten (10) calendar days after receipt of a

Appendix III
EXHIBIT B – FEDERAL PROVISIONS
CALTRANS LOCAL ASSISTANCE PROCEDURES MANUAL

written request.

4. Any copy of records made available for inspection as copies and furnished upon request to the public or any public agency by COUNTY shall be marked or obliterated in such a manner as to prevent disclosure of each individual's name, address, and social security number. The name and address of the CONTRACTOR or Subcontractor performing the work shall not be marked or obliterated.

5. The CONTRACTOR shall inform COUNTY of the location of the records enumerated under paragraph (1) above, including the street address, city and county, and shall, within five (5) working days, provide a notice of a change of location and address.

6. The CONTRACTOR or Subcontractor shall have ten (10) calendar days in which to comply subsequent to receipt of written notice requesting the records enumerated in paragraph (1) above. In the event the CONTRACTOR or Subcontractor fails to comply within the ten (10) day period, he or she shall, as a penalty to COUNTY, forfeit one hundred dollars (\$100) for each calendar day, or portion thereof, for each worker, until strict compliance is effectuated. Such penalties shall be withheld by COUNTY from payments then due. CONTRACTOR is not subject to a penalty assessment pursuant to this section due to the failure of a Subcontractor to comply with this section.

E. When prevailing wage rates apply, the CONTRACTOR is responsible for verifying compliance with certified payroll requirements. Invoice payment will not be made until the invoice is approved by the COUNTY Contract Administrator.

F. Penalty

1. The CONTRACTOR and any of its Subcontractor shall comply with Labor Code §1774 and §1775. Pursuant to Labor Code §1775, the CONTRACTOR and any Subcontractor shall forfeit to the COUNTY a penalty of not more than two hundred dollars (\$200) for each calendar day, or portion thereof, for each worker paid less than the prevailing rates as determined by the Director of DIR for the work or craft in which the worker is employed for any public work done under the contract by the CONTRACTOR or by its Subcontractor in violation of the requirements of the Labor Code and in particular, Labor Code §§1770 to 1780, inclusive.

2. The amount of this forfeiture shall be determined by the Labor Commissioner and shall be based on consideration of mistake, inadvertence, or neglect of the CONTRACTOR or Subcontractor in failing to pay the correct rate of prevailing wages, or the previous record of the CONTRACTOR or Subcontractor in meeting their respective prevailing wage obligations, or the willful failure by the CONTRACTOR or Subcontractor to pay the correct rates of prevailing wages. A mistake, inadvertence, or neglect in failing to pay the correct rates of prevailing wages is not excusable if the CONTRACTOR or Subcontractor had knowledge of the obligations under the Labor Code. The CONTRACTOR is responsible for paying the appropriate rate, including any escalations that take place during the term of the AGREEMENT.

Appendix III
EXHIBIT B – FEDERAL PROVISIONS
CALTRANS LOCAL ASSISTANCE PROCEDURES MANUAL

3. In addition to the penalty and pursuant to Labor Code §1775, the difference between the prevailing wage rates and the amount paid to each worker for each calendar day or portion thereof for which each worker was paid less than the prevailing wage rate shall be paid to each worker by the CONTRACTOR or Subcontractor.

4. If a worker employed by a Subcontractor on a public works project is not paid the general prevailing per diem wages by the Subcontractor, the prime CONTRACTOR of the project is not liable for the penalties described above unless the prime CONTRACTOR had knowledge of that failure of the Subcontractor to pay the specified prevailing rate of wages to those workers or unless the prime CONTRACTOR fails to comply with all of the following requirements:

a. The AGREEMENT executed between the CONTRACTOR and the Subcontractor for the performance of work on public works projects shall include a copy of the requirements in Labor Code §§ 1771, 1775, 1776, 1777.5, 1813, and 1815.

b. The CONTRACTOR shall monitor the payment of the specified general prevailing rate of per diem wages by the Subcontractor to the employees by periodic review of the certified payroll records of the Subcontractor.

c. Upon becoming aware of the Subcontractor's failure to pay the specified prevailing rate of wages to the Subcontractor's workers, the CONTRACTOR shall diligently take corrective action to halt or rectify the failure, including but not limited to, retaining sufficient funds due the Subcontractor for work performed on the public works project.

d. Prior to making final payment to the Subcontractor for work performed on the public works project, the CONTRACTOR shall obtain an affidavit signed under penalty of perjury from the Subcontractor that the Subcontractor had paid the specified general prevailing rate of per diem wages to the Subcontractor's employees on the public works project and any amounts due pursuant to Labor Code §1813.

5. Pursuant to Labor Code §1775, COUNTY shall notify the CONTRACTOR on a public works project within fifteen (15) calendar days of receipt of a complaint that a Subcontractor has failed to pay workers the general prevailing rate of per diem wages.

6. If COUNTY determines that employees of a Subcontractor were not paid the general prevailing rate of per diem wages and if COUNTY did not retain sufficient money under the AGREEMENT to pay those employees the balance of wages owed under the general prevailing rate of per diem wages, the CONTRACTOR shall withhold an amount of moneys due the Subcontractor sufficient to pay those employees the general prevailing rate of per diem wages if requested by COUNTY.

G. Hours of Labor

Eight (8) hours labor constitutes a legal day's work. The CONTRACTOR shall forfeit, as a penalty to the COUNTY, twenty-five dollars (\$25) for each worker employed in the execution of the AGREEMENT by the CONTRACTOR or any of its Subcontractors for each calendar day during which

Appendix III
EXHIBIT B – FEDERAL PROVISIONS
CALTRANS LOCAL ASSISTANCE PROCEDURES MANUAL

such worker is required or permitted to work more than eight (8) hours in any one calendar day and forty (40) hours in any one calendar week in violation of the provisions of the Labor Code, and in particular §§1810 to 1815 thereof, inclusive, except that work performed by employees in excess of eight (8) hours per day, and forty (40) hours during any one week, shall be permitted upon compensation for all hours worked in excess of eight (8) hours per day and forty (40) hours in any week, at not less than one and one-half (1.5) times the basic rate of pay, as provided in §1815.

H. Employment of Apprentices

1. Where either the prime AGREEMENT or the subcontract exceeds thirty thousand dollars (\$30,000), the CONTRACTOR and any subcontractors under him or her shall comply with all applicable requirements of Labor Code §§ 1777.5, 1777.6 and 1777.7 in the employment of apprentices.

2. CONTRACTORS and subcontractors are required to comply with all Labor Code requirements regarding the employment of apprentices, including mandatory ratios of journey level to apprentice workers. Prior to commencement of work, CONTRACTOR and subcontractors are advised to contact the DIR Division of Apprenticeship Standards website at <https://www.dir.ca.gov/das> for additional information regarding the employment of apprentices and for the specific journey-to- apprentice ratios for the AGREEMENT work. The CONTRACTOR is responsible for all subcontractors' compliance with these requirements. Penalties are specified in Labor Code §1777.7.

Article XIII Conflict of Interest

- A. During the term of this AGREEMENT, the CONTRACTOR shall disclose any financial, business, or other relationship with COUNTY that may have an impact upon the outcome of this AGREEMENT, or any ensuing COUNTY construction project. The CONTRACTOR shall also list current clients who may have a financial interest in the outcome of this AGREEMENT, or any ensuing COUNTY construction project, which will follow.
- B. CONTRACTOR certifies that it has disclosed to COUNTY any actual, apparent, or potential conflicts of interest that may exist relative to the services to be provided pursuant to this AGREEMENT. CONTRACTOR agrees to advise COUNTY of any actual, apparent or potential conflicts of interest that may develop subsequent to the date of execution of this AGREEMENT.
- CONTRACTOR further agrees to complete any statements of economic interest if required by either COUNTY ordinance or State law.
- C. The CONTRACTOR hereby certifies that it does not now have, nor shall it acquire any financial or business interest that would conflict with the performance of services under this AGREEMENT.
- D. CONTRACTOR hereby certifies that the CONTRACTOR or subcontractor, and any firm affiliated with CONTRACTOR or subcontractor that bids on any construction contract, or on any AGREEMENT to provide construction inspection for any construction project resulting from this

Appendix III
EXHIBIT B – FEDERAL PROVISIONS
CALTRANS LOCAL ASSISTANCE PROCEDURES MANUAL

AGREEMENT. An affiliated firm is one, which is subject to the control of the same persons through joint-ownership, has established necessary controls to ensure a conflict of interest does not exist. An affiliated firm is one, which is subject to the control of the same persons, through joint ownership or otherwise.

Article XIV Rebates, Kickbacks or Other Unlawful Consideration

The CONTRACTOR warrants that this AGREEMENT was not obtained or secured through rebates kickbacks or other unlawful consideration, either promised or paid to any COUNTY employee. For breach or violation of this warranty, COUNTY shall have the right, in its discretion, to terminate this AGREEMENT without liability; to pay only for the value of the work actually performed; or to deduct from this AGREEMENT price or otherwise recover the full amount of such rebate, kickback or other unlawful consideration.

Article XV Prohibition of Expending County, State, or Federal Funds for Lobbying

(Include this article in all AGREEMENTS where federal funding will exceed \$150,000. If less than \$150,000 in federal funds will be expended on the AGREEMENT; delete this article and re-number subsequent articles.)

- A. CONTRACTOR certifies to the best of his or her knowledge and belief that:
1. No State, Federal, or County appropriated funds have been paid or will be paid, by-or-on behalf of CONTRACTOR, to any person for influencing or attempting to influence an officer or employee of any local, State or Federal agency, a Member of the State Legislature or United States Congress, an officer or employee of the Legislature or Congress, or any employee of a Member of the Legislature or Congress in connection with the awarding or making of this AGREEMENT, or with the extension, continuation, renewal, amendment, or modification of this AGREEMENT .
 2. If any funds other than Federal appropriated funds have been paid, or will be paid to any person for influencing or attempting to influence an officer or employee of any agency, a Member of Congress, an officer or employee of Congress, or an employee of a Member of Congress in connection with this AGREEMENT, the CONTRACTOR shall complete and submit Standard Form-LLL, "Disclosure Form to Report Lobbying," in accordance with its instructions.
- B. This certification is a material representation of fact upon which reliance was placed when this transaction was made or entered into. Submission of this certification is a prerequisite for making or entering into this transaction imposed by 31 U.S.C. §1352. Any person who fails to file the required certification shall be subject to a civil penalty of not less than ten thousand dollars (\$10,000) and not more than one hundred thousand dollars (\$100,000), for each such failure.
- C. The CONTRACTOR also agrees by signing this document that he or she shall require that the language of this certification be included in all lower-tier subagreements, which exceed one hundred thousand dollars (\$100,000) and that all such subrecipients shall certify and disclose accordingly.

Appendix III
EXHIBIT B – FEDERAL PROVISIONS
CALTRANS LOCAL ASSISTANCE PROCEDURES MANUAL

Article XVI Non-Discrimination Clause and Statement of Compliance

- A. The CONTRACTOR's signature affixed herein and dated shall constitute a certification under penalty of perjury under the laws of the State of California that the CONTRACTOR has, unless exempt, complied with, the nondiscrimination program requirements of Government Code § 12990 and 2 CCR §8103.
- B. During the performance of this AGREEMENT, Contractor and its subcontractors shall not deny the AGREEMENT's benefits to any person on the basis of race, religious creed, color, national origin, ancestry, physical disability, mental disability, medical condition, genetic information, marital status, sex, gender, gender identity, gender expression, age, sexual orientation, or military and veteran status, nor shall they unlawfully discriminate, harass, or allow harassment against any employee or applicant for employment because of race, religious creed, color, national origin, ancestry, physical disability, mental disability, medical condition, genetic information, marital status, sex, gender, gender identity, gender expression, age, sexual orientation, or military and veteran status. Contractor and subcontractors shall insure that the evaluation and treatment of their employees and applicants for employment are free from such discrimination and harassment.
- C. Contractor and subcontractors shall comply with the provisions of the Fair Employment and Housing Act (Gov. Code §12990 et seq.), the applicable regulations promulgated there under (2 CCR §11000 et seq.), the provisions of Gov. Code §11135-11139.5, and the regulations or standards adopted by COUNTY to implement such article. The applicable regulations of the Fair Employment and Housing Commission implementing Government Code §12990 (a-f), set forth 2 CCR §§8100-8504, are incorporated into this AGREEMENT by reference and made a part hereof as if set forth in full.
- D. CONTRACTOR shall permit access by representatives of the Department of Fair Employment and Housing and the COUNTY upon reasonable notice at any time during the normal business hours, but in no case less than twenty-four (24) hours' notice, to such of its books, records, accounts, and all other sources of information and its facilities as said Department or COUNTY shall require to ascertain compliance with this clause.
- E. Contractor and its subcontractors shall give written notice of their obligations under this clause to labor organizations with which they have a collective bargaining or other Agreement.
- F. CONTRACTOR shall include the nondiscrimination and compliance provisions of this clause in all subcontracts to perform work under this AGREEMENT.
- G. The Contractor, with regard to the work performed under this AGREEMENT, shall act in accordance with Title VI of the Civil Rights Act of 1964 (42 U.S.C. §2000d et seq.). Title VI provides that the recipients of federal assistance will implement and maintain a policy of nondiscrimination in which no person in the United States shall, on the basis of race, color, national origin, religion, sex, age, disability, be excluded from participation in, denied the benefits of or subject to discrimination under any program or activity by the recipients of federal assistance or their assignees and successors in interest.
- H. The Contractor, shall comply with regulations relative to non-discrimination in federally-assisted programs of the U.S. Department of Transportation (49 CFR Part 21 - Effectuation of Title VI of the

Appendix III
EXHIBIT B – FEDERAL PROVISIONS
CALTRANS LOCAL ASSISTANCE PROCEDURES MANUAL

Civil Rights Act of 1964). Specifically, the CONTRACTOR shall not participate either directly or indirectly in the discrimination prohibited by 49 CFR §21.5, including employment practices and the selection and retention of Subcontractors.

- I. CONTRACTOR, subrecipient or subcontractor will never exclude any person from participation in, deny any person the benefits of, or otherwise discriminate against anyone in connection with the award and performance of any contract covered by 49 CFR 26 on the basis of race, color, sex, or national origin. In administering the COUNTY components of the DBE Program Plan, CONTRACTOR, subrecipient or subcontractor will not, directly, or through contractual or other arrangements, use criteria or methods of administration that have the effect of defeating or substantially impairing accomplishment of the objectives of the DBE Program Plan with respect to individuals of a particular race, color, sex, or national origin.

Article XVII Debarment and Suspension Certification

- A. The CONTRACTOR's signature affixed herein shall constitute a certification under penalty of perjury under the laws of the State of California, that the CONTRACTOR or any person associated therewith in the capacity of owner, partner, director, officer, or manager:
 1. Is not currently under suspension, debarment, voluntary exclusion, or determination of ineligibility by any federal agency;
 2. Has not been suspended, debarred, voluntarily excluded, or determined ineligible by any federal agency within the past three (3) years;
 3. Does not have a proposed debarment pending; and
 4. Has not been indicted, convicted, or had a civil judgment rendered against it by a court of competent jurisdiction in any matter involving fraud or official misconduct within the past three (3) years.
- B. Any exceptions to this certification must be disclosed to COUNTY. Exceptions will not necessarily result in denial of recommendation for award, but will be considered in determining responsibility. Disclosures must indicate the party to whom the exceptions apply, the initiating agency, and the dates of agency action.
- C. Exceptions to the Federal Government Excluded Parties List System maintained by the U.S. General Services Administration are to be determined by FHWA.

Article XVIII Disadvantaged Business Enterprises (DBE) Participation

- A. CONTRACTOR, subrecipient (COUNTY), or Subcontractor shall take necessary and reasonable steps to ensure that DBEs have opportunities to participate in the contract (49 CFR 26). To ensure equal participation of DBEs provided in 49 CFR 26.5, The COUNTY shows a contract goal for DBEs. CONTRACTOR shall make work available to DBEs and select work parts consistent with available DBE Subcontractor s and suppliers.

CONTRACTOR shall meet the DBE goal shown elsewhere in these special provisions or demonstrate that they made adequate good faith efforts to meet this goal. It is CONTRACTOR 's responsibility to verify that

Appendix III
EXHIBIT B – FEDERAL PROVISIONS
CALTRANS LOCAL ASSISTANCE PROCEDURES MANUAL

the DBE firm is certified as DBE at date of proposal opening and document the record by printing out the California Unified Certification Program (CUCP) data for each DBE firm. A list of DBEs certified by the CUCP can be found [here](#).

All DBE participation will count toward the California Department of Transportation's federally mandated statewide overall DBE goal. Credit for materials or supplies CONTRACTOR purchases from DBEs counts towards the goal in the following manner:

- 100 percent counts if the materials or supplies are obtained from a DBE manufacturer.
- 60 percent counts if the materials or supplies are purchased from a DBE regular dealer.
- Only fees, commissions, and charges for assistance in the procurement and delivery of materials or supplies count if obtained from a DBE that is neither a manufacturer nor regular dealer. 49CFR26.55 defines "manufacturer" and "regular dealer."

This AGREEMENT is subject to 49 CFR Part 26 entitled "Participation by Disadvantaged Business Enterprises in Department of Transportation Financial Assistance Programs". CONTRACTORS who enter into a federally-funded agreement will assist the COUNTY in a good faith effort to achieve California's statewide overall DBE goal.

- B. The goal for DBE participation for this AGREEMENT is _____%. Participation by DBE contractor or subcontractors shall be in accordance with information contained in Exhibit 10-02: Consultant Contract DBE Commitment attached hereto and incorporated as part of the AGREEMENT. If a DBE subcontractor is unable to perform, CONTRACTOR must make a good faith effort to replace him/her with another DBE subcontractor, if the goal is not otherwise met.
- C. CONTRACTOR can meet the DBE participation goal by either documenting commitments to DBEs to meet the AGREEMENT goal, or by documenting adequate good faith efforts to meet the AGREEMENT goal. An adequate good faith effort means that the CONTRACTOR must show that it took all necessary and reasonable steps to achieve a DBE goal that, by their scope, intensity, and appropriateness to the objective, could reasonably be expected to meet the DBE goal. If CONTRACTOR has not met the DBE goal, complete and submit Exhibit 15-H: DBE Information – Good Faith Efforts to document efforts to meet the goal. Refer to 49 CFR Part 26 for guidance regarding evaluation of good faith efforts to meet the DBE goal.

D. Contract Assurance

Under 49 CFR 26.13(b)

CONTRACTOR, subrecipient or subcontractor shall not discriminate on the basis of race, color, national origin, or sex in the performance of this AGREEMENT. CONTRACTOR shall carry out applicable requirements of 49 CFR 26 in the award and administration of federal-aid contracts.

Failure by the CONTRACTOR to carry out these requirements is a material breach of this contract, which may result in the termination of this contract or such other remedy as the recipient deems appropriate, which may include, but is not limited to:

- (1) Withholding monthly progress payments;
- (2) Assessing sanctions;
- (3) Liquidated damages; and/or
- (4) Disqualifying the CONTRACTOR from future proposing as non-responsible

Appendix III
EXHIBIT B – FEDERAL PROVISIONS
CALTRANS LOCAL ASSISTANCE PROCEDURES MANUAL

E. Termination and Substitution of DBE Subcontractors

CONTRACTOR shall utilize the specific DBEs listed to perform the work and supply the materials for which each is listed unless CONTRACTOR or DBE Subcontractor obtains the COUNTY's written consent. CONTRACTOR shall not terminate or substitute a listed DBE for convenience and perform the work with their own forces or obtain materials from other sources without authorization from the COUNTY. Unless the COUNTY's consent is provided, the CONTRACTOR shall not be entitled to any payment for work or material unless it is performed or supplied by the listed DBE on the Exhibit 10-02 Consultant Contract DBE Commitment form, included in the Bid.

The COUNTY authorizes a request to use other forces or sources of materials if CONTRACTOR shows any of the following justifications:

1. Listed DBE fails or refuses to execute a written contract based on plans and specifications for the project.
2. The COUNTY stipulated that a bond is a condition of executing the subcontract and the listed DBE fails to meet the COUNTY's bond requirements.
3. Work requires a contractor's license and listed DBE does not have a valid license under Contractors License Law.
4. Listed DBE fails or refuses to perform the work or furnish the listed materials (failing or refusing to perform is not an allowable reason to remove a DBE if the failure or refusal is a result of bad faith or discrimination).
5. Listed DBE's work is unsatisfactory and not in compliance with the contract.
6. Listed DBE is ineligible to work on the project because of suspension or debarment.
7. Listed DBE becomes bankrupt or insolvent.
8. Listed DBE voluntarily withdraws with written notice from the AGREEMENT.
9. Listed DBE is ineligible to receive credit for the type of work required.
10. Listed DBE owner dies or becomes disabled resulting in the inability to perform the work on the AGREEMENT
11. The COUNTY determines other documented good cause.

CONTRACTOR shall notify the original DBE of the intent to use other forces or material sources and provide the reasons and provide the DBE with 5 days to respond to the notice and advise CONTRACTOR and the COUNTY of the reasons why the use of other forces or sources of materials should not occur.

CONTRACTOR's request to use other forces or material sources must include:

1. One or more of the reasons listed in the preceding paragraph.
2. Notices from CONTRACTOR to the DBE regarding the request.
3. Notices from the DBEs to CONTRACTOR regarding the request.

If a listed DBE is terminated or substituted, CONTRACTOR must make good faith efforts to find another DBE to substitute for the original DBE. The substitute DBE must perform at least the same amount of work as the original DBE under the contract to the extent needed to meet or exceed the DBE goal.

F. Commitment and Utilization

Appendix III
EXHIBIT B – FEDERAL PROVISIONS
CALTRANS LOCAL ASSISTANCE PROCEDURES MANUAL

The COUNTY's DBE program must include a monitoring and enforcement mechanism to ensure that DBE commitments reconcile to DBE utilization. The COUNTY shall request CONTRACTOR to:

1. Notify the COUNTY's contract administrator or designated representative of any changes to its anticipated DBE participation
2. Provide this notification before starting the affected work
3. Maintain records including:
 - Name and business address of each 1st-tier Subcontractor
 - Name and business address of each DBE Subcontractor, DBE vendor, and DBE trucking company, regardless of tier
 - Date of payment and total amount paid to each business (see Exhibit 9-F *Monthly Disadvantaged Business Enterprise Payment*)

If CONTRACTOR is a DBE CONTRACTOR, they shall include the date of work performed by their own forces and the corresponding value of the work.

If a DBE is decertified before completing its work, the DBE must notify CONTRACTOR in writing of the decertification date. If a business becomes a certified DBE before completing its work, the business must notify CONTRACTOR in writing of the certification date. CONTRACTOR shall submit the notifications to the COUNTY. On work completion, CONTRACTOR shall complete a Disadvantaged Business Enterprises (DBE) Certification Status Change, Exhibit 17-O, form and submit the form to the COUNTY within 30 days of contract acceptance.

Upon work completion, CONTRACTOR shall complete Exhibit 17-F Final Report – Utilization of Disadvantaged Business Enterprises (DBE), First-Tier Subcontractors and submit it to the COUNTY within 90 days of contract acceptance. The COUNTY will withhold \$10,000 until the form is submitted. The COUNTY will release the withhold upon submission of the completed form.

In the COUNTY's reports of DBE participation to Caltrans, the COUNTY must display both commitments and attainments.

- G. A DBE is only eligible to be counted toward the AGREEMENT goal if it performs a Commercially Useful Function (CUF) on the AGREEMENT. CUF must be evaluated on an agreement by agreement basis. A DBE performs a CUF when it is responsible for execution of the work of the AGREEMENT and is carrying out its responsibilities by actually performing, managing, and supervising the work involved. To perform a CUF, the DBE must also be responsible, with respect to materials and supplies used on the AGREEMENT, for negotiating price, determining quality and quantity, ordering the material, and installing (where applicable), and paying for the material itself. To determine whether a DBE is performing a CUF, evaluate the amount of work subcontracted, industry practices, whether the amount the firm is to be paid under the AGREEMENT is commensurate with the work it is actually performing, and other relevant factors.
- H. A DBE does not perform a CUF if its role is limited to that of an extra participant in a transaction, AGREEMENT, or project through which funds are passed in order to obtain the appearance of DBE participation. In determining whether a DBE is such an extra participant, examine similar transactions, particularly those in which DBEs do not participate.
- I. If a DBE does not perform or exercise responsibility for at least thirty percent (30%) of the total

Appendix III
EXHIBIT B – FEDERAL PROVISIONS
CALTRANS LOCAL ASSISTANCE PROCEDURES MANUAL

cost of its AGREEMENT with its own work force, or the DBE subcontracts a greater portion of the work of the AGREEMENT than would be expected on the basis of normal industry practice for the type of work involved, it will be presumed that it is not performing a CUF.

- J. CONTRACTOR shall maintain records of materials purchased or supplied from all subcontracts entered into with certified DBEs. The records shall show the name and business address of each DBE or vendor and the total dollar amount actually paid each DBE or vendor, regardless of tier. The records shall show the date of payment and the total dollar figure paid to all firms. DBE contractors shall also show the date of work performed by their own forces along with the corresponding dollar value of the work.
- K. If a DBE subcontractor is decertified during the life of the AGREEMENT, the decertified subcontractor shall notify CONTRACTOR in writing with the date of decertification. If a subcontractor becomes a certified DBE during the life of the AGREEMENT, the subcontractor shall notify CONTRACTOR in writing with the date of certification. Any changes should be reported to COUNTY's Contract Administrator within thirty (30) calendar days.
- L. After submitting an invoice for reimbursement that includes a payment to a DBE, but no later than the 10th of the following month, the prime contractor/consultant shall complete and email the Exhibit 9- F: Disadvantaged Business Enterprise Running Tally of Payments to business.support.unit@dot.ca.gov with a copy to the Agency.
- M. Any subcontract entered into as a result of this AGREEMENT shall contain all of the provisions of this section.

Article XIX Insurance

(Choose either Option 1 or Option 2)

(Option 1 – For AGREEMENT with a scope of services that may require the CONTRACTOR or subcontractor to work within the operating state or County Highway Right of Way; where there would be exposure to public traffic or construction operations.)

- A. Prior to commencement of the work described herein, CONTRACTOR shall furnish COUNTY a Certificate of Insurance stating that there is general comprehensive liability insurance presently in effect for CONTRACTOR with a combined single limit (CSL) of not less than one million dollars (\$1,000,000) per occurrence.
- B. The Certificate of Insurance will provide:
 - 1. That the insurer will not cancel the insured's coverage without thirty (30) calendar days prior written notice to COUNTY.
 - 2. That COUNTY, its officers, agents, employees, and servants are included as additional insureds, but only insofar as the operations under this AGREEMENT are concerned.
 - 3. That COUNTY will not be responsible for any premiums or assessments on the policy.

Appendix III
EXHIBIT B – FEDERAL PROVISIONS
CALTRANS LOCAL ASSISTANCE PROCEDURES MANUAL

- C. CONTRACTOR agrees that the bodily injury liability insurance herein provided for, shall be in effect at all times during the term of this AGREEMENT. In the event said insurance coverage expires at any time or times during the term of this AGREEMENT, CONTRACTOR agrees to provide at least thirty (30) calendar days prior notice to said expiration date; and a new Certificate of Insurance evidencing insurance coverage as provided for herein, for not less than either the remainder of the term of the AGREEMENT, or for a period of not less than one (1) year. New Certificates of Insurance are subject to the approval of COUNTY. In the event CONTRACTOR fails to keep in effect at all times insurance coverage as herein provided, COUNTY may, in addition to any other remedies it may have, terminate this AGREEMENT upon occurrence of such event.

(Option 2 – For AGREEMENTS with a scope of services that will not require the Contractor or subcontractor to work within the operating State or COUNTY Highway Right of Way where there would be exposure to public traffic or construction Contractor operations.)

CONTRACTOR is not required to show evidence of general comprehensive liability insurance.

Article XX Funding Requirements

- A. It is mutually understood between the parties that this AGREEMENT may have been written before ascertaining the availability of funds or appropriation of funds, for the mutual benefit of both parties, in order to avoid program and fiscal delays that would occur if the AGREEMENTs were executed after that determination was made.
- B. This AGREEMENT is valid and enforceable only if sufficient funds are made available to COUNTY for the purpose of this AGREEMENT. In addition, this AGREEMENT is subject to any additional restrictions, limitations, conditions, or any statute enacted by the Congress, State Legislature, or COUNTY governing board that may affect the provisions, terms, or funding of this AGREEMENT in any manner.
- C. It is mutually agreed that if sufficient funds are not appropriated, this AGREEMENT may be amended to reflect any reduction in funds.
- D. COUNTY has the option to terminate the AGREEMENT pursuant to Article VI Termination, or by mutual agreement to amend the AGREEMENT to reflect any reduction of funds.

Article XXI Change in Terms

- A. This AGREEMENT may be amended or modified only by mutual written agreement of the parties.
- B. CONTRACTOR shall only commence work covered by an amendment after the amendment is executed and notification to proceed has been provided by COUNTY's Contract Administrator.
- C. There shall be no change in CONTRACTOR's Project Manager or members of the project team, as listed in the approved Cost Proposal, which is a part of this AGREEMENT without prior written approval by COUNTY's Contract Administrator.

Appendix III
EXHIBIT B – FEDERAL PROVISIONS
CALTRANS LOCAL ASSISTANCE PROCEDURES MANUAL

Article XXI Contingent Fee

CONTRACTOR warrants, by execution of this AGREEMENT that no person or selling agency has been employed, or retained, to solicit or secure this AGREEMENT upon an agreement or understanding, for a commission, percentage, brokerage, or contingent fee, excepting bona fide employees, or bona fide established commercial or selling agencies maintained by CONTRACTOR for the purpose of securing business. For breach or violation of this warranty, COUNTY has the right to annul this AGREEMENT without liability; pay only for the value of the work actually performed, or in its discretion to deduct from the AGREEMENT price or consideration, or otherwise recover the full amount of such commission, percentage, brokerage, or contingent fee.

Article XXII Disputes

Prior to either party commencing any legal action under this AGREEMENT, the parties agree to try in good faith, to settle any dispute amicably between them. If a dispute has not been settled after forty-five (45) days of good-faith negotiations and as may be otherwise provided herein, then either party may commence legal action against the other.

(Choose either Option 1 or Option 2)

(Option 1- Use paragraphs A through C below for all AGREEMENTs without PS&E submittal)

- A. Any dispute, other than audit, concerning a question of fact arising under this AGREEMENT that is not disposed of by agreement shall be decided by a committee consisting of COUNTY's Contract Administrator and _____, who may consider written or verbal information submitted by CONTRACTOR.
- B. Not later than thirty (30) calendar days after completion of all work under the contract, CONTRACTOR may request review by COUNTY Governing Board of unresolved claims or disputes, other than audit. The request for review will be submitted in writing.
- C. Neither the pendency of a dispute, nor its consideration by the committee will excuse CONTRACTOR from full and timely performance in accordance with the terms of this AGREEMENT.

(Option 2 – Replace Paragraph B, above, with the following for AGREEMENTs requiring the submission of PS&E)

- B. Not later than thirty (30) calendar days after completion of all deliverables necessary to complete the plans, specifications and estimate, CONTRACTOR may request review by COUNTY Governing Board of unresolved claims or disputes, other than audit. The request for review will be submitted in writing.

Article XXIV Inspection of Work

CONTRACTOR and any subcontractor shall permit COUNTY, the state, and the FHWA if federal participating funds are used in this AGREEMENT; to review and inspect the project activities and files at all reasonable times during the performance period of this AGREEMENT.

Appendix III
EXHIBIT B – FEDERAL PROVISIONS
CALTRANS LOCAL ASSISTANCE PROCEDURES MANUAL

Article XXV Safety

- A. CONTRACTOR shall comply with OSHA regulations applicable to CONTRACTOR regarding necessary safety equipment or procedures. CONTRACTOR shall comply with safety instructions issued by COUNTY Safety Officer and other COUNTY representatives. CONTRACTOR personnel shall wear hard hats and safety vests at all times while working on the construction project site.

- B. Pursuant to the authority contained in Vehicle Code §591, COUNTY has determined that such areas are within the limits of the project and are open to public traffic. CONTRACTOR shall comply with all of the requirements set forth in Divisions 11, 12, 13, 14, and 15 of the Vehicle Code. CONTRACTOR shall take all reasonably necessary precautions for safe operation of its vehicles and the protection of the traveling public from injury and damage from such vehicles.

(Add the following paragraph to all AGREEMENTS which may require trenching of five feet or deeper)

- C. CONTRACTOR must have a Division of Occupational Safety and Health (CAL-OSHA) permit(s), as outlined in Labor Code §6500 and §6705, prior to the initiation of any practices, work, method, operation, or process related to the construction or excavation of trenches which are five (5) feet or deeper.

Article XXVI Ownership of Data

- A. It is mutually agreed that all materials prepared by CONTRACTOR under this AGREEMENT shall become the property of COUNTY, and CONTRACTOR shall have no property right therein whatsoever. Immediately upon termination, COUNTY shall be entitled to, and CONTRACTOR shall deliver to COUNTY, reports, investigations, appraisals, inventories, studies, analyses, drawings and data estimates performed to that date, whether completed or not, and other such materials as may have been prepared or accumulated to date by CONTRACTOR in performing this AGREEMENT which is not CONTRACTOR's privileged information, as defined by law, or CONTRACTOR's personnel information, along with all other property belonging exclusively to COUNTY which is in CONTRACTOR's possession. Publication of the information derived from work performed or data obtained in connection with services rendered under this AGREEMENT must be approved in writing by COUNTY.

- B. Additionally, it is agreed that the Parties intend this to be an AGREEMENT for services and each considers the products and results of the services to be rendered by CONTRACTOR hereunder to be work made for hire. CONTRACTOR acknowledges and agrees that the work (and all rights therein, including, without limitation, copyright) belongs to and shall be the sole and exclusive property of COUNTY without restriction or limitation upon its use or dissemination by COUNTY.

- C. Nothing herein shall constitute or be construed to be any representation by CONTRACTOR that the work product is suitable in any way for any other project except the one detailed in this Contract. Any reuse by COUNTY for another project or project location shall be at COUNTY's sole risk. Applicable patent rights provisions regarding rights to inventions shall be included in the contracts as appropriate (48 CFR 27, Subpart 27.3 - Patent Rights under Government Contracts for

Released September 2020
11/02/21

Appendix III
EXHIBIT B – FEDERAL PROVISIONS
CALTRANS LOCAL ASSISTANCE PROCEDURES MANUAL

federal-aid contracts).

- D. COUNTY may permit copyrighting reports or other agreement products. If copyrights are permitted; the AGREEMENT shall provide that the FHWA shall have the royalty-free nonexclusive and irrevocable right to reproduce, publish, or otherwise use; and to authorize others to use, the work for government purposes.

Article XXVII Claims Filed by County's Construction Contractor

- A. If claims are filed by COUNTY's construction contractor relating to work performed by CONTRACTOR's personnel, and additional information or assistance from CONTRACTOR's personnel is required in order to evaluate or defend against such claims; CONTRACTOR agrees to make its personnel available for consultation with COUNTY'S construction contract administration and legal staff and for testimony, if necessary, at depositions and at trial or arbitration proceedings.
- B. CONTRACTOR's personnel that COUNTY considers essential to assist in defending against construction contractor claims will be made available on reasonable notice from COUNTY. Consultation or testimony will be reimbursed at the same rates, including travel costs that are being paid for CONTRACTOR's personnel services under this AGREEMENT.
- C. Services of CONTRACTOR's personnel in connection with COUNTY's construction contractor claims will be performed pursuant to a written contract amendment, if necessary, extending the termination date of this AGREEMENT in order to resolve the construction claims.

Article XXVIII Confidentiality of Data

- A. All financial, statistical, personal, technical, or other data and information relative to COUNTY's operations, which are designated confidential by COUNTY and made available to CONTRACTOR in order to carry out this AGREEMENT, shall be protected by CONTRACTOR from unauthorized use and disclosure.
- B. Permission to disclose information on one occasion, or public hearing held by COUNTY relating to the AGREEMENT, shall not authorize CONTRACTOR to further disclose such information, or disseminate the same on any other occasion.
- C. CONTRACTOR shall not comment publicly to the press or any other media regarding the contract or COUNTY's actions on the same, except to COUNTY's staff, CONTRACTOR's own personnel involved in the performance of this AGREEMENT, at public hearings or in response to questions from a Legislative committee.
- D. CONTRACTOR shall not issue any news release or public relations item of any nature, whatsoever, regarding work performed or to be performed under this contract without prior review of the contents thereof by COUNTY, and receipt of COUNTY'S written permission.

(For PS&E contracts, add paragraph F below, to paragraphs A through E above)

Released September 2020
11/02/21

Appendix III
EXHIBIT B – FEDERAL PROVISIONS
CALTRANS LOCAL ASSISTANCE PROCEDURES MANUAL

- E. All information related to the construction estimate is confidential, and shall not be disclosed by CONTRACTOR to any entity other than COUNTY, Caltrans, and/or FHWA. All of the materials prepared or assembled by CONTRACTOR pursuant to performance of this Contract are confidential and CONTRACTOR agrees that they shall not be made available to any individual or organization without the prior written approval of COUNTY or except by court order. If CONTRACTOR or any of its officers, employees, or subcontractors does voluntarily provide information in violation of this Contract, COUNTY has the right to reimbursement and indemnity from CONTRACTOR for any damages caused by CONTRACTOR releasing the information, including, but not limited to, COUNTY's attorney's fees and disbursements, including without limitation experts' fees and disbursements.

Article XXIX National Labor Relations Board Certification

In accordance with Public Contract Code Section 10296, CONTRACTOR hereby states under penalty of perjury that no more than one final unappealable finding of contempt of court by a federal court has been issued against CONTRACTOR within the immediately preceding two-year period, because of CONTRACTOR's failure to comply with an order of a federal court that orders CONTRACTOR to comply with an order of the National Labor Relations Board.

Article XXX Evaluation of Contractor

CONTRACTOR's performance will be evaluated by COUNTY. A copy of the evaluation will be sent to CONTRACTOR for comments. The evaluation together with the comments shall be retained as part of the AGREEMENT record.

Article XXXI Prompt Payment from the County to the Contractor

The COUNTY shall make any progress payment within 30 days after receipt of an undisputed and properly submitted payment request from CONTRACTOR on a professional service contract. If the COUNTY fails to pay promptly, the COUNTY shall pay interest to the contractor, which accrues at the rate of 10 percent per annum on the principal amount of a money judgment remaining unsatisfied. Upon receipt of a payment request, the COUNTY shall act in accordance with both of the following:

- (1) Each payment request shall be reviewed by the COUNTY as soon as practicable after receipt for the purpose of determining that the payment request is a proper payment request.
- (2) Any payment request determined not to be a proper payment request suitable for payment shall be returned to CONTRACTOR as soon as practicable, but not later than seven (7) days, after receipt. A request returned pursuant to this paragraph shall be accompanied by a document setting forth in writing the reasons why the payment request is not proper.

ARTICLE XXXII NOTIFICATION

All notices hereunder and communications regarding interpretation of the terms of this AGREEMENT and

Released September 2020
11/02/21

Appendix III
EXHIBIT B – FEDERAL PROVISIONS
CALTRANS LOCAL ASSISTANCE PROCEDURES MANUAL

changes thereto, shall be effected by the mailing thereof by registered or certified mail, return receipt requested, postage prepaid, and addressed as follows:

CONTRACTOR:

_____, Project Manager

COUNTY:

_____, Contract Administrator

ARTICLE XXXIII CONTRACT

The two parties to this AGREEMENT, who are the before named CONTRACTOR and the COUNTY, hereby agree that this AGREEMENT constitutes the entire AGREEMENT which is made and concluded in duplicate between the two parties. Both of these parties for and in consideration of the payments to be made, conditions mentioned, and work to be performed; each agree to diligently perform in accordance with the terms and conditions of this AGREEMENT as evidenced by the signatures below.

ARTICLE XXXIV SIGNATURES

(Name of Signer)

(Name of Signer)

Date:

Date:

EXHIBIT B – FEDERAL PROVISIONS
CALTRANS LOCAL ASSISTANCE PROCEDURES MANUAL

CALTRANS LOCAL ASSISTANCE PROCEDURES MANUAL FORMS

The following forms can be viewed and downloaded in fillable format at:

<https://dot.ca.gov/programs/local-assistance/forms/local-assistance-procedures-manual-forms>

EXHIBIT 10-H1 COST PROPOSAL Page 1 of 3

COST-PLUS-FIXED FEE OR LUMP SUM OR FIRM FIXED PRICE CONTRACTS

(DESIGN, ENGINEERING AND ENVIRONMENTAL STUDIES)

Note: Mark-ups are Not Allowed

Prime Consultant Subconsultant 2nd Tier Subconsultant

Consultant _____

Project No. _____ Contract No. _____ Date _____

DIRECT LABOR

Classification/Title	Name	Hours	Actual Hourly Rate	Total
(Project Manager)*	_____	_____	\$ _____	\$ _____
(Sr. Civil Engineer)	_____	_____	\$ _____	\$ _____
(Envir. Scientist)	_____	_____	\$ _____	\$ _____
(Inspector)**	_____	_____	\$ _____	\$ _____

LABOR COSTS

a) Subtotal Direct Labor Costs \$ _____

b) Anticipated Salary Increases (see page 2 for calculation) \$ _____

c) **TOTAL DIRECT LABOR COSTS [(a) + (b)]** \$ _____

INDIRECT COSTS

d) Fringe Benefits (Rate: _____%) e) Total Fringe Benefits [(c) x (d)] \$ _____

f) Overhead (Rate: _____%) g) Overhead [(c) x (f)] \$ _____

h) General and Administrative (Rate: _____%) i) Gen & Admin [(c) x (h)] \$ _____

j) **TOTAL INDIRECT COSTS [(e) + (g) + (i)]** \$ _____

FIXED FEE

k) **TOTAL FIXED FEE [(c) + (j)] x fixed fee _____%** \$ _____

l) CONSULTANT'S OTHER DIRECT COSTS (ODC) – ITEMIZE (Add additional pages if necessary)

Description of Item	Quantity	Unit	Unit Cost	Total
Mileage Costs			\$	\$
Equipment Rental and Supplies			\$	\$
Permit Fees			\$	\$
Plan Sheets			\$	\$
Test			\$	\$

l) **TOTAL OTHER DIRECT COSTS** \$ _____

m) SUBCONSULTANTS' COSTS (Add additional pages if necessary)

Subconsultant 1: \$ _____

Subconsultant 2: \$ _____

Subconsultant 3: \$ _____

Subconsultant 4: \$ _____

m) **TOTAL SUBCONSULTANTS' COSTS** \$ _____

n) **TOTAL OTHER DIRECT COSTS INCLUDING SUBCONSULTANTS [(l)+(m)]** \$ _____

TOTAL COST [(c) + (j) + (k) + (n)] \$ _____

NOTES:

- Key personnel **must** be marked with an asterisk (*) and employees that are subject to prevailing wage requirements must be marked with two asterisks (**). All costs must comply with the Federal cost principles. Subconsultants will provide their own cost proposals.

2. The cost proposal format shall not be amended. Indirect cost rates shall be updated on an annual basis in accordance with the consultant's annual accounting period and established by a cognizant agency or accepted by Caltrans.
3. Anticipated salary increases calculation (page 2) must accompany.

EXHIBIT 10-H1 COST PROPOSAL Page 2 of 3**COST-PLUS-FIXED FEE OR LUMP SUM OR FIRM FIXED PRICE CONTRACTS**

(CALCULATIONS FOR ANTICIPATED SALARY INCREASES)

1. Calculate Average Hourly Rate for 1st year of the contract (Direct Labor Subtotal divided by total hours)

Direct Labor Subtotal per Cost Proposal	Total Hours per Cost Proposal		Avg Hourly Rate	5 Year Contract Duration
\$250,000.00	5000	=	\$50.00	Year 1 Avg Hourly Rate

2. Calculate hourly rate for all years (Increase the Average Hourly Rate for a year by proposed escalation %)

	Avg Hourly Rate		Proposed Escalation			
Year 1	\$50.00	+	2%	=	\$51.00	Year 2 Avg Hourly Rate
Year 2	\$51.00	+	2%	=	\$52.02	Year 3 Avg Hourly Rate
Year 3	\$52.02	+	2%	=	\$53.06	Year 4 Avg Hourly Rate
Year 4	\$53.06	+	2%	=	\$54.12	Year 5 Avg Hourly Rate

3. Calculate estimated hours per year (Multiply estimate % each year by total hours)

	Estimated % Completed Each Year	*	Total Hours per Cost Proposal	=	Total Hours per Year	
Year 1	20.0%	*	5000	=	1000	Estimated Hours Year 1
Year 2	40.0%	*	5000	=	2000	Estimated Hours Year 2
Year 3	15.0%	*	5000	=	750	Estimated Hours Year 3
Year 4	15.0%	*	5000	=	750	Estimated Hours Year 4
Year 5	10.0%	*	5000	=	500	Estimated Hours Year 5
Total	100%		Total	=	5000	

4. Calculate Total Costs including Escalation (Multiply Average Hourly Rate by the number of hours)

	Avg Hourly Rate (calculated above)	*	Estimated hours (calculated above)	=	Cost per Year	
Year 1	\$50.00	*	1000	=	\$50,000.00	Estimated Hours Year 1
Year 2	\$51.00	*	2000	=	\$102,000.00	Estimated Hours Year 2
Year 3	\$52.02	*	750	=	\$39,015.00	Estimated Hours Year 3
Year 4	\$53.06	*	750	=	\$39,795.30	Estimated Hours Year 4
Year 5	\$54.12	*	500	=	\$27,060.80	Estimated Hours Year 5
Total Direct Labor Cost with Escalation				=	\$257,871.10	
Direct Labor Subtotal before Escalation				=	\$250,000.00	
Estimated total of Direct Labor Salary Increase				=	\$7,871.10	Transfer to Page 1

NOTES:

1. This is not the only way to estimate salary increases. Other methods will be accepted if they clearly indicate the % increase, the # of years of the contract, and a breakdown of the labor to be performed each year.
2. An estimation that is based on direct labor multiplied by salary increase % multiplied by the # of years is not acceptable. (i.e. \$250,000 x 2% x 5 yrs = \$25,000 is not an acceptable methodology)
3. This assumes that one year will be worked at the rate on the cost proposal before salary increases are granted.
4. Calculations for anticipated salary escalation must be provided.

EXHIBIT 10-H1 COST PROPOSAL Page 3 of 3

Certification of Direct Costs:

I, the undersigned, certify to the best of my knowledge and belief that all direct costs identified on the cost proposal(s) in this contract are actual, reasonable, allowable, and allocable to the contract in accordance with the contract terms and the following requirements:

1. Generally Accepted Accounting Principles (GAAP)
2. Terms and conditions of the contract
3. [Title 23 United States Code Section 112](#) - Letting of Contracts
4. [48 Code of Federal Regulations Part 31](#) - Contract Cost Principles and Procedures
5. [23 Code of Federal Regulations Part 172](#) - Procurement, Management, and Administration of Engineering and Design Related Service
6. [48 Code of Federal Regulations Part 9904 - Cost Accounting Standards Board](#) (when applicable)

All costs must be applied consistently and fairly to all contracts. All documentation of compliance must be retained in the project files and be in compliance with applicable federal and state requirements. Costs that are noncompliant with the federal and state requirements are not eligible for reimbursement. Local governments are responsible for applying only cognizant agency approved or Caltrans accepted Indirect Cost Rate(s).

Prime Consultant or Subconsultant Certifying:

Name: _____ Title *: _____

Signature : _____ Date of Certification (mm/dd/yyyy): _____

Email: _____ Phone Number: _____

Address: _____

*An individual executive or financial officer of the consultant’s or subconsultant’s organization at a level no lower than a Vice President or a Chief Financial Officer, or equivalent, who has authority to represent the financial information utilized to establish the cost proposal for the contract.

List services the consultant is providing under the proposed contract:

EXHIBIT 10-H2 COST PROPOSAL Page 1 of 3

SPECIFIC RATE OF COMPENSATION (USE FOR ON-CALL OR AS-NEEDED CONTRACTS)
(CONSTRUCTION ENGINEERING AND INSPECTION CONTRACTS)

Note: Mark-ups are Not Allowed

Consultant _____ Prime Consultant Subconsultant 2nd Tier Subconsultant

Project No. _____ Contract No. _____ Participation Amount \$ _____ Date _____

For Combined Rate	Fringe Benefit % + General & Administrative %	=	Combined ICR%
OR			
For Home Office Rate	Fringe Benefit % + General & Administrative %	=	Home Office ICR%
For Field Office Rate	Fringe Benefit % + General & Administrative %	=	Field Office ICR%

Fee	=	%
-----	---	---

BILLING INFORMATION

CALCULATION INFORMATION

Name/Job Title/Classification ¹	Hourly Billing Rates ²			Effective Date of Hourly Rate		Actual or Avg. Hourly Rate ⁴	% or \$ Increase	Hourly Range - for Classifications Only
	Straight ³	OT(1.5x)	OT(2x)	From	To			
John Doe – Project Manager * Civil Engineer II	\$0.00	\$0.00	\$0.00	01/01/2016	12/31/2016	\$0.00		Not Applicable
	\$0.00	\$0.00	\$0.00	01/01/2017	12/31/2017	\$0.00	0.0%	
	\$0.00	\$0.00	\$0.00	01/01/2018	12/31/2018	\$0.00	0.0%	
Sue Jones – Construction Engineer/Inspector Engineer I	\$0.00	\$0.00	\$0.00	01/01/2016	12/31/2016	\$0.00		Not Applicable
	\$0.00	\$0.00	\$0.00	01/01/2017	12/31/2017	\$0.00	0.0%	
	\$0.00	\$0.00	\$0.00	01/01/2018	12/31/2018	\$0.00	0.0%	
Buddy Black – Claims Engineer Engineer III	\$0.00	\$0.00	\$0.00	01/01/2016	12/31/2016	\$0.00		Not Applicable
	\$0.00	\$0.00	\$0.00	01/01/2017	12/31/2017	\$0.00	0.0%	
	\$0.00	\$0.00	\$0.00	01/01/2018	12/31/2018	\$0.00	0.0%	
Land Surveyor **	\$0.00	\$0.00	\$0.00	01/01/2016	12/31/2016	\$0.00		\$00 - \$00
	\$0.00	\$0.00	\$0.00	01/01/2017	12/31/2017	\$0.00	0.0%	\$00 - \$00
	\$0.00	\$0.00	\$0.00	01/01/2018	12/31/2018	\$0.00	0.0%	\$00 - \$00
Technician	\$0.00	\$0.00	\$0.00	01/01/2016	12/31/2016	\$0.00		\$00 - \$00
	\$0.00	\$0.00	\$0.00	01/01/2017	12/31/2017	\$0.00	0.0%	\$00 - \$00
	\$0.00	\$0.00	\$0.00	01/01/2018	12/31/2018	\$0.00	0.0%	\$00 - \$00

(Add pages as necessary)

NOTES:

1. Key personnel **must** be marked with an asterisk (*) and employees that are subject to prevailing wage requirements must be marked with two asterisks (**). All costs must comply with the Federal cost principles. Subconsultants will provide their own cost proposals.
2. The cost proposal format shall not be amended.
3. Billing rate = actual hourly rate * (1+ ICR) * (1+ Fee). Indirect cost rates shall be updated on an annual basis in accordance with the consultant's annual accounting period and established by a cognizant agency or accepted by Caltrans. All costs must comply with the Federal cost principles for reimbursement.
4. For named employees and key personnel enter the actual hourly rate. For classifications only, enter the Average Hourly Rate for that classification.

EXHIBIT 10-H2 COST PROPOSAL Page 2 of 3

SPECIFIC RATE OF COMPENSATION (USE FOR ON-CALL OR AS-NEEDED CONTRACTS)
(CONSTRUCTION ENGINEERING AND INSPECTION CONTRACTS)

Consultant _____ Prime Consultant Subconsultant

Project No. _____ Contract No. _____ Date _____

SCHEDULE OF OTHER DIRECT COST ITEMS (Add additional pages as necessary)				
Description of Item	Quantity	Unit	Unit Cost	Total
Mileage Costs			\$	\$
Equipment Rental and Supplies			\$	\$
Permit Fees			\$	\$
Plan Sheets			\$	\$
Test			\$	\$
Vehicle			\$	\$
Subconsultant 1:				\$
Subconsultant 2:				\$
Subconsultant 3:				\$
Subconsultant 4:				\$
Subconsultant 5:				\$

Note: Add additional pages if necessary.

NOTES:

1. List other direct cost items with estimated costs. These costs should be competitive in their respective industries and supported with appropriate documentation.
2. Proposed ODC items should be consistently billed regardless of client and contract type.
3. Items when incurred for the same purpose, in like circumstance, should not be included in any indirect cost pool or in the overhead rate.
4. Items such as special tooling, will be reimbursed at actual cost with supporting documentation (invoice).

5. Items listed above that would be considered "tools of the trade" are not reimbursable as other direct cost.
6. Travel related costs should be pre-approved by the contracting agency and shall not exceed current State Department of Personnel Administration rules.
7. If mileage is claimed, the rate should be properly supported by the consultant's calculation of their actual costs for company vehicles. In addition, the miles claimed should be supported by mileage logs.
8. If a consultant proposes rental costs for a vehicle, the company must demonstrate that this is its standard procedure for all of their contracts and that they do not own any vehicles that could be used for the same purpose.
9. The cost proposal format shall not be amended. All costs must comply with the Federal cost principles.
10. Add additional pages if necessary.
11. Subconsultants must provide their own cost proposals.

EXHIBIT 10-H2 COST PROPOSAL Page 3 of 3

Certification of Direct Costs:

I, the undersigned, certify to the best of my knowledge and belief that all direct costs identified on the cost proposal(s) in this contract are actual, reasonable, allowable, and allocable to the contract in accordance with the contract terms and the following requirements:

- 7. Generally Accepted Accounting Principles (GAAP)
- 8. Terms and conditions of the contract
- 9. [Title 23 United States Code Section 112](#) - Letting of Contracts
- 10. [48 Code of Federal Regulations Part 31](#) - Contract Cost Principles and Procedures
- 11. [23 Code of Federal Regulations Part 172](#) - Procurement, Management, and Administration of Engineering and Design Related Service
- 12. [48 Code of Federal Regulations Part 9904 - Cost Accounting Standards Board](#) (when applicable)

All costs must be applied consistently and fairly to all contracts. All documentation of compliance must be retained in the project files and be in compliance with applicable federal and state requirements. Costs that are noncompliant with the federal and state requirements are not eligible for reimbursement.

Prime Consultant or Subconsultant Certifying:

Name: _____ Title *: _____

Signature : _____ Date of Certification (mm/dd/yyyy): _____

Email: _____ Phone Number: _____

Address: _____

* An individual executive or financial officer of the consultant’s or subconsultant’s organization at a level no lower than a Vice President or a Chief Financial Officer, or equivalent, who has authority to represent the financial information utilized to establish the cost proposal for the contract.

List services the consultant is providing under the proposed contract:

EXHIBIT 10-H3 COST PROPOSAL Page 1 of 2

COST PER UNIT OF WORK CONTRACTS
(GEOTECHNICAL AND MATERIAL TESTING)

Note: Mark-ups are Not Allowed

Prime Consultant Subconsultant 2nd Tier Subconsultant

Consultant _____

Project No. _____ Contract No. _____ Date _____

Unit/Item of Work:

(Example: Log of Test Boring for Soils Report, or ADL Testing for Hazardous Waste Material Study)

Include as many Items as necessary.

DIRECT LABOR	Hours	Billing Hourly Rate (\$)	Total (\$)
Professional (Classification)*	_____	_____	_____
Sub-professional/Technical**	_____	_____	_____
EQUIPMENT 1 (with Operator)	_____	_____	_____
EQUIPMENT 2 (with Operator)	_____	_____	_____

Consultant's Other Direct Costs (ODC) – Itemize:

Description of Item	Quantity	Unit	Unit Cost	Total
ODC Example: Travel/Mileage Costs			\$	\$
ODC Example: Mobilization/De-mobilization			\$	\$
ODC Example: Supplies/Consumables			\$	\$
ODC Example: Report			\$	\$
ODC (List more ODCs as applicable)			\$	\$
Subconsultant 1:				\$
Subconsultant 2:				\$
Subconsultant 3:				\$
Subconsultant 4:				\$
Subconsultant 5:				\$

Note: Attach additional pages if necessary.

TOTAL COST PER UNIT OF WORK \$ _____

NOTES:

- Key personnel **must** be marked with an asterisk (*) and employees that are subject to prevailing wage requirements must be marked with two asterisks (**). All costs must comply with the Federal cost principles. Subconsultants will provide their own cost proposals. The cost proposal format shall not be amended.
- Hourly billing rates should include prevailing wage rates and be consistent with publicly advertised rates charged to all clients (Commercial, Private or Public).
- Mobilization/De-mobilization is based on site location and number and frequency of tests/items.
- ODC items shall be based on actual costs and supported by historical data and other documentation.
- ODC items that would be considered "tools of the trade" are not reimbursable.
- Billing Hourly Rates must be actual, allowable, and reasonable.

EXHIBIT 10-H3 COST PROPOSAL Page 2 of 2

Certification of Direct Costs:

I, the undersigned, certify to the best of my knowledge and belief that all direct costs identified on the cost proposal(s) in this contract are actual, reasonable, allowable, and allocable to the contract in accordance with the contract terms and the following requirements:

- 13. Generally Accepted Accounting Principles (GAAP)
- 14. Terms and conditions of the contract
- 15. [Title 23 United States Code Section 112](#) - Letting of Contracts
- 16. [48 Code of Federal Regulations Part 31](#) - Contract Cost Principles and Procedures
- 17. [23 Code of Federal Regulations Part 172](#) - Procurement, Management, and Administration of Engineering and Design Related Service
- 18. [48 Code of Federal Regulation Part 9904 - Cost Accounting Standards Board](#) (when applicable)

All costs must be applied consistently and fairly to all contracts. All documentation of compliance must be retained in the project files and be in compliance with applicable federal and state requirements. Costs that are noncompliant with the federal and state requirements are not eligible for reimbursement.

Prime Consultant or Subconsultant Certifying:

Name: _____ Title*: _____

Signature : _____ Date of Certification (mm/dd/yyyy): _____

Email: _____ Phone Number: _____

Address: _____

* An individual executive or financial officer of the consultant’s or subconsultant’s organization at a level no lower than a Vice President or a Chief Financial Officer, or equivalent, who has authority to represent the financial information utilized to establish the cost proposal for the contract.

List services the consultant is providing under the proposed contract:

January 2020

**EXHIBIT 10-K CONSULTANT ANNUAL CERTIFICATION OF
INDIRECT COSTS AND FINANCIAL MANAGEMENT SYSTEM**

(Note: If a Safe Harbor Indirect Cost Rate is approved, this form is not required.)

Consultant's Full Legal Name: _____

Important: Consultant means the individual or consultant providing engineering and design related services as a party of a contract with a recipient or sub-recipient of Federal assistance. Therefore, the Indirect Cost Rate(s) shall not be combined with its parent company or subsidiaries.

Indirect Cost Rate:

Combined Rate _____ % OR

Home Office Rate _____ % and Field Office Rate (if applicable) _____ %

Facilities Capital Cost of Money _____ % (if applicable)

Fiscal period * _____

* Fiscal period is annual one year applicable accounting period that the Indirect Cost Rate was developed (not the contract period). The Indirect Cost Rate is based on the consultant's one-year applicable accounting period for which financial statements are regularly prepared by the consultant.

I have reviewed the proposal to establish an Indirect Cost Rate(s) for the fiscal period as specified above and have determined to the best of my knowledge and belief that:

- All costs included in the cost proposal to establish the indirect cost rate(s) are allowable in accordance with the cost principles of the Federal Acquisition Regulation (FAR) 48, Code of Federal Regulations (CFR), Chapter 1, Part 31 (48 CFR Part 31);
- The cost proposal does not include any costs which are expressly unallowable under the cost principles of 48 CFR Part 31;
- The accounting treatment and billing of prevailing wage delta costs are consistent with our prevailing wage policy as either direct labor, indirect costs, or other direct costs on all federally-funded A&E Consultant Contracts.
- All known material transactions or events that have occurred subsequent to year-end affecting the consultant's ownership, organization, and indirect cost rates have been disclosed as of the date of this certification.

I am providing the required and applicable documents as instructed on Exhibit 10-A.

Financial Management System:

Our labor charging, job costing, and accounting systems meet the standards for financial reporting, accounting records, and internal control adequate to demonstrate that costs claimed have been incurred, appropriately accounted for, are allocable to the contract, and comply with the federal requirements as set forth in Title 23 United States Code (U.S.C.) Section 112(b)(2); 48 CFR Part 31.201-2(d); 23 CFR, Chapter 1, Part 172.11(a)(2); and all applicable state and federal rules and regulations.

Our financial management system has the following attributes:

- Account numbers identifying allowable direct, indirect, and unallowable cost accounts;
- Ability to accumulate and segregate allowable direct, indirect, and unallowable costs into separate cost

Local Assistance Procedures Manual

Local Assistance Procedures Manual**Exhibit 10-K****Consultant Annual Certification of Indirect Costs and Financial Management System**

accounts;

- Ability to accumulate and segregate allowable direct costs by project, contract and type of cost;
- Internal controls to maintain integrity of financial management system;
- Ability to account and record costs consistently and to ensure costs billed are in compliance with FAR;
- Ability to ensure and demonstrate costs billed reconcile to general ledgers and job costing system; and
- Ability to ensure costs are in compliance with contract terms and federal and state requirement

Cost Reimbursements on Contracts:

I also understand that failure to comply with 48 CFR Part 16.301-3 or knowingly charge unallowable costs to Federal-Aid Highway Program (FAHP) contracts may result in possible penalties and sanctions as provided by the following:

- Sanctions and Penalties - [23 CFR Part 172.11\(c\)\(4\)](#)
- False Claims Act - [Title 31 U.S.C. Sections 3729-3733](#)
- Statements or entries generally - [Title 18 U.S.C. Section 1001](#)
- Major Fraud Act - [Title 18 U.S.C. Section 1031](#)

All A&E Contract Information:

- Total participation amount \$ _____ on all State and FAHP contracts for Architectural & Engineering services that the consultant received in the last three fiscal periods.
- The number of states in which the consultant does business is _____.
- Years of consultant's experience with 48 CFR Part 31 is _____.
- Audit history of the consultant's current and prior years (if applicable)

<input type="checkbox"/> Cognizant ICR Audit	<input type="checkbox"/> Local Gov't ICR Audit	<input type="checkbox"/> Caltrans ICR Audit
<input type="checkbox"/> CPA ICR Audit	<input type="checkbox"/> Federal Gov't ICR Audit	

I, the undersigned, certify all of the above to the best of my knowledge and belief and that I have reviewed the Indirect Cost Rate Schedule to determine that any costs which are expressly unallowable under the Federal cost principles have been removed and comply with [Title 23 U.S.C. Section 112\(b\)\(2\)](#), [48 CFR Part 31](#), [23 CFR Part 172](#), and all applicable state and federal rules and regulations. I also certify that I understand that all documentation of compliance must be retained by the consultant. I hereby acknowledge that costs that are noncompliant with the federal and state requirements are not eligible for reimbursement and must be returned to Caltrans.

Name**: _____ Title**: _____

Signature: _____ Date of Certification (mm/dd/yyyy): _____

Email**: _____ Phone Number**: _____

**An individual executive or financial officer of the consultant's or subcontractant's organization at a level no lower than a Vice President, a Chief Financial Officer, or equivalent, who has authority to represent the financial information used to establish the indirect cost rate.

Note: *Both prime and subcontractants as parties of a contract must complete their own Exhibit 10-K forms. Caltrans will not process local agency's invoices until a complete Exhibit 10-K form is accepted and approved by Caltrans Audits and Investigations.*

Distribution: 1) Original - Local Agency Project File
2) Copy - Consultant
3) Copy - Caltrans Audits and Investigations

Reset Form

EXHIBIT 10-01 CONSULTANT PROPOSAL DBE COMMITMENT

1. Local Agency: _____ 2. Contract DBE Goal: _____
 3. Project Description: _____
 4. Project Location: _____
 5. Consultant's Name: _____ 6. Prime Certified DBE:

7. Description of Work, Service, or Materials Supplied	8. DBE Certification Number	9. DBE Contact Information	10. DBE %
<p align="center">Local Agency to Complete this Section</p> 17. Local Agency Contract Number: _____ 18. Federal-Aid Project Number: _____ 19. Proposed Contract Execution Date: _____ 20. Consultant's Ranking after Evaluation: _____ Local Agency certifies that all DBE certifications are valid and information on this form is complete and accurate. _____ _____ _____		<p align="center">11. TOTAL CLAIMED DBE PARTICIPATION %</p>	
		<p>IMPORTANT: Identify all DBE firms being claimed for credit, regardless of tier. Written confirmation of each listed DBE is required.</p> 12. Preparer's Signature _____ 13. Date _____ 14. Preparer's Name _____ 15. Phone _____ 16. Preparer's Title _____	

DISTRIBUTION: Original – Included with consultant's proposal to local agency.

ADA Notice: For individuals with sensory disabilities, this document is available in alternate formats. For information call (916) 654-6410 or TDD (916) 654-3880 or write Records and Forms Management, 1120 N Street, MS-89, Sacramento, CA 95814.

INSTRUCTIONS – CONSULTANT PROPOSAL DBE COMMITMENT**CONSULTANT SECTION**

1. **Local Agency** - Enter the name of the local or regional agency that is funding the contract.
2. **Contract DBE Goal** - Enter the contract DBE goal percentage as it appears on the project advertisement.
3. **Project Location** - Enter the project location as it appears on the project advertisement.
4. **Project Description** - Enter the project description as it appears on the project advertisement (Bridge Rehab, Seismic Rehab, Overlay, Widening, etc.).
5. **Consultant's Name** - Enter the consultant's firm name.
6. **Prime Certified DBE** - Check box if prime contractor is a certified DBE.
7. **Description of Work, Services, or Materials Supplied** - Enter description of work, services, or materials to be provided. Indicate all work to be performed by DBEs including work performed by the prime consultant's own forces, if the prime is a DBE. If 100% of the item is not to be performed or furnished by the DBE, describe the exact portion to be performed or furnished by the DBE. See LAPM Chapter 9 to determine how to count the participation of DBE firms.
8. **DBE Certification Number** - Enter the DBE's Certification Identification Number. All DBEs must be certified on the date bids are opened.
9. **DBE Contact Information** - Enter the name, address, and phone number of all DBE subcontracted consultants. Also, enter the prime consultant's name and phone number, if the prime is a DBE.
10. **DBE %** - Percent participation of work to be performed or service provided by a DBE. Include the prime consultant if the prime is a DBE. See LAPM Chapter 9 for how to count full/partial participation.
11. **Total Claimed DBE Participation %** - Enter the total DBE participation claimed. If the total % claimed is less than item "Contract DBE Goal," an adequately documented Good Faith Effort (GFE) is required (see Exhibit 15-H DBE Information - Good Faith Efforts of the LAPM).
12. **Preparer's Signature** - The person completing the DBE commitment form on behalf of the consultant's firm must sign their name.
13. **Date** - Enter the date the DBE commitment form is signed by the consultant's preparer.
14. **Preparer's Name** - Enter the name of the person preparing and signing the consultant's DBE commitment form.
15. **Phone** - Enter the area code and phone number of the person signing the consultant's DBE commitment form.
16. **Preparer's Title** - Enter the position/title of the person signing the consultant's DBE commitment form.

LOCAL AGENCY SECTION

17. **Local Agency Contract Number** - Enter the Local Agency contract number or identifier.
18. **Federal-Aid Project Number** - Enter the Federal-Aid Project Number.
19. **Proposed Contract Execution Date** - Enter the proposed contract execution date.
20. **Consultant's Ranking after Evaluation** - Enter consultant's ranking after all submittals/consultants are evaluated. Use this as a quick comparison for evaluating most qualified consultant.
21. **Local Agency Representative's Signature** - The person completing this section of the form for the Local Agency must sign their name to certify that the information in this and the Consultant Section of this form is complete and accurate.
22. **Date** - Enter the date the DBE commitment form is signed by the Local Agency Representative.
23. **Local Agency Representative's Name** - Enter the name of the Local Agency Representative certifying the consultant's DBE commitment form.
24. **Phone** - Enter the area code and phone number of the person signing the consultant's DBE commitment form.
25. **Local Agency Representative Title** - Enter the position/title of the Local Agency Representative certifying the consultant's DBE commitment form.

EXHIBIT 10-02 CONSULTANT CONTRACT DBE COMMITMENT

1. Local Agency: _____ 2. Contract DBE Goal: _____
 3. Project Description: _____
 4. Project Location: _____
 5. Consultant's Name: _____ 6. Prime Certified DBE: 7. Total Contract Award Amount: _____
 8. Total Dollar Amount for ALL Subconsultants: _____ 9. Total Number of ALL Subconsultants: _____

10. Description of Work, Service, or Materials Supplied	11. DBE Certification Number	12. DBE Contact Information	13. DBE Dollar Amount
Local Agency to Complete this Section			\$
20. Local Agency Contract Number: _____ 21. Federal-Aid Project Number: _____ 22. Contract Execution Date: _____	14. TOTAL CLAIMED DBE PARTICIPATION		%
Local Agency certifies that all DBE certifications are valid and information on this form is complete and accurate.			IMPORTANT: Identify all DBE firms being claimed for credit, regardless of tier. Written confirmation of each listed DBE is required.
23. Local Agency Representative's Signature _____ 24. Date _____	15. Preparer's Signature _____ 16. Date _____		
25. Local Agency Representative's Name _____ 26. Phone _____	17. Preparer's Name _____ 18. Phone _____		
27. Local Agency Representative's Title _____	19. Preparer's Title _____		

DISTRIBUTION: 1. Original – Local Agency
 2. Copy – Caltrans District Local Assistance Engineer (DLAE). Failure to submit to DLAE within 30 days of contract execution may result in de-obligation of federal funds on contract.

ADA Notice: For individuals with sensory disabilities, this document is available in alternate formats. For information call (916) 654-6410 or TDD (916) 654-3880 or write Records and Forms Management, 1120 N Street, MS-99, Sacramento, CA 95814.

INSTRUCTIONS – CONSULTANT CONTRACT DBE COMMITMENT**CONSULTANT SECTION**

1. **Local Agency** - Enter the name of the local or regional agency that is funding the contract.
2. **Contract DBE Goal** - Enter the contract DBE goal percentage as it appears on the project advertisement.
3. **Project Description** - Enter the project description as it appears on the project advertisement (Bridge Rehab, Seismic Rehab, Overlay, Widening, etc).
4. **Project Location** - Enter the project location as it appears on the project advertisement.
5. **Consultant's Name** - Enter the consultant's firm name.
6. **Prime Certified DBE** - Check box if prime contractor is a certified DBE.
7. **Total Contract Award Amount** - Enter the total contract award dollar amount for the prime consultant.
8. **Total Dollar Amount for ALL Subconsultants** - Enter the total dollar amount for all subcontracted consultants. SUM = (DBEs + all Non-DBEs). Do not include the prime consultant information in this count.
9. **Total number of ALL subconsultants** - Enter the total number of all subcontracted consultants. SUM = (DBEs + all Non-DBEs). Do not include the prime consultant information in this count.
10. **Description of Work, Services, or Materials Supplied** - Enter description of work, services, or materials to be provided. Indicate all work to be performed by DBEs including work performed by the prime consultant's own forces, if the prime is a DBE. If 100% of the item is not to be performed or furnished by the DBE, describe the exact portion to be performed or furnished by the DBE. See LAPM Chapter 9 to determine how to count the participation of DBE firms.
11. **DBE Certification Number** - Enter the DBE's Certification Identification Number. All DBEs must be certified on the date bids are opened.
12. **DBE Contact Information** - Enter the name, address, and phone number of all DBE subcontracted consultants. Also, enter the prime consultant's name and phone number, if the prime is a DBE.
13. **DBE Dollar Amount** - Enter the subcontracted dollar amount of the work to be performed or service to be provided. Include the prime consultant if the prime is a DBE. See LAPM Chapter 9 for how to count full/partial participation.
14. **Total Claimed DBE Participation - \$**: Enter the total dollar amounts entered in the "DBE Dollar Amount" column. **%**: Enter the total DBE participation claimed ("Total Participation Dollars Claimed" divided by item "Total Contract Award Amount"). If the total % claimed is less than item "Contract DBE Goal," an adequately documented Good Faith Effort (GFE) is required (see Exhibit 15-H DBE Information - Good Faith Efforts of the LAPM).
15. **Preparer's Signature** - The person completing the DBE commitment form on behalf of the consultant's firm must sign their name.
16. **Date** - Enter the date the DBE commitment form is signed by the consultant's preparer.
17. **Preparer's Name** - Enter the name of the person preparing and signing the consultant's DBE commitment form.
18. **Phone** - Enter the area code and phone number of the person signing the consultant's DBE commitment form.
19. **Preparer's Title** - Enter the position/title of the person signing the consultant's DBE commitment form.

LOCAL AGENCY SECTION

20. **Local Agency Contract Number** - Enter the Local Agency contract number or identifier.
21. **Federal-Aid Project Number** - Enter the Federal-Aid Project Number.
22. **Contract Execution Date** - Enter the date the contract was executed.
23. **Local Agency Representative's Signature** - The person completing this section of the form for the Local Agency must sign their name to certify that the information in this and the Consultant Section of this form is complete and accurate.
24. **Date** - Enter the date the DBE commitment form is signed by the Local Agency Representative.
25. **Local Agency Representative's Name** - Enter the name of the Local Agency Representative certifying the consultant's DBE commitment form.
26. **Phone** - Enter the area code and phone number of the person signing the consultant's DBE commitment form.
27. **Local Agency Representative Title** - Enter the position/title of the Local Agency Representative certifying the consultant's DBE commitment form.

EXHIBIT 10-Q DISCLOSURE OF LOBBYING ACTIVITIES

COMPLETE THIS FORM TO DISCLOSE LOBBYING ACTIVITIES PURSUANT TO 31 U.S.C. 1352

<p>1. Type of Federal Action:</p> <p><input type="checkbox"/> a. contract <input type="checkbox"/> b. grant <input type="checkbox"/> c. cooperative agreement <input type="checkbox"/> d. loan <input type="checkbox"/> e. loan guarantee <input type="checkbox"/> f. loan insurance</p>	<p>2. Status of Federal Action:</p> <p><input type="checkbox"/> a. bid/offer/application <input type="checkbox"/> b. initial award <input type="checkbox"/> c. post-award</p>	<p>3. Report Type:</p> <p><input type="checkbox"/> a. initial <input type="checkbox"/> b. material change</p> <p>For Material Change Only: year _____ quarter _____ date of last report _____</p>
<p>4. Name and Address of Reporting Entity</p> <p><input type="checkbox"/> Prime <input type="checkbox"/> Subawardee Tier _____, if known</p> <p>Congressional District, if known _____</p>	<p>5. If Reporting Entity in No. 4 is Subawardee, Enter Name and Address of Prime:</p> <p>Congressional District, if known _____</p>	
<p>6. Federal Department/Agency:</p>	<p>7. Federal Program Name/Description:</p> <p>CFDA Number, if applicable _____</p>	
<p>8. Federal Action Number, if known:</p>	<p>9. Award Amount, if known:</p>	
<p>10. Name and Address of Lobby Entity (If individual, last name, first name, MI)</p>	<p>11. Individuals Performing Services (including address if different from No. 10) (last name, first name, MI)</p>	
<p>(attach Continuation Sheet(s) if necessary)</p>		
<p>12. Amount of Payment (check all that apply)</p> <p>\$ _____ <input type="checkbox"/> actual <input type="checkbox"/> planned</p>	<p>14. Type of Payment (check all that apply)</p> <p><input type="checkbox"/> a. retainer <input type="checkbox"/> b. one-time fee <input type="checkbox"/> c. commission <input type="checkbox"/> d. contingent fee <input type="checkbox"/> e. deferred <input type="checkbox"/> f. other, specify _____</p>	
<p>13. Form of Payment (check all that apply):</p> <p><input type="checkbox"/> a. cash <input type="checkbox"/> b. in-kind; specify: nature _____ Value _____</p>		
<p>15. Brief Description of Services Performed or to be performed and Date(s) of Service, including officer(s), employee(s), or member(s) contacted, for Payment Indicated in Item 12:</p> <p>(attach Continuation Sheet(s) if necessary)</p>		
<p>16. Continuation Sheet(s) attached: Yes <input type="checkbox"/> No <input type="checkbox"/></p>		
<p>17. Information requested through this form is authorized by Title 31 U.S.C. Section 1352. This disclosure of lobbying reliance was placed by the tier above when his transaction was made or entered into. This disclosure is required pursuant to 31 U.S.C. 1352. This information will be reported to Congress semiannually and will be available for public inspection. Any person who fails to file the required disclosure shall be subject to a civil penalty of not less than \$10,000 and not more than \$100,000 for each such failure.</p>		
		<p>Signature: _____ Print Name: _____ Title: _____ Telephone No.: _____ Date: _____</p>
<p>Federal Use Only:</p>		<p>Authorized for Local Reproduction Standard Form - LLL</p>

Standard Form LLL Rev. 04-28-06

Distribution: Orig- Local Agency Project Files

INSTRUCTIONS FOR COMPLETING EXHIBIT 10-Q DISCLOSURE OF LOBBYING ACTIVITIES

This disclosure form shall be completed by the reporting entity, whether subawardee or prime federal recipient at the initiation or receipt of covered federal action or a material change to previous filing pursuant to title 31 U.S.C. Section 1352. The filing of a form is required for such payment or agreement to make payment to lobbying entity for influencing or attempting to influence an officer or employee of any agency, a Member of Congress an officer or employee of Congress or an employee of a Member of Congress in connection with a covered federal action. Attach a continuation sheet for additional information if the space on the form is inadequate. Complete all items that apply for both the initial filing and material change report. Refer to the implementing guidance published by the Office of Management and Budget for additional information.

1. Identify the type of covered federal action for which lobbying activity is or has been secured to influence, the outcome of a covered federal action.
2. Identify the status of the covered federal action.
3. Identify the appropriate classification of this report. If this is a follow-up report caused by a material change to the information previously reported, enter the year and quarter in which the change occurred. Enter the date of the last, previously submitted report by this reporting entity for this covered federal action.
4. Enter the full name, address, city, state, and zip code of the reporting entity. Include Congressional District if known. Check the appropriate classification of the reporting entity that designates if it is or expects to be a prime or subaward recipient. Identify the tier of the subawardee, e.g., the first subawardee of the prime is the first tier. Subawards include but are not limited to: subcontracts, subgrants, and contract awards under grants.
5. If the organization filing the report in Item 4 checks "Subawardee" then enter the full name, address, city, state, and zip code of the prime federal recipient. Include Congressional District, if known.
6. Enter the name of the federal agency making the award or loan commitment. Include at least one organization level below agency name, if known. For example, Department of Transportation, United States Coast Guard.
7. Enter the federal program name or description for the covered federal action (item 1). If known, enter the full Catalog of Federal Domestic Assistance (CFDA) number for grants, cooperative agreements, loans and loan commitments.
8. Enter the most appropriate federal identifying number available for the federal action identification in item 1 (e.g., Request for Proposal (RFP) number, Invitation for Bid (IFB) number, grant announcement number, the contract grant, or loan award number, the application/proposal control number assigned by the federal agency). Include prefixes, e.g., "RFP-DE-90-001 "
9. For a covered federal action where there has been an award or loan commitment by the Federal agency, enter the federal amount of the award/loan commitments for the prime entity identified in item 4 or 5.
10. Enter the full name, address, city, state, and zip code of the lobbying entity engaged by the reporting entity identified in Item 4 to influence the covered federal action.
11. Enter the full names of the individual(s) performing services and include full address if different from 10 (a). Enter Last Name, First Name and Middle Initial (MI).
12. Enter the amount of compensation paid or reasonably expected to be paid by the reporting entity (Item 4) to the lobbying entity (Item 10). Indicate whether the payment has been made (actual) or will be made (planned). Check all boxes that apply. If this is a material change report, enter the cumulative amount of payment made or planned to be made.
13. Check all boxes that apply. If payment is made through an in-kind contribution, specify the nature and value of the in-kind payment.
14. Check all boxes that apply. If other, specify nature.
15. Provide a specific and detailed description of the services that the lobbyist has performed or will be expected to perform and the date(s) of any services rendered. Include all preparatory and related activity not just time spent in actual contact with federal officials. Identify the federal officer(s) or employee(s) contacted or the officer(s) employee(s) or Member(s) of Congress that were contacted.
16. Check whether or not a continuation sheet(s) is attached.
17. The certifying official shall sign and date the form, and print his/her name title and telephone number.

Public reporting burden for this collection of information is estimated to average 30-minutes per response, including time for reviewing instruction, searching existing data sources, gathering and maintaining the data needed, and completing and reviewing the collection of information. Send comments regarding the burden estimate or any other aspect of this collection of information, including suggestions for reducing this burden, to the Office of Management and Budget, Paperwork Reduction Project (0348-0046), Washington, D.C. 20503. SF-LLL-Instructions Rev: 06-04

EXHIBIT 15-H: PROPOSER/CONTRACTOR GOOD FAITH EFFORTS

Federal-aid Project No(s). _____ Cost Proposal Due Date _____ PE/CE
Bid Opening Date _____ CON

The _____ (Agency Name) _____ established a Disadvantaged Business Enterprise (DBE) goal of _____% for this contract. The information provided herein shows the required good faith efforts to meet or exceed the DBE contract goal.

Proposers or bidders submit the following information to document their good faith efforts within five (5) calendar days from cost proposal due date or bid opening. Proposers and bidders are recommended to submit the following information even if the Exhibit 10-O1: Consultant Proposal DBE Commitments or Exhibit 15-G: Construction Contract DBE Commitment indicate that the proposer or bidder has met the DBE goal. This form protects the proposer's or bidder's eligibility for award of the contract if the administering agency determines that the bidder failed to meet the goal for various reasons, e.g., a DBE firm was not certified at bid opening, or the bidder made a mathematical error.

The following items are listed in the Section entitled "Submission of DBE Commitment" of the Special Provisions, **please attach additional sheets as needed:**

- A. The names and dates of each publication in which a request for DBE participation for this project was placed by the bidder (please attach copies of advertisements or proofs of publication):

Publications	Dates of Advertisement

- B. The names and dates of written notices sent to certified DBEs soliciting bids for this project and the dates and methods used for following up initial solicitations to determine with certainty whether the DBEs were interested (please attach copies of solicitations, telephone records, fax confirmations, etc.):

Names of DBEs Solicited	Date of Initial Solicitation	Follow Up Methods and Dates

Local Assistance Procedures Manual

- C. The items of work made available to DBE firms including those unbundled contract work items into economically feasible units to facilitate DBE participation. It is the bidder's responsibility to demonstrate that sufficient work to facilitate DBE participation in order to meet or exceed the DBE contract goal.

Items of Work	Proposer or Bidder Normally Performs Item (Y/N)	Breakdown of Items	Amount (\$)	Percentage Of Contract
				0.00%
				0.00%
				0.00%
				0.00%

- D. The names, addresses and phone numbers of rejected DBE firms, the reasons for the bidder's rejection of the DBEs, the firms selected for that work (please attach copies of quotes from the firms involved), and the price difference for each DBE if the selected firm is not a DBE:

Names, addresses and phone numbers of rejected DBEs and the reasons for the bidder's rejection of the DBEs:

Names, addresses and phone numbers of firms selected for the work above:

- E. Efforts (e.g. in advertisements and solicitations) made to assist interested DBEs in obtaining information related to the plans, specifications and requirements for the work which was provided to DBEs:

Local Assistance Procedures Manual

F. Efforts (e.g. in advertisements and solicitations) made to assist interested DBEs in obtaining bonding, lines of credit or insurance, necessary equipment, supplies, materials, or related assistance or services, excluding supplies and equipment the DBE subcontractor purchases or leases from the prime contractor or its affiliate:

G. The names of agencies, organizations or groups contacted to provide assistance in contacting, recruiting and using DBE firms (please attach copies of requests to agencies and any responses received, i.e., lists, Internet page download, etc.):

Name of Agency/Organization	Method/Date of Contact	Results
_____	_____	_____
_____	_____	_____
_____	_____	_____
_____	_____	_____
_____	_____	_____

H. Any additional data to support a demonstration of good faith efforts:

APPENDIX IV: EXHIBIT 10-H2 COST PROPOSAL

EXHIBIT 10-H2 COST PROPOSAL Page 1 of 3

SPECIFIC RATE OF COMPENSATION (USE FOR ON-CALL OR AS-NEEDED CONTRACTS)
(CONSTRUCTION ENGINEERING AND INSPECTION CONTRACTS)

Note: Mark-ups are Not Allowed

Consultant _____ Prime Consultant Subconsultant 2nd Tier Subconsultant

Project No. _____ Contract No. _____ Participation Amount \$ _____ Date _____

For Combined Rate	Fringe Benefit % + General & Administrative %	=	Combined ICR%
	OR		
For Home Office Rate	Fringe Benefit % + General & Administrative %	=	Home Office ICR%
For Field Office Rate	Fringe Benefit % + General & Administrative %	=	Field Office ICR%
	Fee	=	%

BILLING INFORMATION

CALCULATION INFORMATION

Name/Job Title/Classification ¹	Hourly Billing Rates ²			Effective Date of Hourly Rate		Actual or Avg. Hourly Rate ⁴	% or \$ Increase	Hourly Range - for Classifications Only
	Straight ³	OT(1.5x)	OT(2x)	From	To			
John Doe – Project Manager * Civil Engineer II	\$0.00	\$0.00	\$0.00	01/01/2016	12/31/2016	\$0.00		Not Applicable
	\$0.00	\$0.00	\$0.00	01/01/2017	12/31/2017	\$0.00	0.0%	
	\$0.00	\$0.00	\$0.00	01/01/2018	12/31/2018	\$0.00	0.0%	
Sue Jones – Construction Engineer/Inspector Engineer I	\$0.00	\$0.00	\$0.00	01/01/2016	12/31/2016	\$0.00		Not Applicable
	\$0.00	\$0.00	\$0.00	01/01/2017	12/31/2017	\$0.00	0.0%	
	\$0.00	\$0.00	\$0.00	01/01/2018	12/31/2018	\$0.00	0.0%	
Buddy Black – Claims Engineer Engineer III	\$0.00	\$0.00	\$0.00	01/01/2016	12/31/2016	\$0.00		Not Applicable
	\$0.00	\$0.00	\$0.00	01/01/2017	12/31/2017	\$0.00	0.0%	
	\$0.00	\$0.00	\$0.00	01/01/2018	12/31/2018	\$0.00	0.0%	
Land Surveyor **	\$0.00	\$0.00	\$0.00	01/01/2016	12/31/2016	\$0.00		\$00 - \$00
	\$0.00	\$0.00	\$0.00	01/01/2017	12/31/2017	\$0.00	0.0%	\$00 - \$00
	\$0.00	\$0.00	\$0.00	01/01/2018	12/31/2018	\$0.00	0.0%	\$00 - \$00
Technician	\$0.00	\$0.00	\$0.00	01/01/2016	12/31/2016	\$0.00		\$00 - \$00
	\$0.00	\$0.00	\$0.00	01/01/2017	12/31/2017	\$0.00	0.0%	\$00 - \$00
	\$0.00	\$0.00	\$0.00	01/01/2018	12/31/2018	\$0.00	0.0%	\$00 - \$00

(Add pages as necessary)

NOTES:

1. Key personnel must be marked with an asterisk (*) and employees that are subject to prevailing wage requirements must be marked with two asterisks (**). All costs must comply with the Federal cost principles. Subconsultants will provide their own cost proposals.
2. The cost proposal format shall not be amended.
3. Billing rate = actual hourly rate * (1+ ICR) * (1+ Fee). Indirect cost rates shall be updated on an annual basis in accordance with the consultant's annual accounting period and established by a cognizant agency or accepted by Caltrans. All costs must comply with the Federal cost principles for reimbursement.
4. For named employees and key personnel enter the actual hourly rate. For classifications only, enter the Average Hourly Rate for that classification.

EXHIBIT 10-H2 COST PROPOSAL Page 2 of 3

SPECIFIC RATE OF COMPENSATION (USE FOR ON-CALL OR AS-NEEDED CONTRACTS)
(CONSTRUCTION ENGINEERING AND INSPECTION CONTRACTS)

Consultant _____ Prime Consultant Subconsultant

Project No. _____ Contract No. _____ Date _____

SCHEDULE OF OTHER DIRECT COST ITEMS (Add additional pages as necessary)				
Description of Item	Quantity	Unit	Unit Cost	Total
Vehicle				\$ 0.00
Subconsultant 1:				
Subconsultant 2:				
Subconsultant 3:				
Subconsultant 4:				
Subconsultant 5:				

Note: Add additional pages if necessary.

NOTES:

1. List other direct cost items with estimated costs. These costs should be competitive in their respective industries and supported with appropriate documentation.
2. Proposed ODC items should be consistently billed regardless of client and contract type.
3. Items when incurred for the same purpose, in like circumstance, should not be included in any indirect cost pool or in the overhead rate.
4. Items such as special tooling, will be reimbursed at actual cost with supporting documentation (invoice).
5. Items listed above that would be considered "tools of the trade" are not reimbursable as other direct cost.
6. Travel related costs should be pre-approved by the contracting agency and shall not exceed current State Department of Personnel Administration rules.

7. If mileage is claimed, the rate should be properly supported by the consultant's calculation of their actual costs for company vehicles. In addition, the miles claimed should be supported by mileage logs.
8. If a consultant proposes rental costs for a vehicle, the company must demonstrate that this is its standard procedure for all of their contracts and that they do not own any vehicles that could be used for the same purpose.
9. The cost proposal format shall not be amended. All costs must comply with the Federal cost principles.
10. Add additional pages if necessary.
11. Subconsultants must provide their own cost proposals.

APPENDIX V: PROJECT PLANS AND SPECIFICATIONS

SHEET NUMBER	TOTAL SHEETS
1	23

COUNTY OF MONTEREY

PROJECT PLANS FOR THE CONSTRUCTION OF THE

ROBINSON CANYON ROAD BRIDGE

SCOUR COUNTERMEASURE PROJECT

(BR. NO. 44C-0017)

COUNTY PROJECT No. 385165

SHEET INDEX:

SHEET No.	TITLE
1	TITLE SHEET
B-1	BRIDGE GENERAL PLAN
B-2	FOUNDATION PLAN
B-3	SCOUR PROTECTION DETAILS NO. 1
B-4	SCOUR PROTECTION DETAILS NO. 2
B-5	ARTICULATED CONCRETE BLOCK (ACB) MAT
C-1 TO C-3	CONSTRUCTION DETAILS
G-1	GRADING PLAN
U-1	UTILITY PLAN
TR-1	TREE REMOVAL PLAN
P-1 TO P-11	PLANTING PLANS

GENERAL NOTES:

1. THE CONTRACTOR SHALL POSSESS THE CLASS (OR CLASSES) OF LICENSE AS SPECIFIED IN THE "NOTICE TO BIDDERS".
2. TO BE SUPPLEMENTED BY THE 2018 CALTRANS STANDARD SPECIFICATIONS AND STANDARD PLANS, INCLUDING ISSUED ADDENDA.
3. CONTRACTOR SHALL NOTIFY THE COUNTY OF MONTEREY OF ANY AND ALL CONFLICTS BETWEEN THIS SET OF CONSTRUCTION DRAWINGS AND THE ACTUAL SITE CONDITIONS PRIOR TO COMMENCING WORK. CONTACT ENGINEER AT (831) 755-4800.
4. CONTRACTOR SHALL NOTIFY THE COUNTY OF MONTEREY (ENGINEER) AT LEAST 8 DAYS PRIOR TO COMMENCING WORK SO THAT THE COUNTY MAY PRESERVE MONUMENTS AND BENCHMARKS, WHICH SHALL NOT BE DISTURBED WITHOUT THE COUNTY'S CONSENT. THE CONTRACTOR SHALL BE RESPONSIBLE FOR REPLACING DESTROYED BENCHMARKS.
5. CONTRACTOR SHALL EXPOSE ALL EXISTING UNDERGROUND PIPELINES OR OTHER UNDERGROUND OBSTRUCTIONS TO VERIFY THAT THERE ARE NO GRADE CONFLICTS PRIOR TO LAYING ANY GRAVITY PIPELINES.
6. WHERE UNDERGROUND AND SURFACE STRUCTURES ARE SHOWN ON THIS SET OF DRAWINGS, THE LOCATIONS, DEPTH, AND DIMENSIONS OF STRUCTURES ARE BELIEVED TO BE REASONABLY CORRECT, BUT ARE NOT GUARANTEED. THE INFORMATION SO GIVEN IS NOT TO BE CONSTRUED AS A REPRESENTATION THAT SUCH STRUCTURES WILL, IN ALL CASES, BE FOUND WHERE SHOWN, OR THAT THEY REPRESENT ALL THE STRUCTURES WHICH MAY BE ENCOUNTERED.
7. CONTRACTOR AGREES THAT IN ACCORDANCE WITH GENERALLY ACCEPTED CONSTRUCTION PRACTICES, CONTRACTOR WILL BE REQUIRED TO ASSUME SOLE AND COMPLETE RESPONSIBILITY FOR THE JOB SITE CONDITIONS DURING CONSTRUCTION, INCLUDING SAFETY OF ALL PERSONS AND PROPERTY, THIS REQUIREMENT SHALL BE MADE TO APPLY CONTINUOUSLY AND NOT BE LIMITED TO NORMAL WORKING HOURS.

ABBREVIATIONS:

- PVI - POINT OF VERTICAL INTERSECTION
 LVC - LENGTH OF VERTICAL CURVE

BENCHMARK:

STANDARD PLANS:

2018 CALTRANS STANDARD PLANS

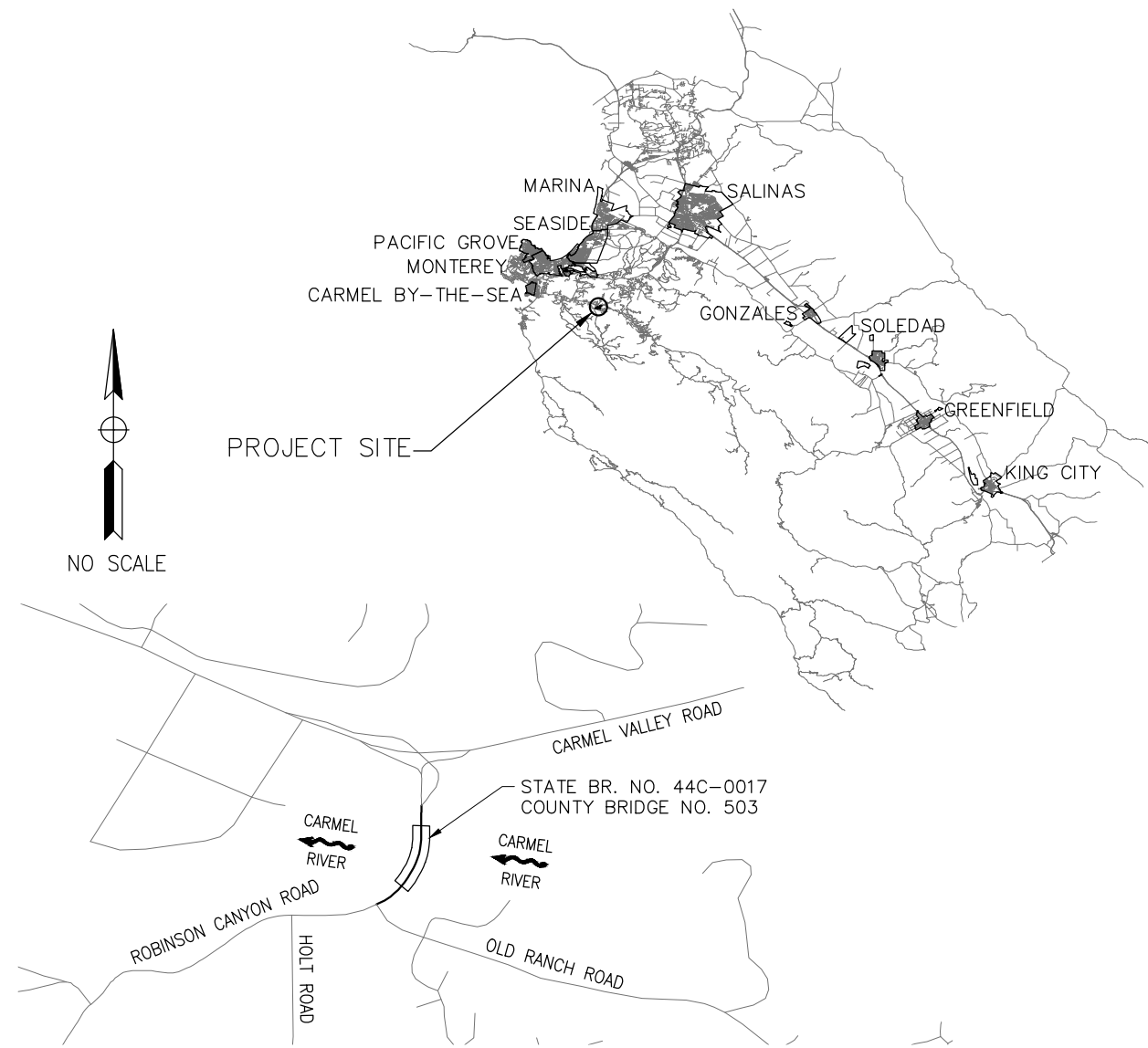

VICINITY MAP
NTS

UTILITY CONTACTS:

- | | |
|--|---|
| PG&E
401 WORK STREET
SALINAS, CA 93901
CHARLES STRONG - GAS
(831) 784-3642
SANDY CARILLO - ELECTRIC
(831) 784-3427 | COMCAST
106 WHISPERING PINES DRIVE
SCOTTS VALLEY, CA 95066
MARK GIBLIN
(831) 440-4023 |
| AT&T
515 CHAPPEL ROAD
WATSONVILLE, CA 95076
SUE BARRAZA
(831) 728-6571 | CALIFORNIA WATER SERVICE COMPANY
254 COMMISSION STREET
SALINAS, CA 93901
MIKE JONES |



UNDERGROUND FACILITIES SHOWN WERE LOCATED BASED ON INFORMATION PROVIDED BY UTILITY COMPANIES AND BY MEASURING SURFACE FEATURES.

CONTRACTOR SHALL VERIFY ACTUAL DEPTH AND LOCATION OF ALL EXISTING UTILITIES PRIOR TO CONSTRUCTION...CALL "UNDERGROUND SERVICE ALERT" (U.S.A), (TOLL FREE 811) PRIOR TO TRENCHING, GRADING, EXCAVATION, DRILLING, PIPE PUSHING, PLANTING TREES, DIGGING POST HOLES FOR FENCE, ETC.(U.S.A) WILL SUPPLY INFORMATION OR LOCATE AND MARK ANY UNDERGROUND FACILITIES.

APPENDIX V- PROJECT PLANS, SPECIFICATIONS AND ESTIMATE

Submitted by: M. IMBRIANI Design Engineer C.E. No. 36634	
DESIGN BY: A. BEDAL	CHKD BY: J. CONKLIN
DRAWN BY: A. BEDAL	CHKD BY: J. CONKLIN
SPECIFICATIONS WRITTEN BY: J. CONKLIN	CHKD BY: M. IMBRIANI
Approval Recommended by: _____ Deputy Public Works Director, Engineering	

TRC

10680 White Rock Rd., Suite 100
Rancho Cordova, California 95670

ORIGINAL SCALE IN INCHES FOR REDUCED PLANS

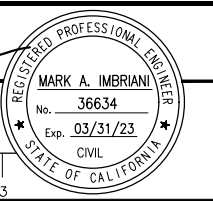

NO.	DATE	REVISION DESCRIPTION	APPROVED

COUNTY OF MONTEREY
DEPT. OF PUBLIC WORKS,
FACILITIES & PARKS

1441 SCHILLING PLACE
SALINAS, CALIFORNIA 93901
(831) 755-4800/FAX (831) 755-4958

ROBINSON CANYON ROAD BRIDGE SCOUR COUNTERMEASURE PROJECT TITLE SHEET			
STATE NO. 44C0017, BHL0-5944(099), COUNTY NO. 503			
DATE 09-10-21	FILE	PROJECT NO. 385165	SHEET 1
SCALE NTS		CONTRACT NO.	
			OF 23 SHEETS

Drawing name: I:\262649 Robinson Canyon Road Bridge\Sheets\TITLE - SHEET.dwg Layout: I:\262649 Robinson Canyon Road Bridge\Sheets\TITLE - SHEET.dwg - 12/01/2021 11:12:01 am gimbisen

APPENDIX V- PROJECT PLANS, SPECIFICATIONS AND ESTIMATE

SHEET NUMBER	TOTAL SHEETS
2	23

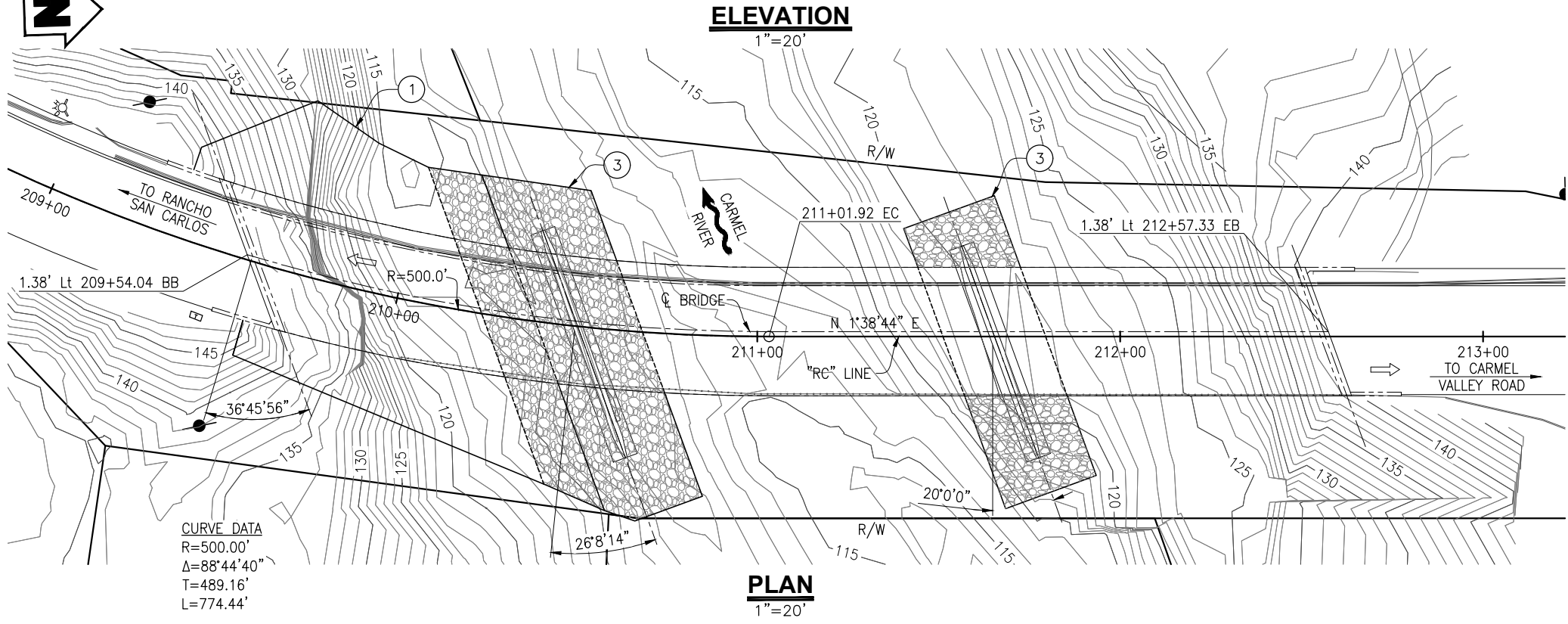
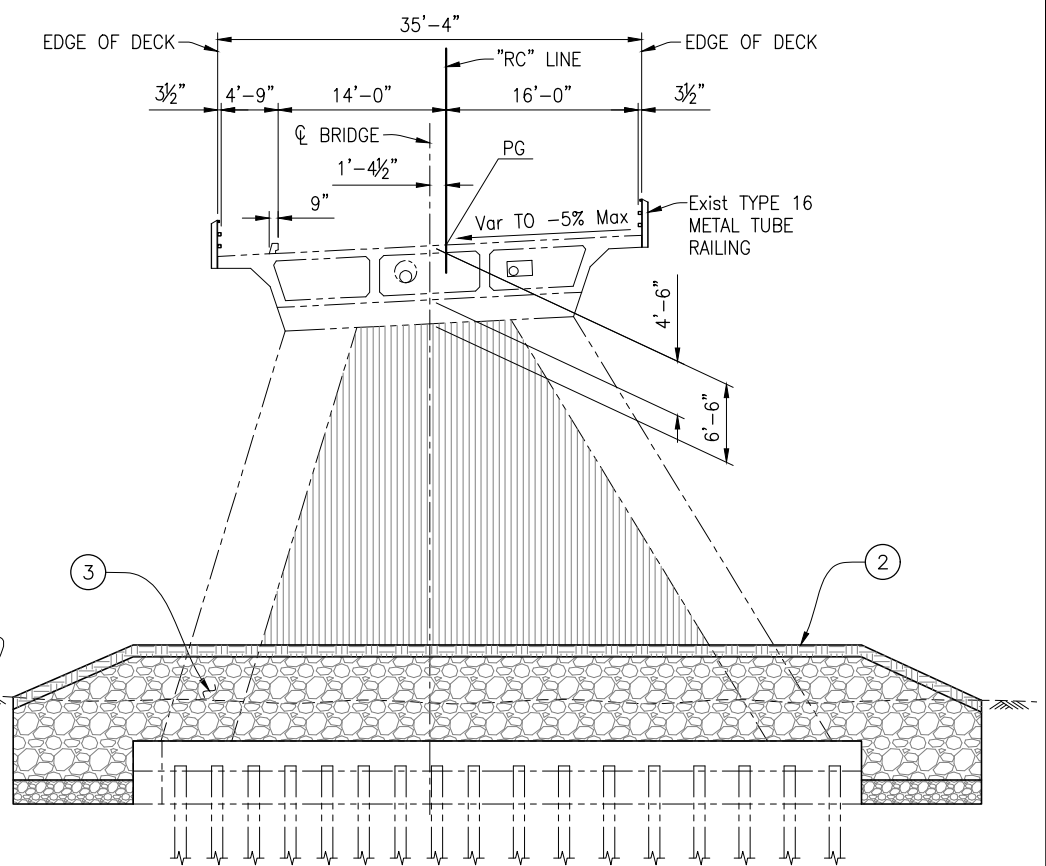
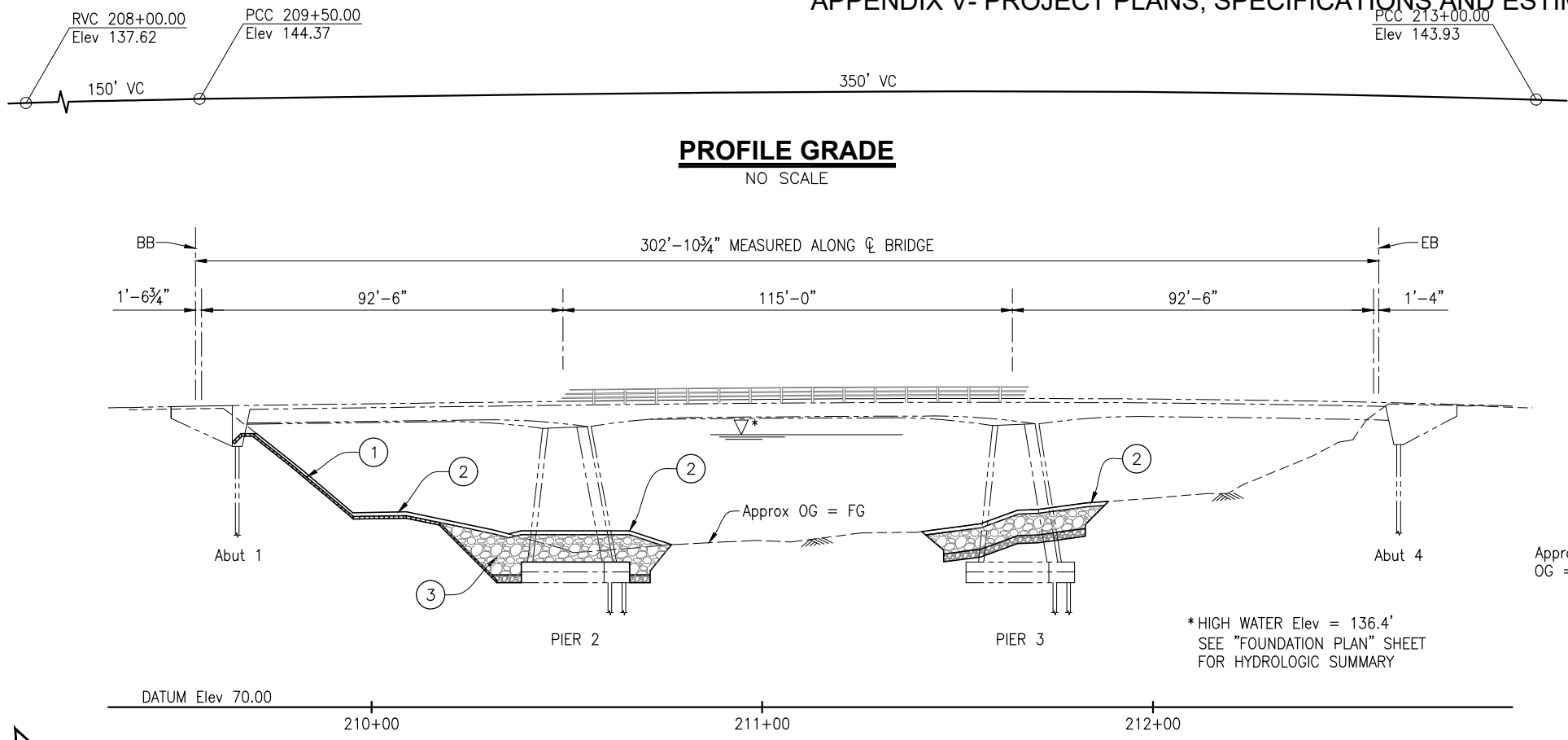

LEGEND:

- Indicates Existing Structure
- ~ Indicates Direction of Flow
- ← Indicates Direction of Traffic
- ① Articulated Concrete Block (ACB) Mat
- ② Native Material Over RSP and ACB, Typ
- ③ Rock Slope Protection (RSP)

NOTE:

1. All dimensions shown are ±.

Submitted by: M. IMBRIANI Design Engineer C.E. No. 36634	
DESIGN BY: G. ANGEL	CHKD BY: C. PINKERTON
DRAWN BY: A. BEDAL	CHKD BY: G. ANGEL
SPECIFICATIONS WRITTEN BY: J. CONKLIN	CHKD BY: M. IMBRIANI
Approval Recommended by: Deputy Public Works Director, Engineering	

TRC

10680 White Rock Rd., Suite 100
Rancho Cordova, California 95670

ORIGINAL SCALE IN INCHES FOR REDUCED PLANS

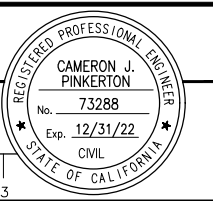

NO.	DATE	REVISION DESCRIPTION	APPROVED

COUNTY OF MONTEREY
DEPT. OF PUBLIC WORKS,
FACILITIES & PARKS

1441 SCHILLING PLACE
SALINAS, CALIFORNIA 93901
(831) 755-4800/FAX (831) 755-4958

ROBINSON CANYON ROAD BRIDGE SCOUR COUNTERMEASURE PROJECT GENERAL PLAN			
STATE NO. 44C0017, BHLO-5944(099), COUNTY NO. 503			
DATE 09-10-21	FILE	PROJECT NO. 385165	SHEET 2
SCALE AS NOTED		CONTRACT NO.	OF 23 SHEETS

B-1

APPENDIX V- PROJECT PLANS, SPECIFICATIONS AND ESTIMATE

SHEET NUMBER	TOTAL SHEETS
3	23

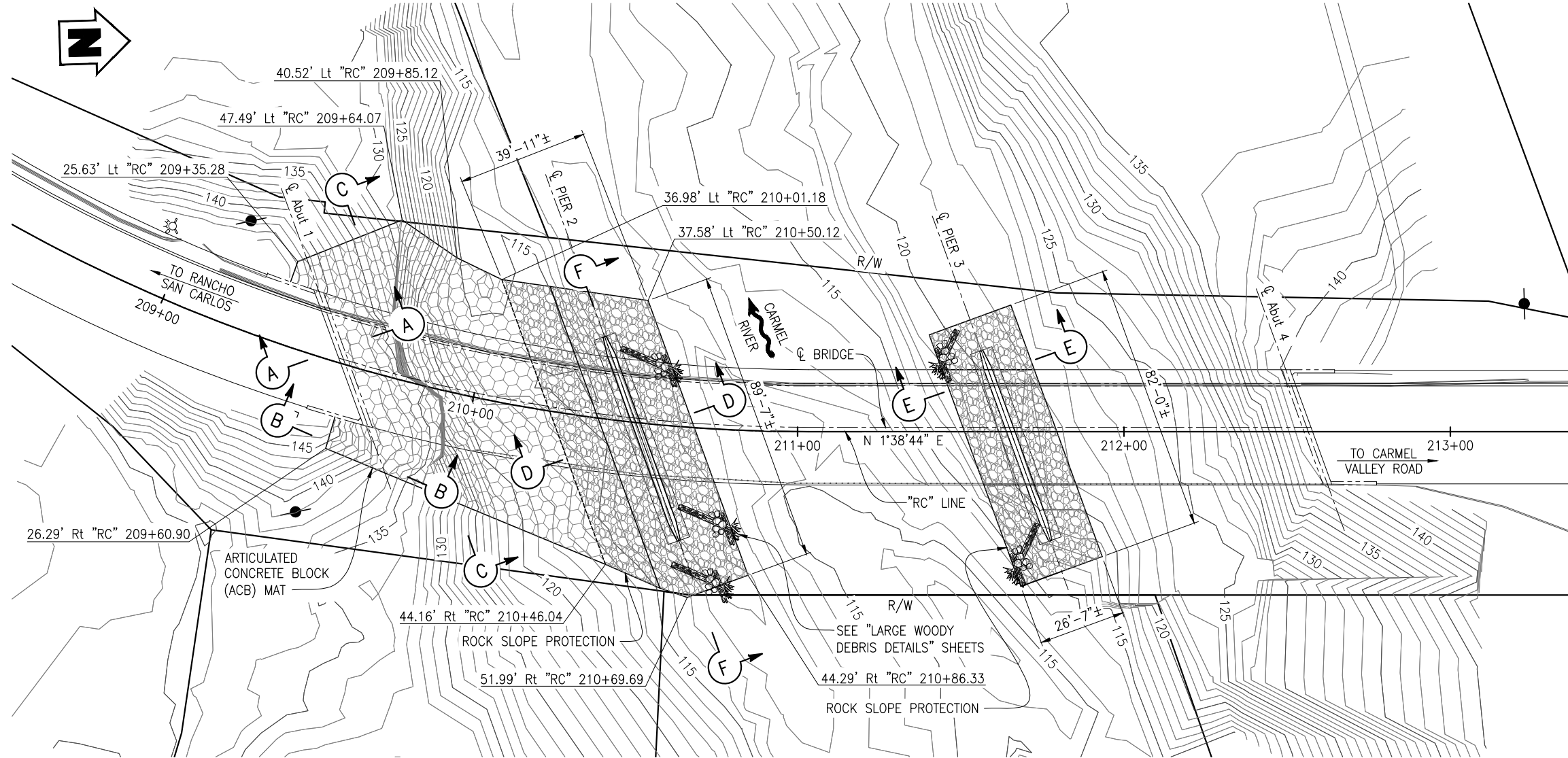

PLAN
1"=20'

HYDROLOGIC SUMMARY

Drainage Area:	220.5 Square Miles		
	Design Flood	Base Flood	Flood of Record
Frequency (Years)	50	100	N/A
Discharge (Cubic feet per second)	19,340	23,650	N/A
Water Surface (Elevation at Bridge)	135.0	136.4	N/A

Flood plain data are based upon information available when the plans were prepared and are shown to meet Federal requirements. The accuracy of said information is not warranted by Monterey County or TRC and interested or affected parties should make their own investigation.

SCOUR DATA TABLE

SUPPORT No.	LONG TERM (DEGRADATION AND CONTRACTION) SCOUR ELEVATION (FT)	SHORT TERM (LOCAL) SCOUR DEPTH (FT)
Abut 1	101.3	13.2
PIER 2	101.3	6.6
PIER 3	101.3	6.1
Abut 4	101.3	N/A

LEGEND:

- Indicates Existing Structure
- Indicates New Structure
- ~ Indicates Direction of Flow
- ← Indicates Direction of Traffic
- [Rock Pattern] Rock Slope Protection (1/2 Ton, Class VII Method B)
- [ACB Pattern] Articulated Concrete Block (ACB) Mat

NOTES:

1. For Sections A-A, B-B, and C-C, see "SCOUR PROTECTION DETAILS No.1" sheet.
2. For Sections D-D, E-E, and F-F, see "SCOUR PROTECTION DETAILS No.2" sheet.

B-2

Submitted by: M. IMBRIANI Design Engineer C.E. No. 36634	
DESIGN BY: G. ANGEL	CHKD BY: C. PINKERTON
DRAWN BY: A. BEDAL	CHKD BY: G. ANGEL
SPECIFICATIONS WRITTEN BY: J. CONKLIN	CHKD BY: M. IMBRIANI
Approval Recommended by: _____ Deputy Public Works Director, Engineering	

TRC

10680 White Rock Rd., Suite 100
Rancho Cordova, California 95670

ORIGINAL SCALE IN INCHES FOR REDUCED PLANS

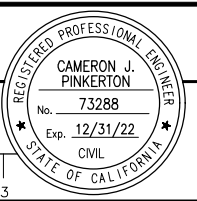

NO.	DATE	REVISION DESCRIPTION	APPROVED

COUNTY OF MONTEREY
DEPT. OF PUBLIC WORKS,
FACILITIES & PARKS

1441 SCHILLING PLACE
SALINAS, CALIFORNIA 93901
(831) 755-4800/FAX (831) 755-4958

ROBINSON CANYON ROAD BRIDGE SCOUR COUNTERMEASURE PROJECT FOUNDATION PLAN			
STATE NO. 44C0017, BHLO-5944(099), COUNTY NO. 503			
DATE 09-10-21	FILE	PROJECT NO. 385165	SHEET 3
SCALE AS NOTED		CONTRACT NO.	OF 23 SHEETS

Drawing name: H:\2649 Robinson Canyon Road Bridge\Structures\VP-01.dwg Layout Tab Layout1 Sep 28 2021 11:55am gmbse

SHEET NUMBER	TOTAL SHEETS
4	23

APPENDIX V- PROJECT PLANS, SPECIFICATIONS AND ESTIMATE

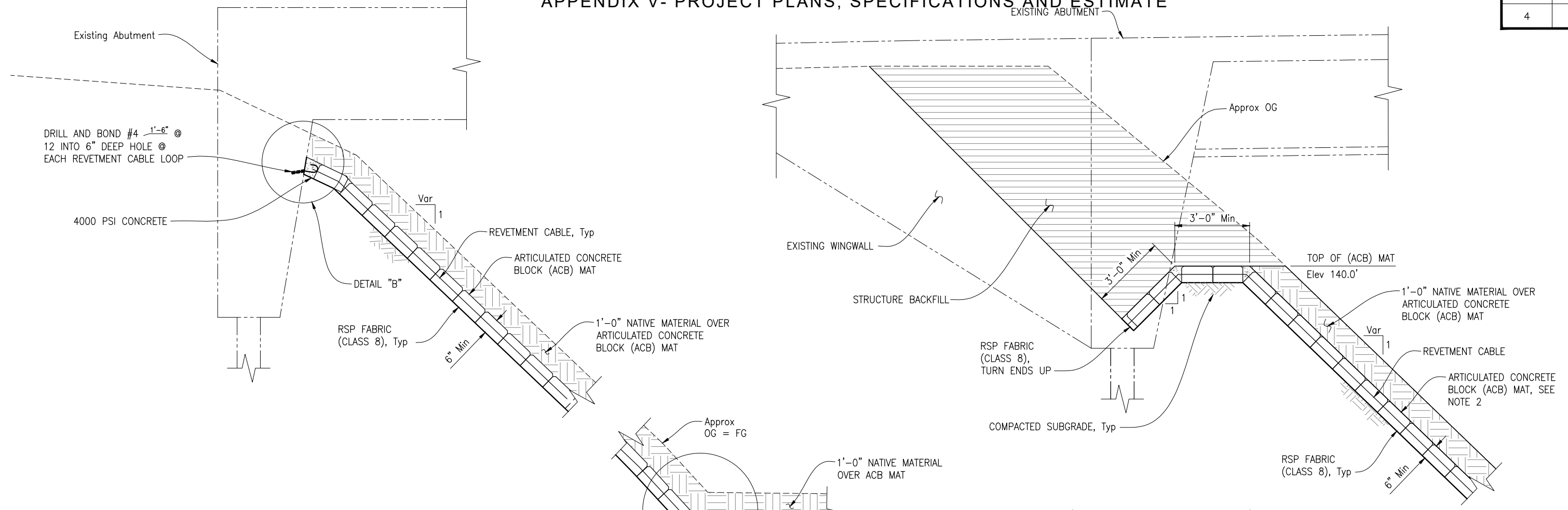

SECTION A-A
1/2"=1'-0"

(Abut 1 Rt SHOWN, Abut 1 Lt SIMILAR)
SECTION B-B
1/2"=1'-0"

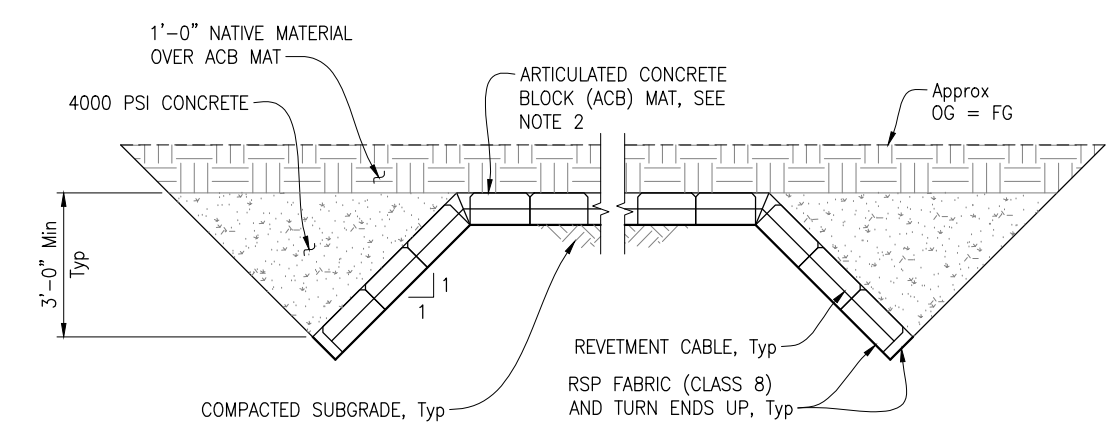

SECTION C-C
1/2"=1'-0"

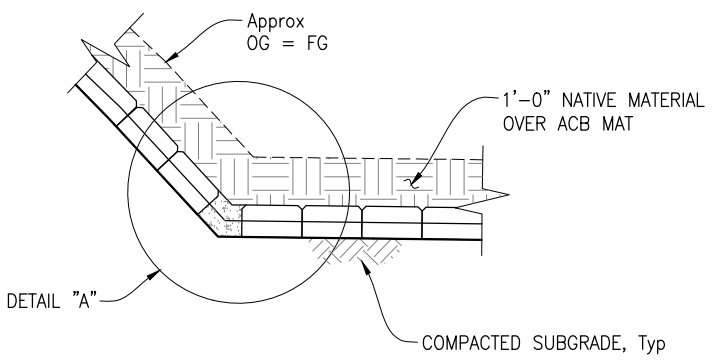

DETAIL "A"

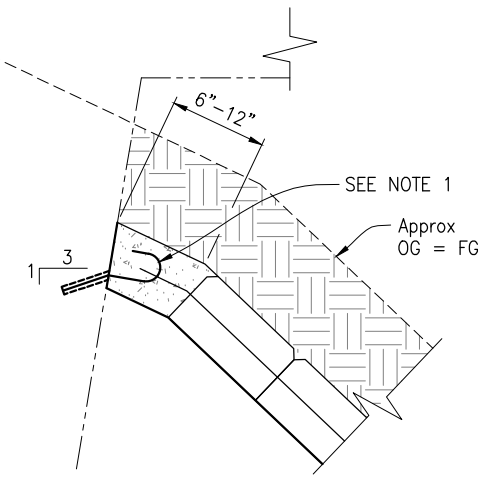

DETAIL "B"
1"=1'-0"

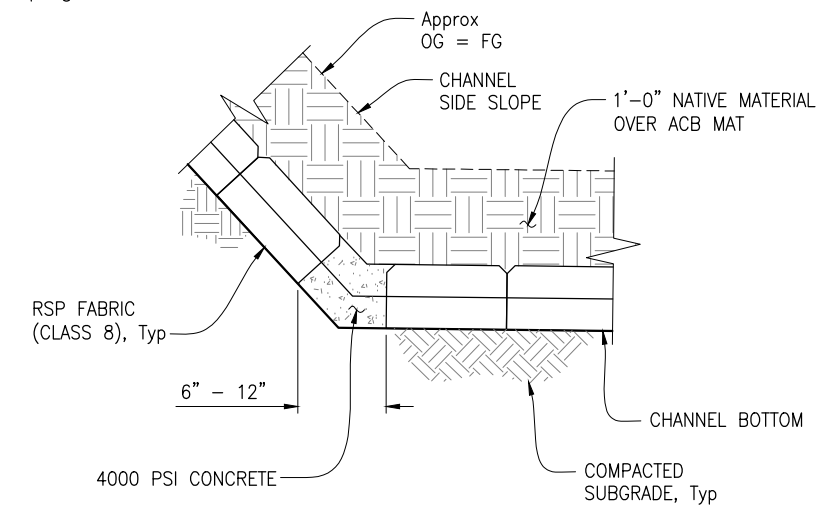

DETAIL "A"
1"=1'-0"

- NOTES:**
- Bend each #4 Dowel Bar 180° through revetment cable loops.
 - For Articulated Concrete Block (ACB) Mat Details, see "ARTICULATED CONCRETE BLOCK (ACB) MAT" sheet.

B-3

Submitted by: M. IMBRIANI Design Engineer C.E. No. 36634	
DESIGN BY: G. ANGEL	CHKD BY: C. PINKERTON
DRAWN BY: A. BEDAL	CHKD BY: G. ANGEL
SPECIFICATIONS WRITTEN BY: J. CONKLIN	CHKD BY: M. IMBRIANI
Approval Recommended by: Deputy Public Works Director, Engineering	

TRC

10680 White Rock Rd., Suite 100
Rancho Cordova, California 95670

ORIGINAL SCALE IN INCHES FOR REDUCED PLANS

0 1 2 3

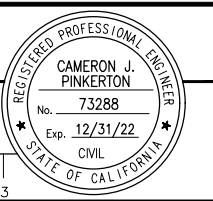

NO.	DATE	REVISION DESCRIPTION	APPROVED

MONTEREY COUNTY CALIFORNIA 1850

COUNTY OF MONTEREY
DEPT. OF PUBLIC WORKS,
FACILITIES & PARKS

1441 SCHILLING PLACE
SALINAS, CALIFORNIA 93901
(831) 755-4800/FAX (831) 755-4958

ROBINSON CANYON ROAD BRIDGE SCOUR COUNTERMEASURE PROJECT SCOUR PROTECTION DETAILS No.1			
STATE NO. 44C0017, BHLO-5944(099), COUNTY NO. 503			
DATE 09-10-21	FILE	PROJECT NO. 385165	SHEET 4
SCALE AS NOTED		CONTRACT NO.	OF 23 SHEETS

SHEET NUMBER	TOTAL SHEETS
5	23

APPENDIX V- PROJECT PLANS, SPECIFICATIONS AND ESTIMATE

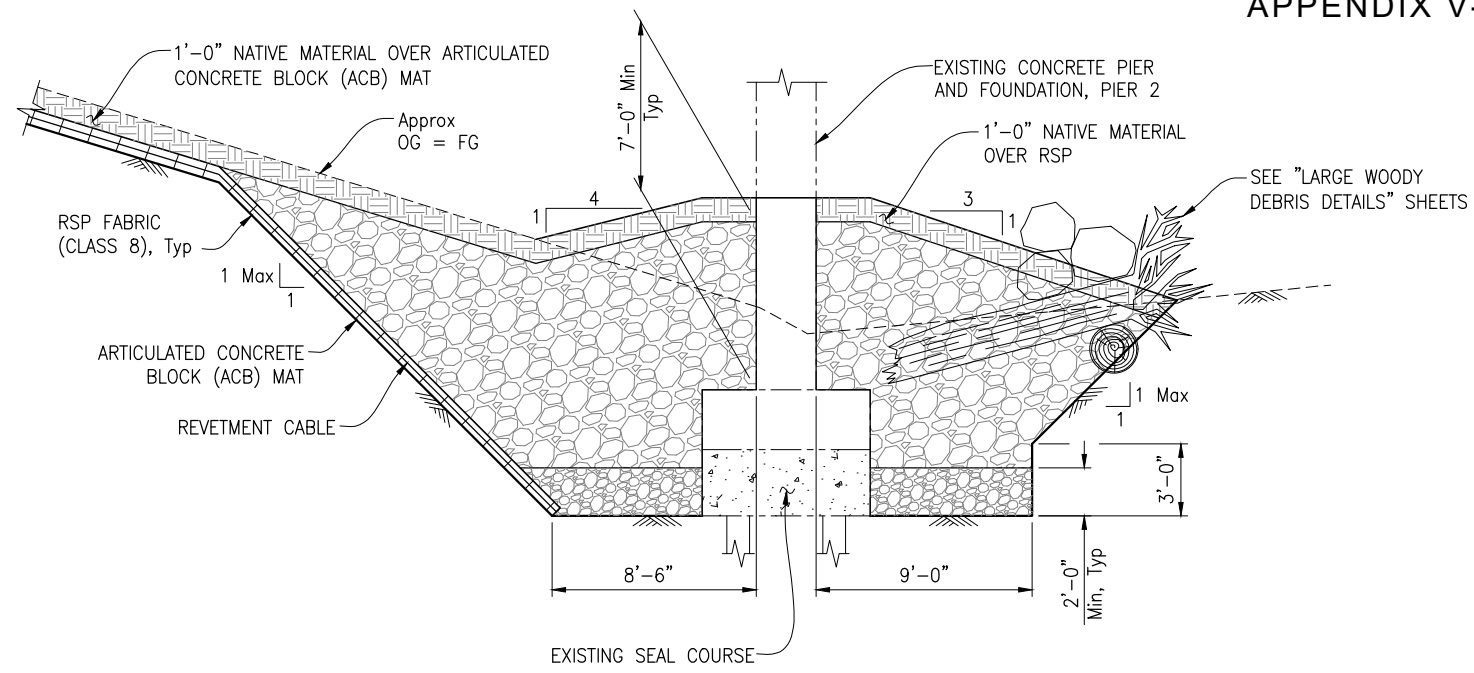

SECTION D-D
1/4"=1'-0"

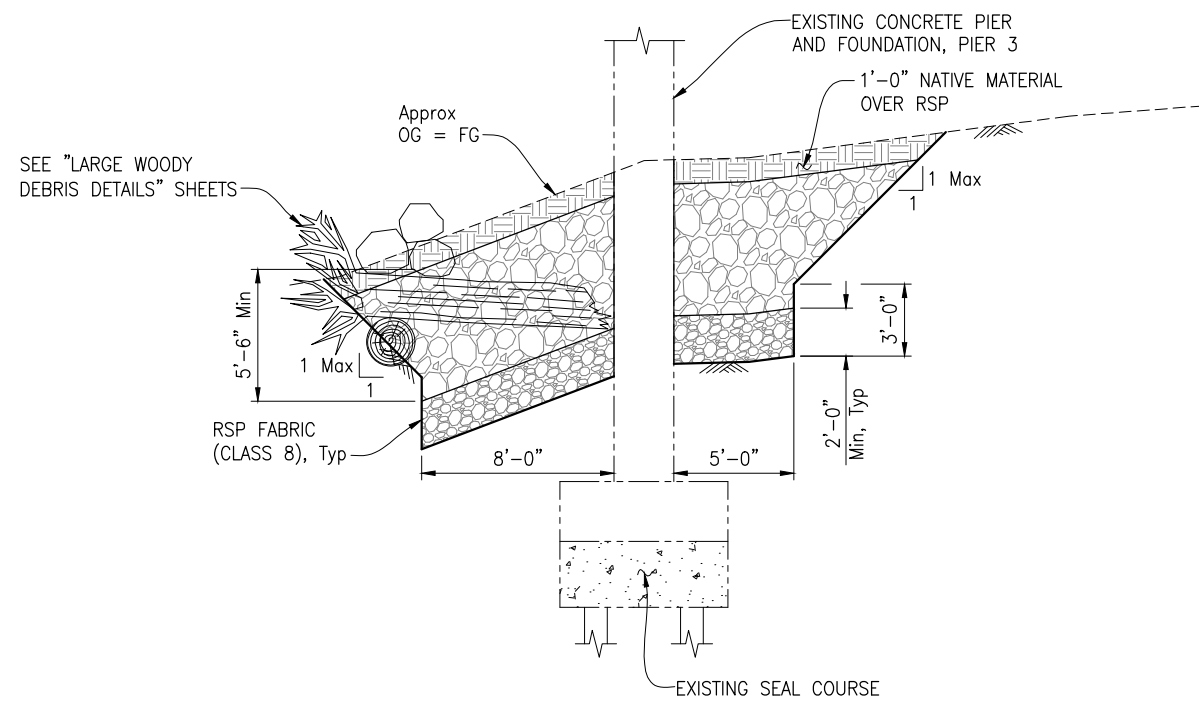

SECTION E-E
1/4"=1'-0"

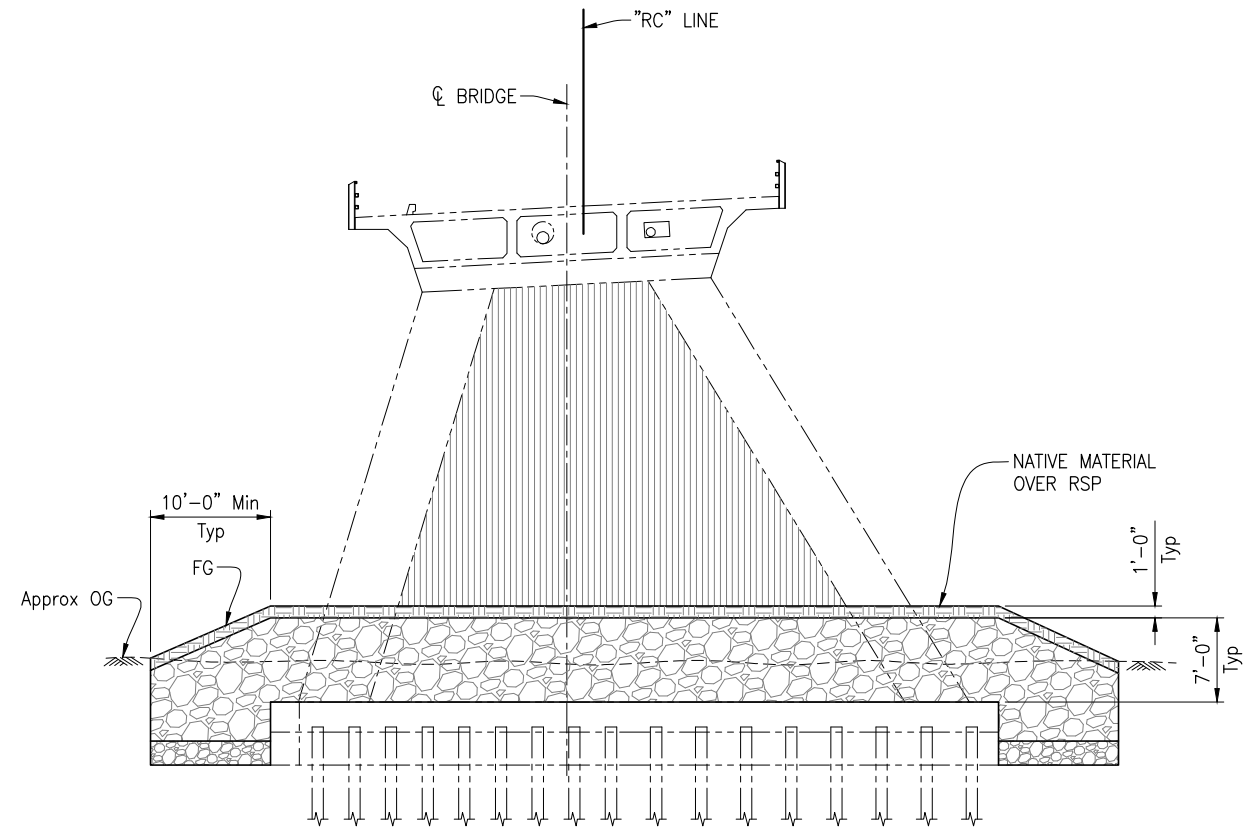

SECTION F-F
1/8"=1'-0"

LEGEND:

- Rock Slope Protection (1/2 Ton, Class VII Method B)
- Rock Slope Protection (60 lb, Class II Method B)

B-4

Submitted by: M. IMBRIANI Design Engineer C.E. No. 36634	
DESIGN BY: G. ANGEL	CHKD BY: C. PINKERTON
DRAWN BY: A. BEDAL	CHKD BY: G. ANGEL
SPECIFICATIONS WRITTEN BY: J. CONKLIN	CHKD BY: M. IMBRIANI
Approval Recommended by: _____ Deputy Public Works Director, Engineering	

TRC *Cameron J. Pinkerton*

10680 White Rock Rd., Suite 100
Rancho Cordova, California 95670

ORIGINAL SCALE IN INCHES FOR REDUCED PLANS

0 1 2 3

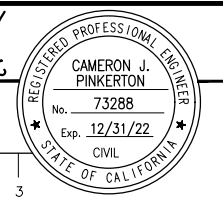

NO.	DATE	REVISION DESCRIPTION	APPROVED
△			
△			
△			
△			
△			

MONTEREY COUNTY CALIFORNIA
1850

COUNTY OF MONTEREY
DEPT. OF PUBLIC WORKS,
FACILITIES & PARKS

1441 SCHILLING PLACE
SALINAS, CALIFORNIA 93901
(831) 755-4800/FAX (831) 755-4958

ROBINSON CANYON ROAD BRIDGE SCOUR COUNTERMEASURE PROJECT SCOUR PROTECTION DETAILS No. 2			
STATE NO. 44C0017, BHLO-5944(099), COUNTY NO. 503			
DATE 09-10-21	FILE	PROJECT NO. 385165	SHEET 5
SCALE AS NOTED	CONTRACT NO.		OF 23 SHEETS

Drawing name: I:\262649 Robinson Canyon Road Bridge Structures\Details No.2.dwg Layout: Tab: A08 PILES Sep 29 2021 11:58am gimbien

SHEET NUMBER	TOTAL SHEETS
6	23

APPENDIX V- PROJECT PLANS, SPECIFICATIONS AND ESTIMATE

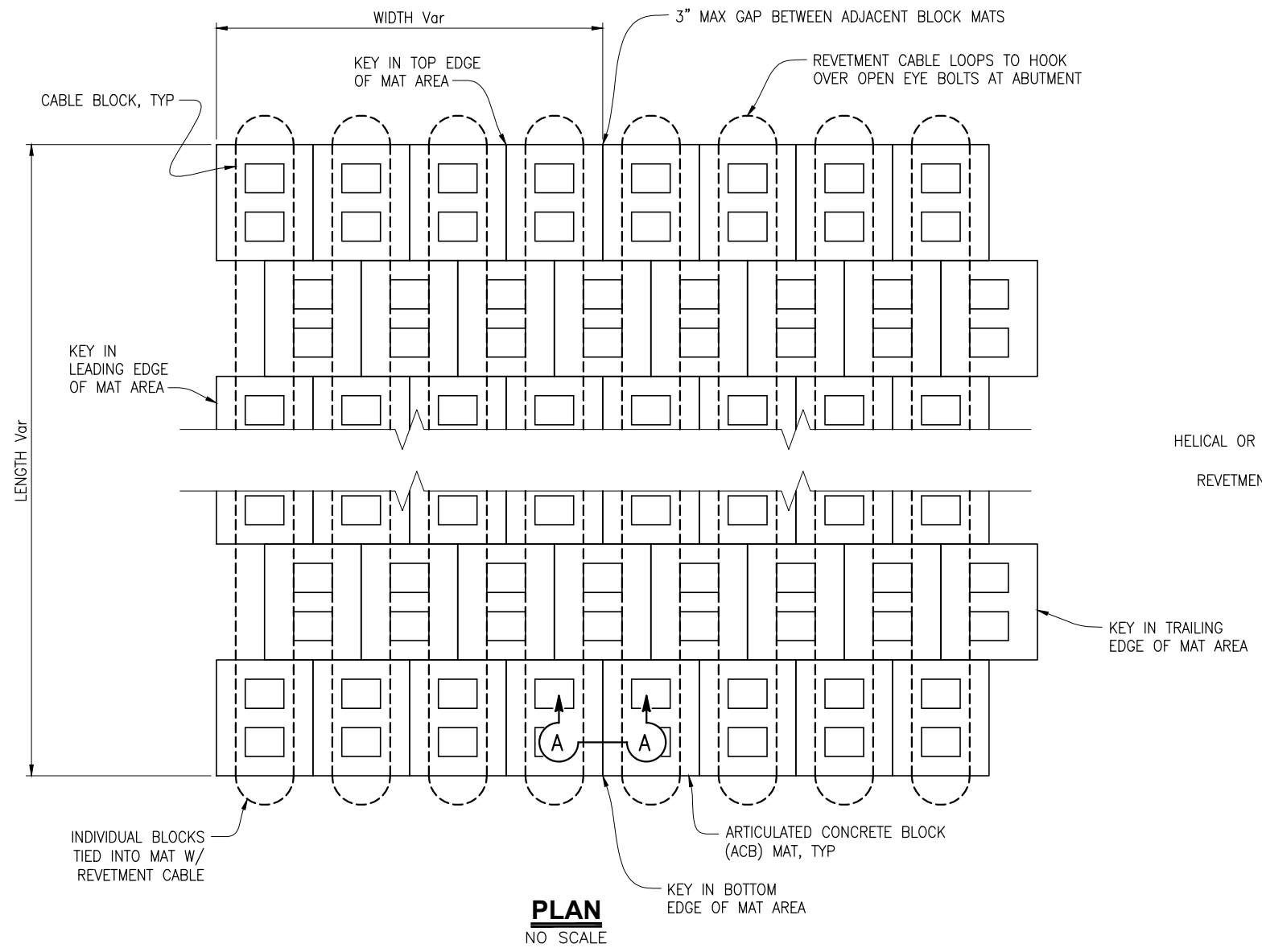

PLAN
NO SCALE

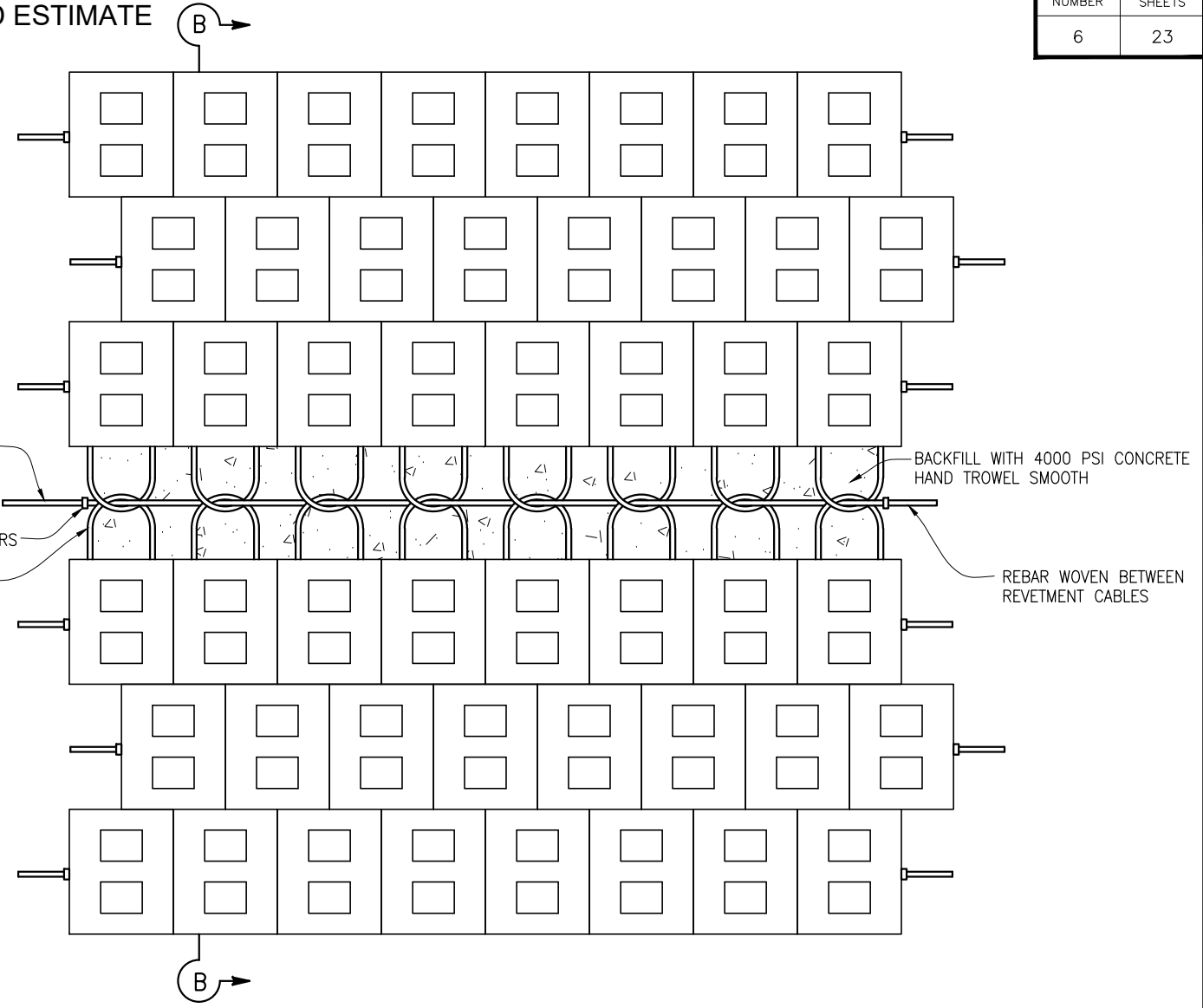

CONNECTION BETWEEN MATS WITH CONCRETE JOINT
NO SCALE

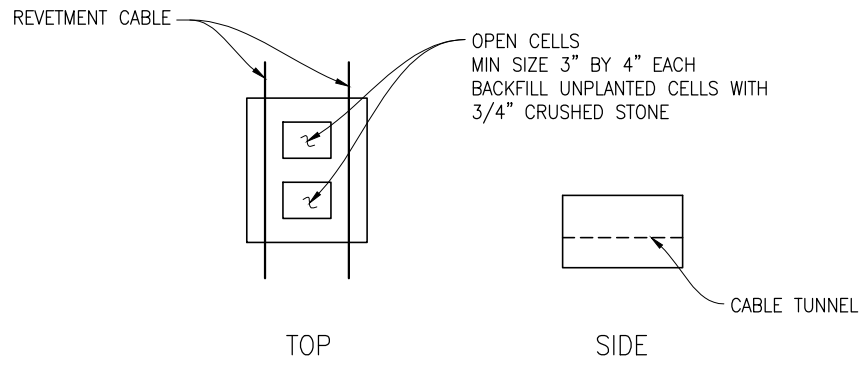

ARTICULATED CONCRETE BLOCK CELL BLOCK
NO SCALE

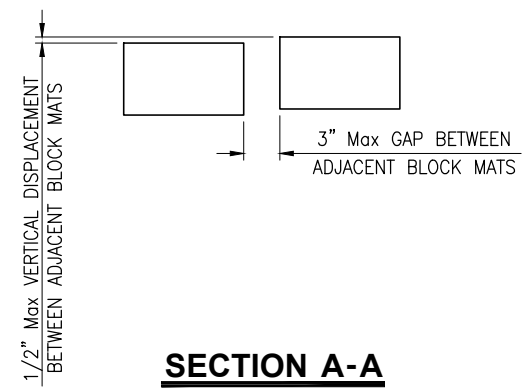

SECTION A-A
NO SCALE

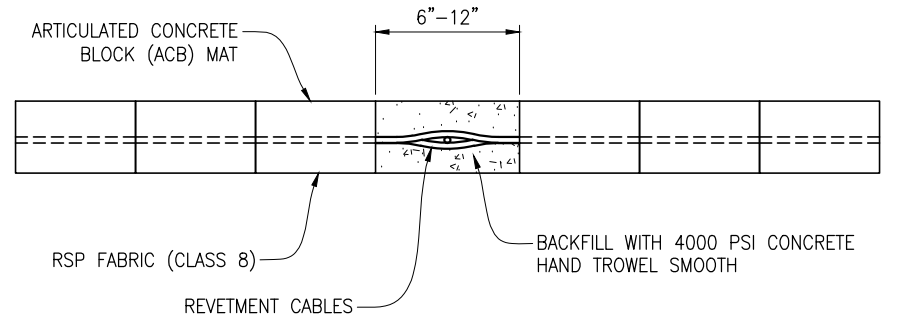

SECTION B-B
NO SCALE

B-5

Submitted by: M. IMBRIANI Design Engineer C.E. No. 36634	
DESIGN BY: G. ANGEL	CHKD BY: C. PINKERTON
DRAWN BY: A. BEDAL	CHKD BY: G. ANGEL
SPECIFICATIONS WRITTEN BY: J. CONKLIN	CHKD BY: M. IMBRIANI
Approval Recommended by: Deputy Public Works Director, Engineering	

TRC

10680 White Rock Rd., Suite 100
Rancho Cordova, California 95670

ORIGINAL SCALE IN INCHES FOR REDUCED PLANS

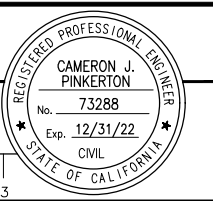

NO.	DATE	REVISION DESCRIPTION	APPROVED

MONTEREY COUNTY CALIFORNIA 1850

COUNTY OF MONTEREY
DEPT. OF PUBLIC WORKS,
FACILITIES & PARKS

1441 SCHILLING PLACE
SALINAS, CALIFORNIA 93901
(831) 755-4800/FAX (831) 755-4958

ROBINSON CANYON ROAD BRIDGE SCOUR COUNTERMEASURE PROJECT ARTICULATED CONCRETE BLOCK (ACB) MAT			
STATE NO. 44C0017, BHLO-5944(099), COUNTY NO. 503			
DATE	FILE	PROJECT NO.	SHEET
09-10-21		385165	6
SCALE	CONTRACT NO.	OF 23 SHEETS	
AS NOTED			

SHEET NUMBER	TOTAL SHEETS
7	23

NOTES:

- ALL UTILITY POLES TO BE PROTECTED IN PLACE.
- SEE TREE REMOVAL PLAN FOR ADDITIONAL TEMPORARY HIGH-VISIBILITY FENCE.

LINE DATA

X	DISTANCE	BEARING
L1	345.54'	N01°38'44"E
L2	145.89'	N77°04'50"W
L3	58.03'	N47°40'08"E
L4	18.78'	N65°09'09"E
L5	62.55'	N55°25'03"E
L6	71.54'	N9°28'35"E
L7	13.99'	S19°47'57"E
L8	28.47'	N68°10'10"E

CURVE DATA

X	R	Δ	L
C1	500.00'	37°36'56"	328.26'
C2	60.00'	124°44'58"	130.64'
C3	100.00'	17°29'01"	30.51'
C4	30.00'	93°46'42"	49.10'
C5	30.00'	34°20'54"	17.98'
C6	30.00'	29°16'31"	15.33'
C7	25.00'	92°01'52"	40.16'

TEMPORARY HIGH-VISIBILITY FENCE

X	LOCATION
1	17.25' Lt "RC" 207+85.22
2	35.00' Lt "RC" 208+01.34
3	42.37' Lt "RC" 209+22.65
4	216.26' Lt "RC" 211+72.87
5	234.54' Lt "RC" 212+12.54
6	252.08' Lt "RC" 212+15.55
7	251.29' Lt "RC" 212+25.29
8	233.25' Lt "RC" 212+40.21
9	18.70' Lt "RC" 213+35.04
10	180.78' Rt "RC" 209+48.02
11	185.81' Rt "RC" 209+68.95
12	221.54' Rt "RC" 209+73.75
13	217.80' Rt "RC" 210+55.57
14	216.47' Rt "RC" 210+66.60
15	120.81' Rt "RC" 210+64.80
16	49.96' Rt "RC" 212+76.71
17	214.66' Rt "RC" 213+40.08
18	212.97' Rt "RC" 214+16.47
19	111.07' Rt "RC" 214+23.61
20	98.71' Rt "RC" 214+43.80

- 1 0.50' ROCK
- 1.50' 90% RELATIVE COMPACTION NATIVE SOIL
- 2 GRAVEL EMBANKMENT

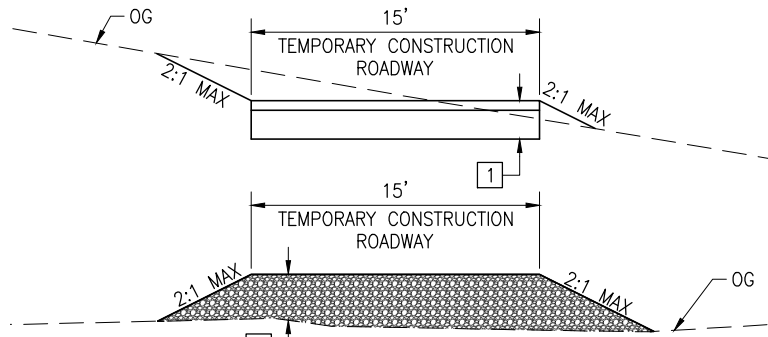

TYPICAL SECTIONS
1"=5'

LEGEND

- C CUT LIMIT
- F FILL LIMIT
- TEMPORARY HIGH-VISIBILITY FENCE
- R/W RIGHT-OF-WAY
- TCE TEMPORARY CONSTRUCTION EASEMENT
- OHWM APPROXIMATE ORDINARY HIGH WATER MARK
- PROPOSED CONSTRUCTION STAGING AREAS
- ROCK SLOPE PROTECTION, SEE SHEET B-2
- ARTICULATED CONCRETE BLOCK (ACB) MAT, SEE SHEET B-2
- GRAVEL EMBANKMENT

APPENDIX V- PROJECT PLANS, SPECIFICATIONS AND ESTIMATE

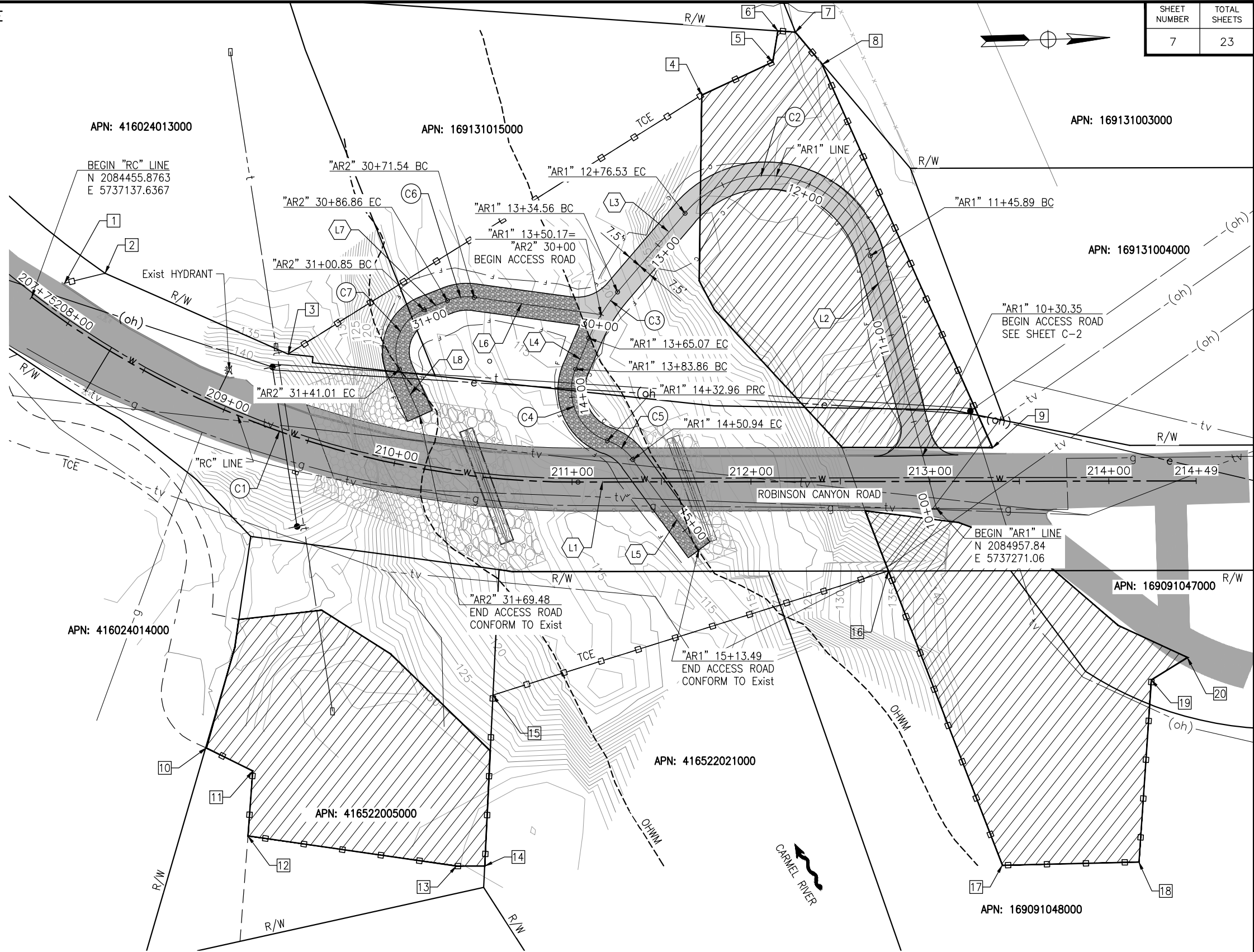

PLAN
1"=30'

C-1

Submitted by: M. IMBRIANI Design Engineer C.E. No. 36634	
DESIGN BY: A. BEDAL	CHKD BY: J. CONKLIN
DRAWN BY: A. BEDAL	CHKD BY: J. CONKLIN
SPECIFICATIONS WRITTEN BY: J. CONKLIN	CHKD BY: M. IMBRIANI
Approval Recommended by: Deputy Public Works Director, Engineering	



10680 White Rock Rd., Suite 100
Rancho Cordova, California 95670

ORIGINAL SCALE IN INCHES FOR REDUCED PLANS

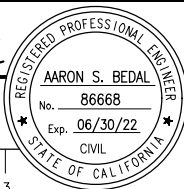

NO.	DATE	REVISION DESCRIPTION	APPROVED



COUNTY OF MONTEREY
DEPT. OF PUBLIC WORKS,
FACILITIES & PARKS

1441 SCHILLING PLACE
SALINAS, CALIFORNIA 93901
(831) 755-4800/FAX (831) 755-4958

**ROBINSON CANYON ROAD BRIDGE
SCOUR COUNTERMEASURE PROJECT
CONSTRUCTION DETAILS**
STATE NO. 44C0017, BHLO-5944(099), COUNTY NO. 503

DATE 09-10-21	FILE	PROJECT NO. 385165	SHEET 7
SCALE 1"=30'	CONTRACT NO.	OF 23 SHEETS	

Drawing name: I:\262649 Robinson Canyon Road Bridge\Sheets\C-1.dwg Layout Tab: L-1 Sep 28 2021 12:20 pm gmbsean

SHEET NUMBER	TOTAL SHEETS
8	23

APPENDIX V- PROJECT PLANS, SPECIFICATIONS AND ESTIMATE

CURVE DATA				
CURVE	R	Δ	T	L
C1	15.00'	76°49'44"	11.90'	20.11'
C2	15.00'	104°57'36"	19.53'	27.48'

NOTES:

- EXISTING DIKE TO BE REMOVED AND REPLACES IF NECESSARY FOR CONSTRUCTION ACCESS

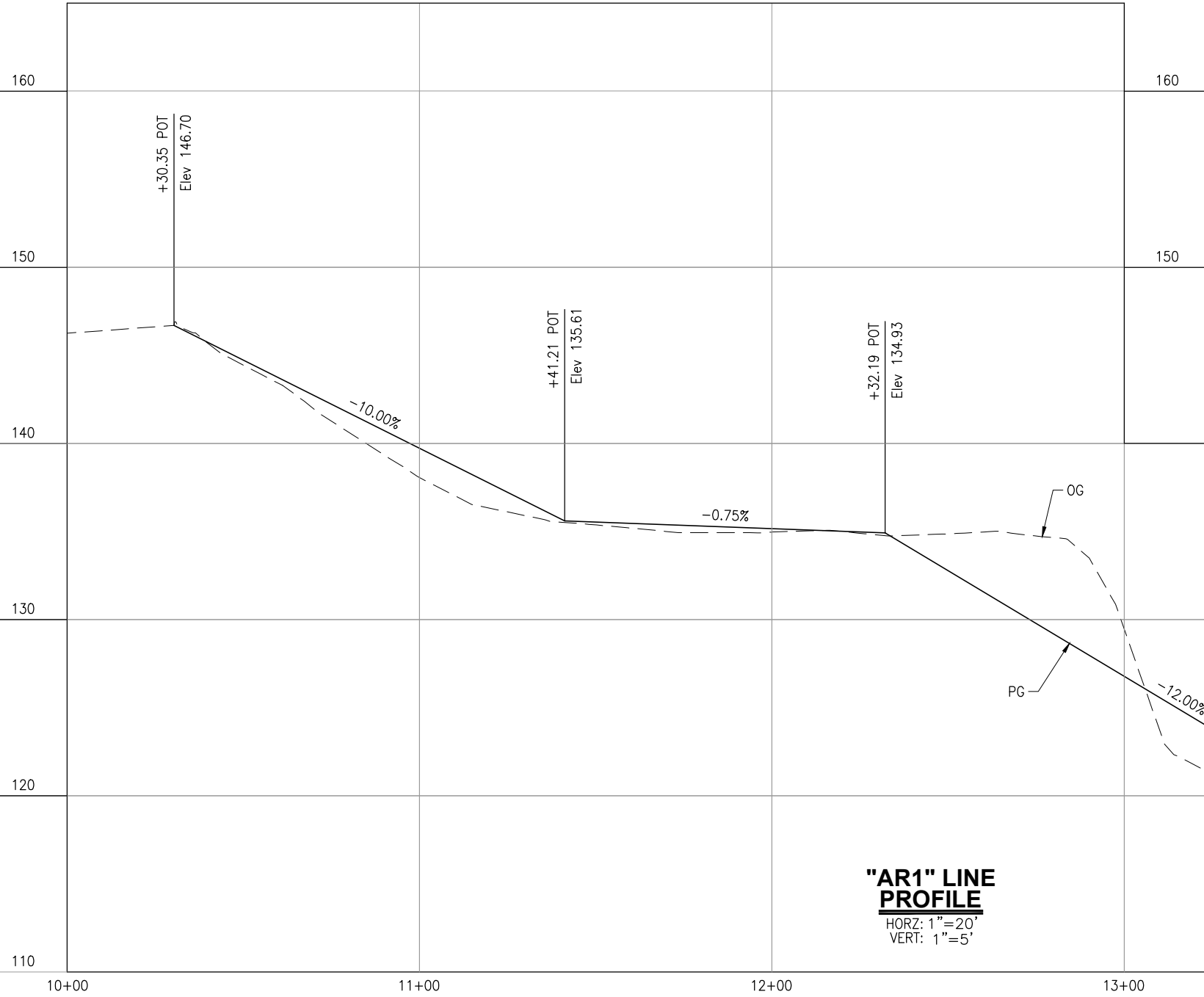

"AR1" LINE PROFILE
 HORZ: 1"=20'
 VERT: 1"=5'

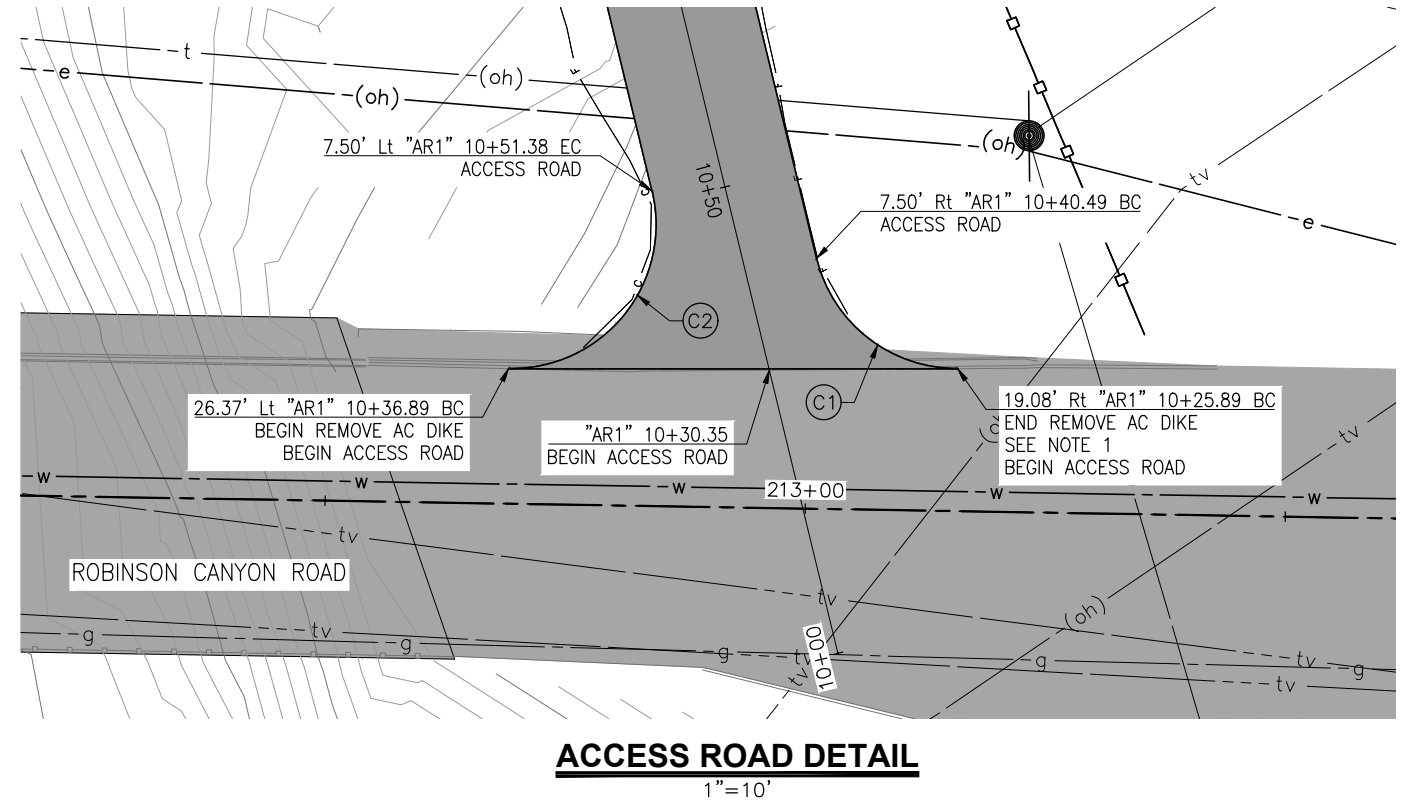

ACCESS ROAD DETAIL
 1"=10'

C-2

Drawing name: \\1726549-Robinson Canyon Road Bridge\Sheets\C-2 and C-3.dwg Layout: Tab: P-1 Sep 28 2021 12:24pm gjmben

Submitted by: M. IMBRIANI Design Engineer C.E. No. 36634	
DESIGN BY: A. BEDAL	CHKD BY: J. CONKLIN
DRAWN BY: N. HERNANDEZ	CHKD BY: J. CONKLIN
SPECIFICATIONS WRITTEN BY: J. CONKLIN	CHKD BY: M. IMBRIANI
Approval Recommended by: _____ Deputy Public Works Director, Engineering	

TRC Aaron Bedal
 10680 White Rock Rd., Suite 100
 Rancho Cordova, California 95670

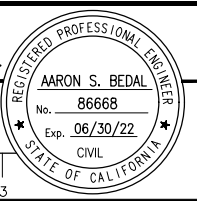

NO.	DATE	REVISION DESCRIPTION	APPROVED

COUNTY OF MONTEREY
 DEPT. OF PUBLIC WORKS,
 FACILITIES & PARKS
 1441 SCHILLING PLACE
 SALINAS, CALIFORNIA 93901
 (831) 755-4800/FAX (831) 755-4958

ROBINSON CANYON ROAD BRIDGE SCOUR COUNTERMEASURE PROJECT CONSTRUCTION DETAILS			
STATE NO. 44C0017, BHLO-5944(099), COUNTY NO. 503			
DATE 09-10-21	FILE	PROJECT NO. 385165	SHEET 8
SCALE 1"=20'	CONTRACT NO.		OF 23 SHEETS

SHEET NUMBER	TOTAL SHEETS
9	23

APPENDIX V- PROJECT PLANS, SPECIFICATIONS AND ESTIMATE

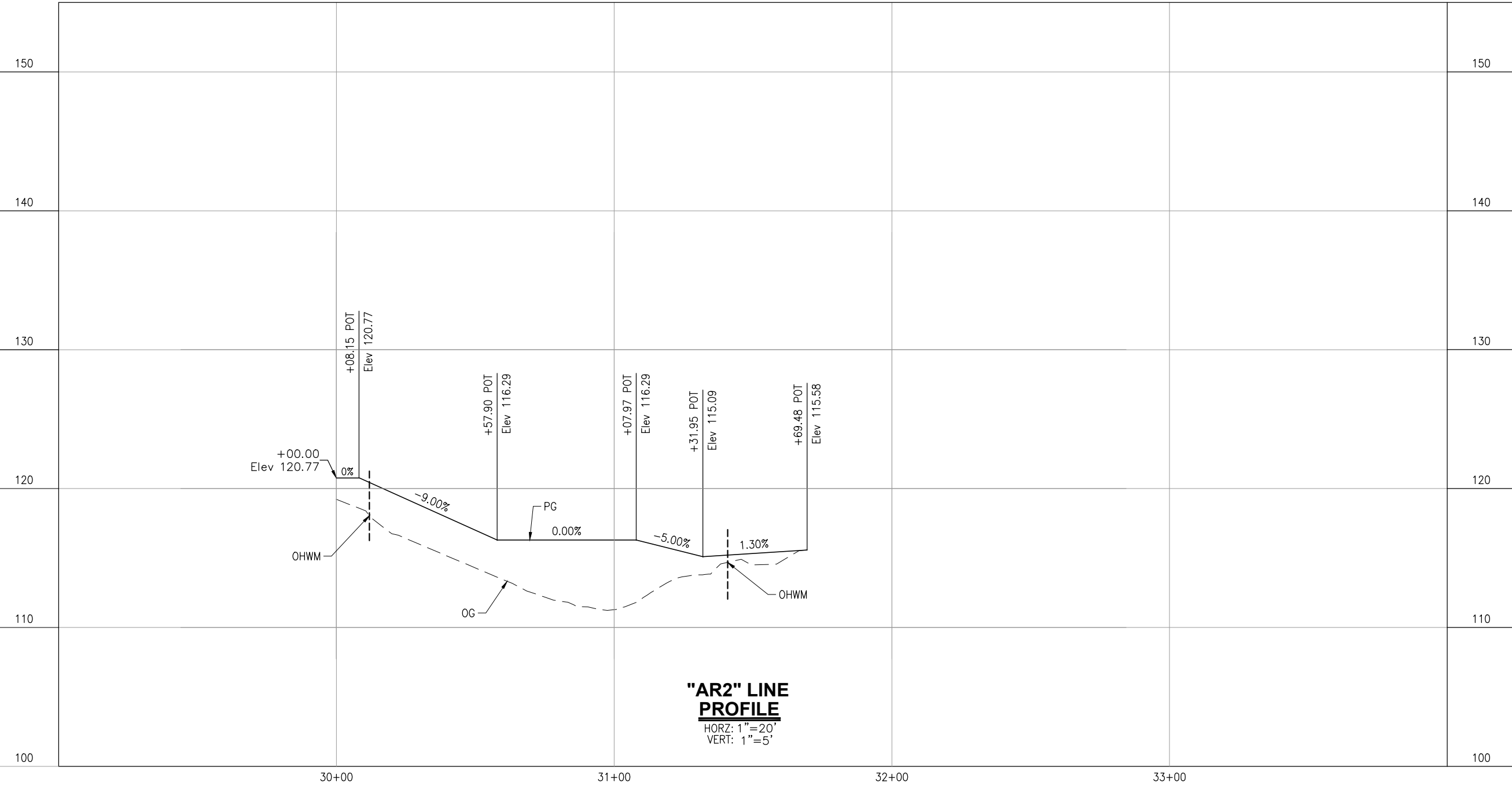

"AR2" LINE PROFILE
 HORZ: 1"=20'
 VERT: 1"=5'

C-3

Submitted by: M. IMBRIANI Design Engineer C.E. No. 36634	
DESIGN BY: N. HERNANDEZ	CHKD BY: J. CONKLIN
DRAWN BY: N. HERNANDEZ	CHKD BY: J. CONKLIN
SPECIFICATIONS WRITTEN BY: J. CONKLIN	CHKD BY: M. IMBRIANI
Approval Recommended by: _____ Deputy Public Works Director, Engineering	

TRC *Aaron Bedal*

10680 White Rock Rd., Suite 100
 Rancho Cordova, California 95670

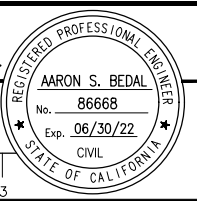

NO.	DATE	REVISION DESCRIPTION	APPROVED

COUNTY OF MONTEREY
 DEPT. OF PUBLIC WORKS,
 FACILITIES & PARKS

1441 SCHILLING PLACE
 SALINAS, CALIFORNIA 93901
 (831) 755-4800/FAX (831) 755-4958

ROBINSON CANYON ROAD BRIDGE SCOUR COUNTERMEASURE PROJECT CONSTRUCTION DETAILS			
STATE NO. 44C0017, BHLO-5944(099), COUNTY NO. 503			
DATE 09-10-21	FILE	PROJECT NO. 385165	SHEET 9
SCALE 1"=20'		CONTRACT NO.	
		OF 23 SHEETS	

Drawing name: I:\262649 Robinson Canyon Road Bridge\Sheets\C-2 and C-3.dwg Layout: Tab: P-2 Sep 28 2021 12:04pm jimbsen

APPENDIX V- PROJECT PLANS, SPECIFICATIONS AND ESTIMATE

SHEET NUMBER	TOTAL SHEETS
10	23

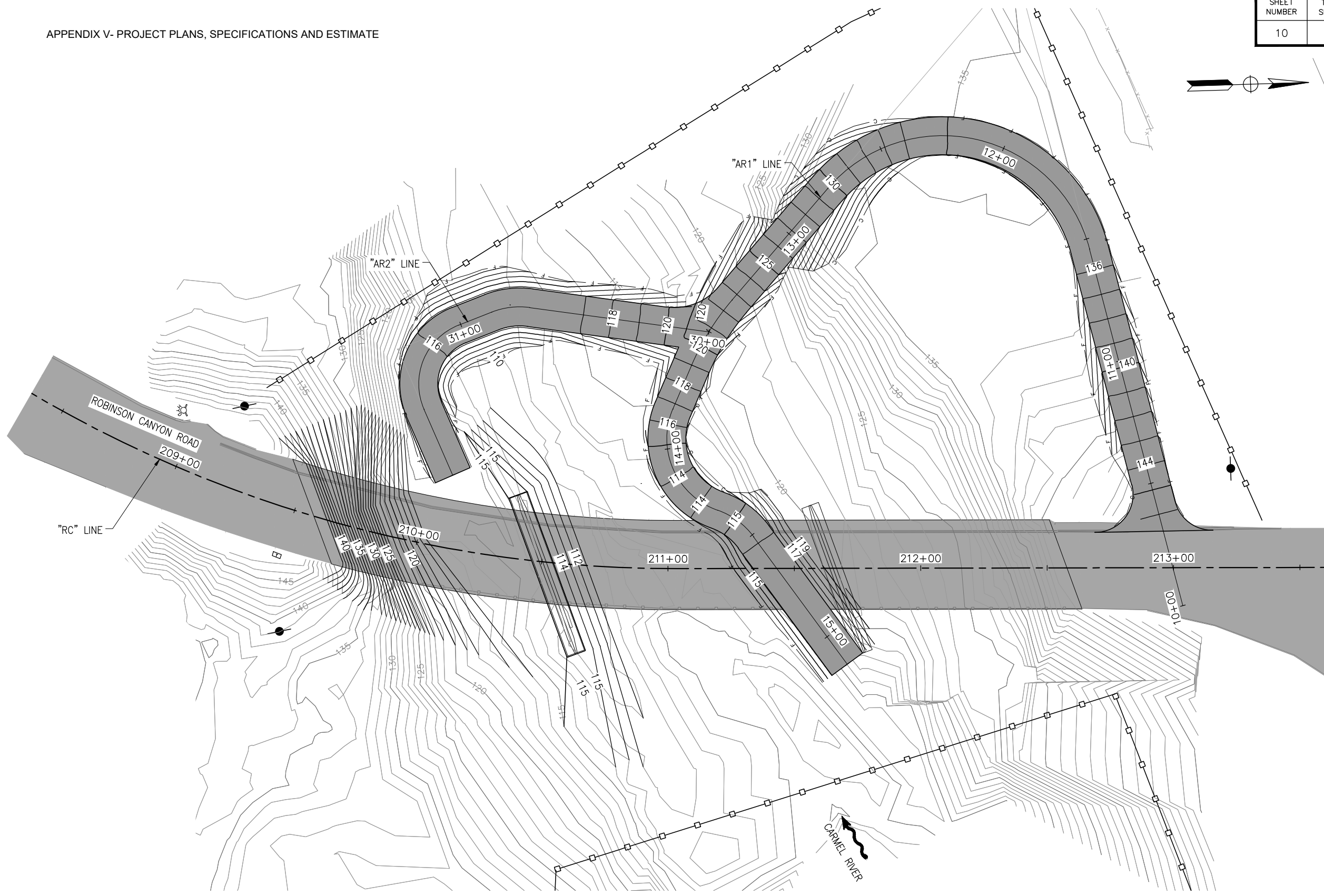
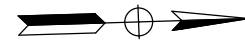

PLAN
1"=20'

G-1

Submitted by: M. IMBRIANI Design Engineer C.E. No. 36634	
DESIGN BY: N. HERNANDEZ	CHKD BY: J. CONKLIN
DRAWN BY: N. HERNANDEZ	CHKD BY: J. CONKLIN
SPECIFICATIONS WRITTEN BY: J. CONKLIN	CHKD BY: M. IMBRIANI
Approval Recommended by: _____ Deputy Public Works Director, Engineering	

TRC *Aaron Bedal*

10680 White Rock Rd., Suite 100
Rancho Cordova, California 95670

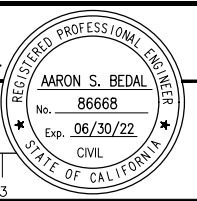

NO.	DATE	REVISION DESCRIPTION	APPROVED
△			
△			
△			
△			



COUNTY OF MONTEREY
DEPT. OF PUBLIC WORKS,
FACILITIES & PARKS

1441 SCHILLING PLACE
SALINAS, CALIFORNIA 93901
(831) 755-4800/FAX (831) 755-4958

ROBINSON CANYON ROAD BRIDGE			
SCOUR COUNTERMEASURE PROJECT			
CONTOUR GRADING PLAN			
STATE NO. 44C0017, BHLO-5944(099), COUNTY NO. 503			
DATE 09-10-21	FILE	PROJECT NO. 385165	SHEET 10
SCALE 1"=20'		CONTRACT NO.	
		OF 23 SHEETS	

Drawing name: I:\262649 Robinson Canyon Road Bridge\Sheets\Grading\Plan\chng - Layout Tab: G-1 Sep 28, 2021 12:05pm gjmbasen

SHEET NUMBER	TOTAL SHEETS
11	23

NOTES:

1. ALL UTILITY POLES TO BE PROTECTED IN PLACE.
2. LOCATION OF UTILITY FACILITIES SHOWN ON THE PLANS ARE APPROXIMATE AND SHALL BE VERIFIED BY THE CONTRACTOR PRIOR TO CONSTRUCTION.

APPENDIX V- PROJECT PLANS, SPECIFICATIONS AND ESTIMATE

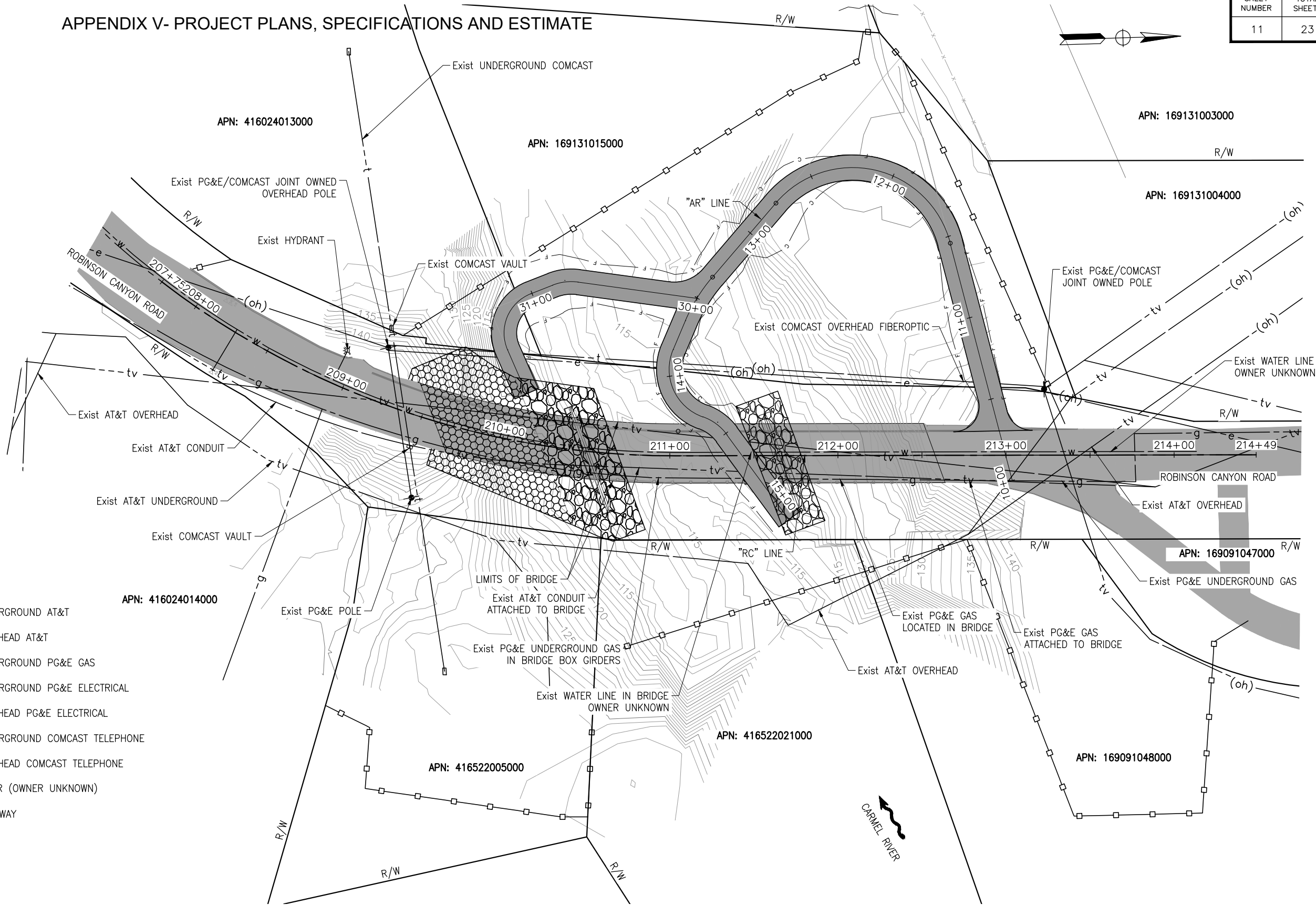

LEGEND

- tv---tv--- Exist UNDERGROUND AT&T
- (oh)---tv--- Exist OVERHEAD AT&T
- g--- Exist UNDERGROUND PG&E GAS
- e--- Exist UNDERGROUND PG&E ELECTRICAL
- e---(oh)--- Exist OVERHEAD PG&E ELECTRICAL
- t--- Exist UNDERGROUND COMCAST TELEPHONE
- t---(oh)--- Exist OVERHEAD COMCAST TELEPHONE
- w--- Exist WATER (OWNER UNKNOWN)
- R/W--- RIGHT-OF-WAY

PLAN
1"=30'

NO WORK ON THIS SHEET - FOR INFORMATION ONLY

U-1

Submitted by: M. IMBRIANI Design Engineer C.E. No. 36634	
DESIGN BY: A. BEDAL	CHKD BY: J. CONKLIN
DRAWN BY: A. BEDAL	CHKD BY: J. CONKLIN
SPECIFICATIONS WRITTEN BY: J. CONKLIN	CHKD BY: M. IMBRIANI
Approval Recommended by: _____ Deputy Public Works Director, Engineering	

TRC Aaron Bedal
10680 White Rock Rd., Suite 100
Rancho Cordova, California 95670

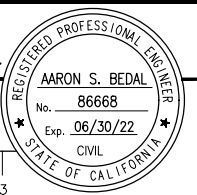

NO.	DATE	REVISION DESCRIPTION	APPROVED



COUNTY OF MONTEREY
DEPT. OF PUBLIC WORKS,
FACILITIES & PARKS
1441 SCHILLING PLACE
SALINAS, CALIFORNIA 93901
(831) 755-4800/FAX (831) 755-4958

ROBINSON CANYON ROAD BRIDGE SCOUR COUNTERMEASURE PROJECT UTILITY PLAN			
STATE NO. 44C0017, BHL0-5944(099), COUNTY NO. 503			
DATE 09-10-21	FILE	PROJECT NO. 385165	SHEET 11
SCALE 1"=30'		CONTRACT NO.	
OF 23 SHEETS			

Drawing name: I:\262649 Robinson Canyon Road Bridge\Sheets\UTILITY.dwg Layout: Tab: U-1 Sep 28 2021 12:07pm gmbisen

SHEET NUMBER	TOTAL SHEETS
12	23

TREE REMOVAL TABLE		
XX	SIZE	TYPE
1	8"	WILLOW
2	6"	WILLOW
3	10"	COTTONWOOD
4	16"	ALDER
5	8"	WILLOW
6	6"	WILLOW
7	10"	WILLOW
8	14"	WILLOW
9	20"	OAK
10	10"	SYCAMORE
11	14"	COTTONWOOD
12	10"	SYCAMORE
13	14"	COTTONWOOD
14	14"	COTTONWOOD
15	16"	COTTONWOOD
16	12"	SYCAMORE
17	10"	WILLOW
18	16"	WILLOW
19	6"	ALDER
20	10"	WILLOW
21	10"	COTTONWOOD
22	24"	COTTONWOOD
23	18"	COTTONWOOD
24	12"	OAK
25	14"	OAK
26	8"	OAK
27	12"	WILLOW
28	6"	COTTONWOOD
29	12"	COTTONWOOD
30	24"	COTTONWOOD
31	18"	COTTONWOOD
32	24"	COTTONWOOD
33	24"	COTTONWOOD
34	10"	OAK
35	12"	OAK
36	12"	OAK
37	30"	OAK
38	16"	COTTONWOOD
39	22"	COTTONWOOD
40	22"	COTTONWOOD
41	36"	COTTONWOOD
42	22"	COTTONWOOD
43	6"	WILLOW
44	8"	WILLOW
45	6"	WILLOW
46	22"	COTTONWOOD
47	6"	WILLOW
48	14"	ALDER
49	18"	ALDER
50	18"	ALDER
51	14"	ALDER
52	8"	COTTONWOOD

NOTES:

- EXACT LIMITS OF TEMPORARY HIGH-VISIBILITY FENCE TO BE DETERMINED BY CONTRACTOR-SUPPLIED BIOLOGIST.
- ATTENTION IS DIRECTED TO TREES TO REMAIN WITHIN PROJECT LIMITS SHALL BE PROTECTED IN PLACE AND HAVE TEMPORARY HIGH-VISIBILITY FENCE AROUND THEM AS SHOWN.

ABBREVIATION:

OHWM ORDINARY HIGH WATER MARK

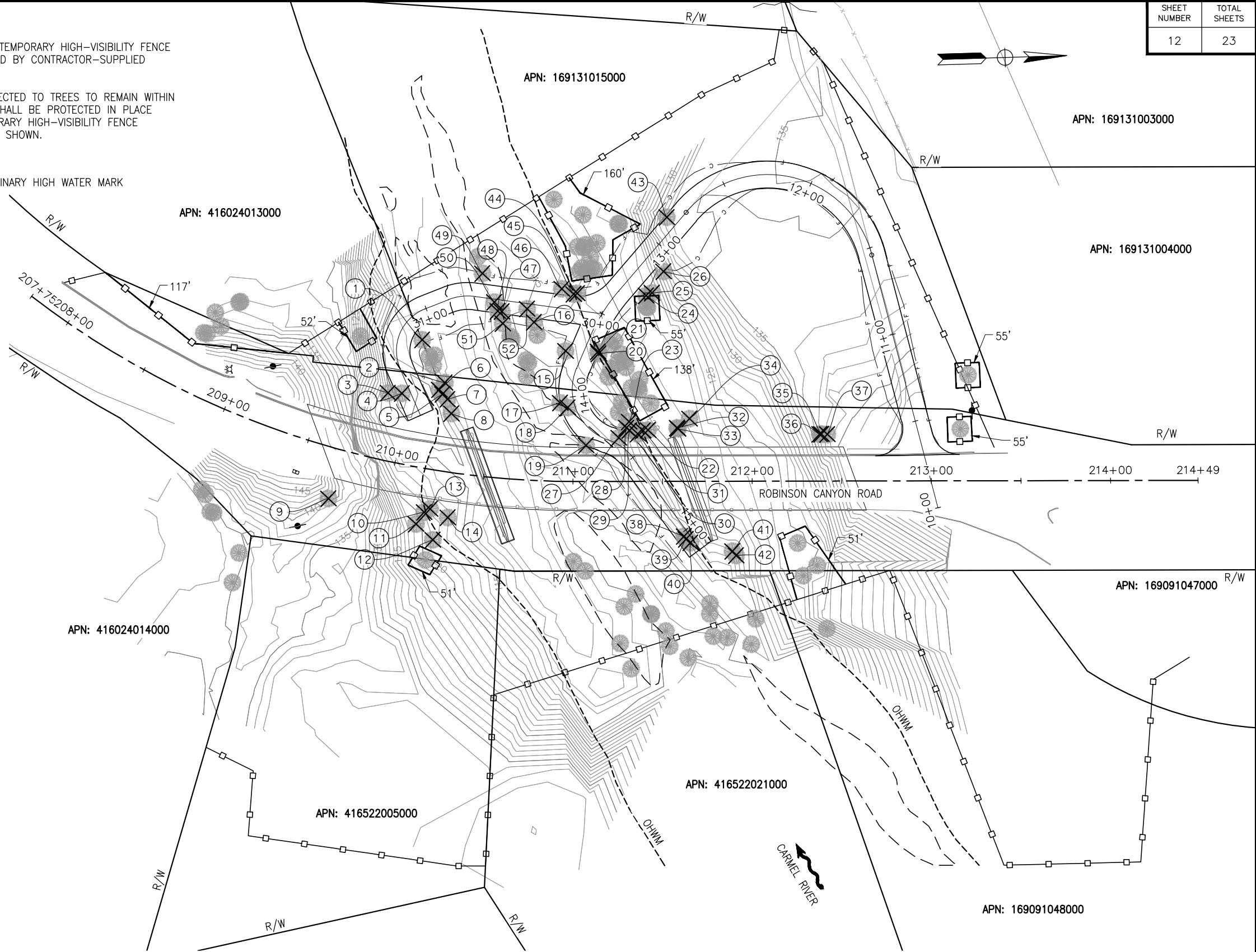

LEGEND

- TREE TO BE REMOVED
- TREE TO REMAIN
- WETLAND
- TEMPORARY HIGH-VISIBILITY FENCE
- OHWM APPROXIMATE ORDINARY HIGH WATER MARK

APPENDIX V- PROJECT PLANS, SPECIFICATIONS AND ESTIMATE

PLAN
1"=30'

TR-1

Submitted by: M. IMBRIANI Design Engineer C.E. No. 36634	
DESIGN BY: D. LOCKETT	CHKD BY: J. CONKLIN
DRAWN BY: D. LOCKETT	CHKD BY: J. CONKLIN
SPECIFICATIONS WRITTEN BY: J. CONKLIN	CHKD BY: M. IMBRIANI
Approval Recommended by: _____ Deputy Public Works Director, Engineering	

TRC Aaron Bedal
10680 White Rock Rd., Suite 100
Rancho Cordova, California 95670

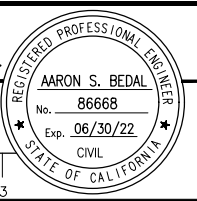

NO.	DATE	REVISION DESCRIPTION	APPROVED

COUNTY OF MONTEREY
DEPT. OF PUBLIC WORKS,
FACILITIES & PARKS
1441 SCHILLING PLACE
SALINAS, CALIFORNIA 93901
(831) 755-4800/FAX (831) 755-4958

ROBINSON CANYON ROAD BRIDGE SCOUR COUNTERMEASURE PROJECT TREE REMOVAL PLAN			
STATE NO. 44C0017, BHLO-5944(099), COUNTY NO. 503			
DATE 09-10-21	FILE	PROJECT NO. 385165	SHEET 12
SCALE 1"=30'		CONTRACT NO.	
OF 23 SHEETS			

Drawing name: I:\262649 Robinson Canyon Road Bridge\Sheets\TR-1.dwg Layout: Iob: TR-1 Sep 26 2021 12:20:58pm gjmbisen

SHEET NUMBER	TOTAL SHEETS
13	23

NOTES:

1. THE SCOPE OF WORK INCLUDES INSTALLING PLANT MATERIAL AS WELL AS MAINTENANCE, IRRIGATION, MONITORING, AND REPORTING FOR THE PLANT ESTABLISHMENT PERIOD. THE PLANT ESTABLISHMENT PERIOD BEGINS WHEN THE ENGINEER HAS ACCEPTED THE INSTALLATION OF ALL PLANT MATERIAL IN WRITING AND PROVIDED A PLANT ESTABLISHMENT PERIOD TO START DATE. THE PLANT ESTABLISHMENT PERIOD SHALL BEGIN AFTER PLANTS HAVE BEEN INSTALLED, AND SHALL EXTEND FOR A PERIOD OF FIVE YEARS OR AS REQUIRED BY REGULATORY AGENCY PERMITS. THE PLANT ESTABLISHMENT PERIOD ENDS WHEN PERFORMANCE STANDARDS FOR VEGETATION SURVIVAL AND COVER HAVE BEEN MET AND DEMONSTRATED TO THE SATISFACTION OF REGULATORY AGENCIES.
2. DISTURBED PORTIONS OF THE CARMEL RIVER CHANNEL AND BANKS WILL BE REPLANTED WITH NATIVE SPECIES, INCLUDING LOCALLY-HARVESTED WILLOW AND COTTONWOOD CUTTINGS, NURSERY CONTAINER STOCK, AND NATIVE SEED MIX.
3. WILLOW AND COTTONWOOD CUTTINGS AS WELL AS CONTAINER STOCK WILL BE PLANTED WITHIN THE SOIL-FILLED RIP RAP.
4. PLANTS AND SEED SHALL BE THE SPECIES, SIZE, FORM, AND QUANTITY AS SPECIFIED ON THE PLANS. PLANTING QUANTITIES SHOULD BE ADJUSTED AS NEEDED TO ENHANCE UNDISTURBED RIPARIAN AREAS. THE CONTRACTOR SHALL BE RESPONSIBLE FOR VERIFYING QUANTITIES PRIOR TO ARRANGING FOR DELIVERY OF ALL PLANTS.
5. PLANTS MUST BE PROTECTED FROM SUN, WIND, AND DEHYDRATION DURING TRANSPORT AND STORAGE AT THE SITE. ALL NURSERY STOCK SHALL BE PLACED IN A PROTECTED LOCATION ON SITE UPON DELIVERY. PLANTS SHALL BE PROTECTED FROM DESICCATION, HARSH WEATHER CONDITIONS (INCLUDING FROST AND WIND) AND MECHANICAL DAMAGE.
6. THE CONTRACTOR SHALL STAKE OUT THE BOUNDARIES OF THE PLANTING ZONES AS DEPICTED ON THE PLANS. INDIVIDUAL CONTAINERIZED PLANT LOCATIONS SHALL BE MARKED USING COLORED AND LABELED PIN FLAGS (WITH THE COLORS AND LABELS REPRESENTING EACH SPECIES). BEFORE PLANTING MAY BEGIN, THE LAYOUT MUST BE APPROVED BY THE ENGINEER.
7. FOLIAGE PROTECTORS SHALL BE PLACED AROUND ALL INSTALLED NURSERY CONTAINER STOCK.
8. KEEP CONTRACT AREAS FREE OF WEEDS BY CULTIVATING, HOING, OR HAND PULLING DURING THE PLANT ESTABLISHMENT PERIOD. THE WEEDING METHODS SHALL NOT DAMAGE VOLUNTEER NATIVE WOODY VEGETATION, INSTALLED PLANTS, OR EXISTING NATIVE VEGETATION. WEEDING SHALL BE CONDUCTED FOLLOWING MANUAL HAND WEEDING. PESTICIDES OR HERBICIDES MAY BE USED TO CONTROL WEEDS IF ALLOWED BY REGULATORY AGENCY PERMITS.
9. THE CONTRACTOR WILL IRRIGATE THE NATIVE PLANTINGS WITH USE OF A WATER TRUCK, TEMPORARY/MOBILE WATER BUFFALO, TEMPORARY DRIP IRRIGATION SYSTEM, OR SIMILAR METHOD. PLANTS SHALL BE IRRIGATED DURING THE MONTHS OF APRIL THROUGH OCTOBER. AS A GENERAL GUIDELINE, PLANTS SHOULD BE WATERED ONCE PER WEEK DURING THE FIRST YEAR, ONCE EVERY TWO WEEKS DURING THE SECOND YEAR, AND ONCE EVERY THREE WEEKS DURING THE THIRD YEAR, OR AS NEEDED TO ENSURE SURVIVAL OF PLANTINGS. ADAPTIVE MANAGEMENT PRACTICES SHALL BE UTILIZED BY THE CONTRACTOR, AS NEEDED, TO ENSURE PLANT SURVIVORSHIP. THE CONTRACTOR WILL BE RESPONSIBLE FOR PURCHASING THE WATER NEEDED FOR IRRIGATION.
10. TO COMPENSATE FOR PLANT MORTALITY, THE CONTRACTOR IS REQUIRED TO ACQUIRE AND INSTALL ADDITIONAL PLANTS IN THE FIRST YEAR OF ESTABLISHMENT IF SURVIVORSHIP OF THE CONTAINERIZED PLANTS FALL BELOW 100% OF THE ORIGINAL NUMBER INSTALLED. PLANTS SHALL BE FREE OF EXCESSIVE DEAD OR DYING BRANCHES AND BRANCH TIPS, WITH FOLIAGE OF NORMAL DENSITY, SIZE, AND COLOR. REPAIR AND/OR REPLACE AT NO ADDITIONAL COST TO THE CITY ALL PLANT MATERIALS EXHIBITING CONDITIONS WHICH ARE DETERMINED AS UNACCEPTABLE DUE TO WORKMANSHIP BY CONTRACTOR. CONTRACTOR WILL NOT BE HELD RESPONSIBLE FOR FAILURES DUE TO VANDALISM AND NATURAL DISASTER, SUCH AS FIRE OR SEVERE FLOODING. A REPLACEMENT PLANTING PLAN SHALL BE PREPARED BY THE CONTRACTOR AND APPROVED BY THE ENGINEER PRIOR TO IMPLEMENTATION. ADAPTIVE MANAGEMENT STRATEGIES SHALL BE EMPLOYED TO DETERMINE THE CAUSE OF DEATH AND THE BEST SUITED SPECIES FOR REPLACEMENT FOR THOSE PLANTS THAT PERISHED. THE REPLACEMENT PLANTS SHALL BE THE SAME SPECIES.
11. MONITORING AND REPORTING DURING THE PLANT ESTABLISHMENT PERIOD WILL BE PERFORMED ACCORDING TO THE REQUIREMENTS SPECIFIED IN REGULATORY AGENCY PERMITS. MONITORING WOULD BE PERFORMED BY A BIOLOGIST OR BOTANIST FAMILIAR WITH PLANT SPECIES NATIVE TO CARMEL RIVER AND MONTEREY COUNTY
12. ALL WORK WOULD BE CONDUCTED IN ACCORDANCE WITH THESE SPECIFICATIONS OR AS OTHERWISE REQUIRED BY REGULATORY AGENCY PERMITS IN ORDER TO MEET ESTABLISHED SUCCESS CRITERIA FOR VEGETATION SURVIVAL AND COVER, AS APPLICABLE.

CONTAINER STOCK SPECIFICATIONS (DETAIL 1)

1. CONTAINER STOCK WILL BE INSTALLED BY HAND AND SUBJECT TO THE FOLLOWING CONDITIONS:
 - a) CONTAINER STOCK PLANT MATERIAL WILL BE PICKED UP NO MORE THAN FIVE DAYS PRIOR TO PLANTING.
 - b) ALL PLANTING HOLES SHALL BE DUG TO EQUAL THE DEPTH AND 1.5 TIMES THE WIDTH OF THE ROOTBALL OR RHIZOME.
 - c) 1/2 TABLESPOON OF 14-14-14 SLOW RELEASE FERTILIZER SHALL BE PLACED AT THE BOTTOM OF THE PLANTING HOLE.
 - d) THE PLANT WILL BE PLACED IN THE HOLE, THEN THE HOLE SHALL BE FILLED HALF-WAY WITH SOIL AND FIRMLY TAMPED AROUND THE ROOT BALL. THE PLANTING WILL THEN BE IRRIGATED. AFTER IRRIGATION, THE HOLE WILL BE COMPLETELY FILLED WITH SOIL THEN IRRIGATED A SECOND TIME.
 - e) AFTER THE SOIL HAS BEEN FIRMLY TAMPED AROUND THE ROOTBALL AND IRRIGATED, THE CROWN OF THE ROOTBALL SHALL BE AT THE SURROUNDING FINISH GRADE OF THE SLOPES.

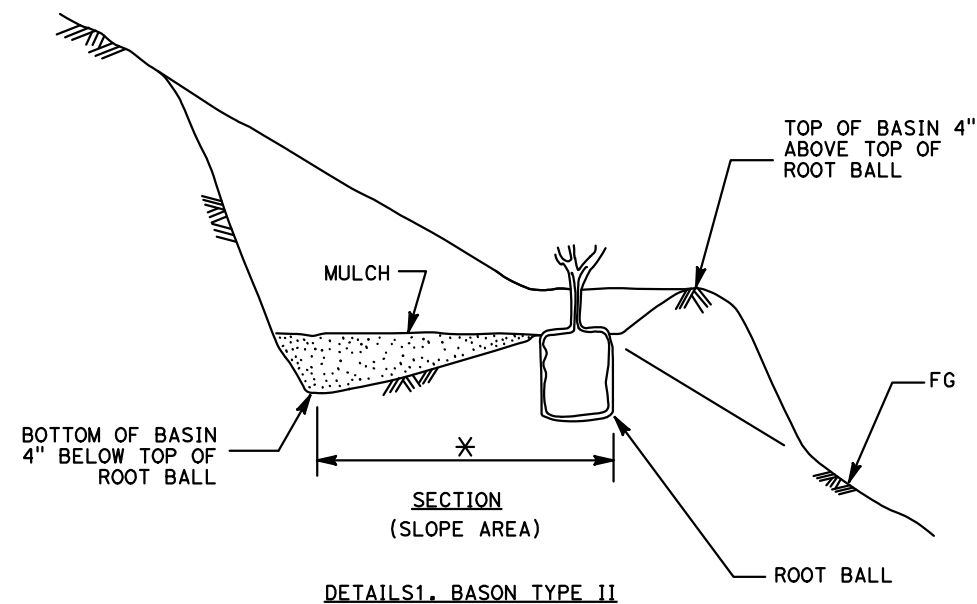

* BASIN AREA EQUIVALENT TO 12" DIA

Drawing name: C:\Projects\2021\151519 Robinson_Cyn_Rd\Draw\Sub\Revea_P-1.dwg Layout: Tab: P001 Sep 10 2021 3:45pm Davis_Horoff

Submitted by: M. IMBRIANI Design Engineer C.E. No. 36834	
DESIGN BY: C. STAPELMANN	CHKD BY:
DRAWN BY: M. ORNELAS-ZAMORES	CHKD BY:
SPECIFICATIONS WRITTEN BY:	CHKD BY:
Approval Recommended by: Deputy Public Works Director, Engineering	



1243 ALPINE RD SUITE 108
WALNUT CREEK, CA 94596



NO.	DATE	REVISION DESCRIPTION	APPROVED



COUNTY OF MONTEREY
DEPT. OF PUBLIC WORKS,
FACILITIES & PARKS
1441 SCHILLING PLACE
SALINAS, CALIFORNIA 93901
(831) 755-4800/FAX (831) 755-4958

ROBINSON CANYON ROAD BRIDGE SCOUR PROJECT PLANTING PLAN			
FEDERAL PROJECT NO. BHLO-5944(099) COUNTY BRDG NO. 503			
DATE 9-10-2021	FILE	PROJECT NO. 385165	SHEET 1
SCALE AS NOTED		CONTRACT NO.	
			OF 11 SHEETS

SHEET NUMBER	TOTAL SHEETS
14	23

APPENDIX V- PROJECT PLANS, SPECIFICATIONS AND ESTIMATE

- LEGEND:**
- INDICATES EXISTING STRUCTURE (OVERHEAD)
 - ~~~ INDICATES DIRECTION OF FLOW
 - ← INDICATES DIRECTION OF TRAFFIC
 - ① ARTICULATED CONCRETE BLOCK (ACB) MAT
 - ② NATIVE MATERIAL OVER RSP, TYP W/ WILLOW STAKES
 - ③ NATIVE BACKFILL MIXED W/ RSP
 -  LARGE WOODY DEBRIS – LOG SPURS W/ ROOT WADS, FOOTER LOG, ANCHOR STONES, AND 2' DIAMETER ROCK

- NOTES:**
1. ALL DIMENSIONS SHOWN ARE ±.
 2. FOR SECTIONS A-A AND B-B AND DETAIL C SEE "LARGE WOODY DEBRIS DETAILS NO. 2" SHEET
 3. FOR SECTIONS D-D AND E-E SEE "LARGE WOODY DEBRIS DETAILS NO. 3" SHEET



PLAN
1"=20'

C:\Projects\2013\15019_Robinson_Cyn_Rd\Drawings\Revs_P-2-4.dwg - 12/18/2021 - 12:18pm Davis-Horvath

P-2

Submitted by: C. SEWELL Design Engineer C.E. No. 64807	
DESIGN BY: J. ABRAMS	CHKD BY:
DRAWN BY: M. DU	CHKD BY:
SPECIFICATIONS WRITTEN BY:	CHKD BY:
Approval Recommended by: Deputy Public Works Director, Engineering	



1243 ALPINE RD SUITE 108
WALNUT CREEK, CA 94596



NO.	DATE	REVISION DESCRIPTION	APPROVED



COUNTY OF MONTEREY
DEPT. OF PUBLIC WORKS,
FACILITIES & PARKS

1441 SCHILLING PLACE
SALINAS, CALIFORNIA 93901
(831) 755-4800/FAX (831) 755-4958

ROBINSON CANYON ROAD BRIDGE SCOUR PROJECT			
LARGE WOODY DEBRIS DETAILS NO. 1			
FEDERAL PROJECT NO. BHLO-5944(099) COUNTY BRIDGE NO. 503			
DATE 09-10-21	FILE	PROJECT NO. 385165	SHEET 2
SCALE AS NOTED	CONTRACT NO.		OF 1 SHEETS

SHEET NUMBER	TOTAL SHEETS
15	23

ABBREVIATIONS:

ACB	ARTICULATED CONCRETE BLOCK
MAX	MAXIMUM
FG	FINISHED GROUND
OG	ORIGINAL GROUND
RSP	ROCK SLOPE PROTECTION
W/	WITH

NOTES:

1. FILL HOLE APPROXIMATELY 2/3 FULL WITH EPOXY AND INSERT CABLE INTO HOLE UNTIL IT REACHES BOTTOM.
2. CUT NOTCHES AT THE LOCATION WHERE THE ROOTWAD OVERLAPS THE HEADER LOGS TO ENSURE A STABLE JOINT.
3. ANCHOR STONES SHALL BE 3/4 TON ROCK.

APPENDIX V- PROJECT PLANS, SPECIFICATIONS AND ESTIMATE

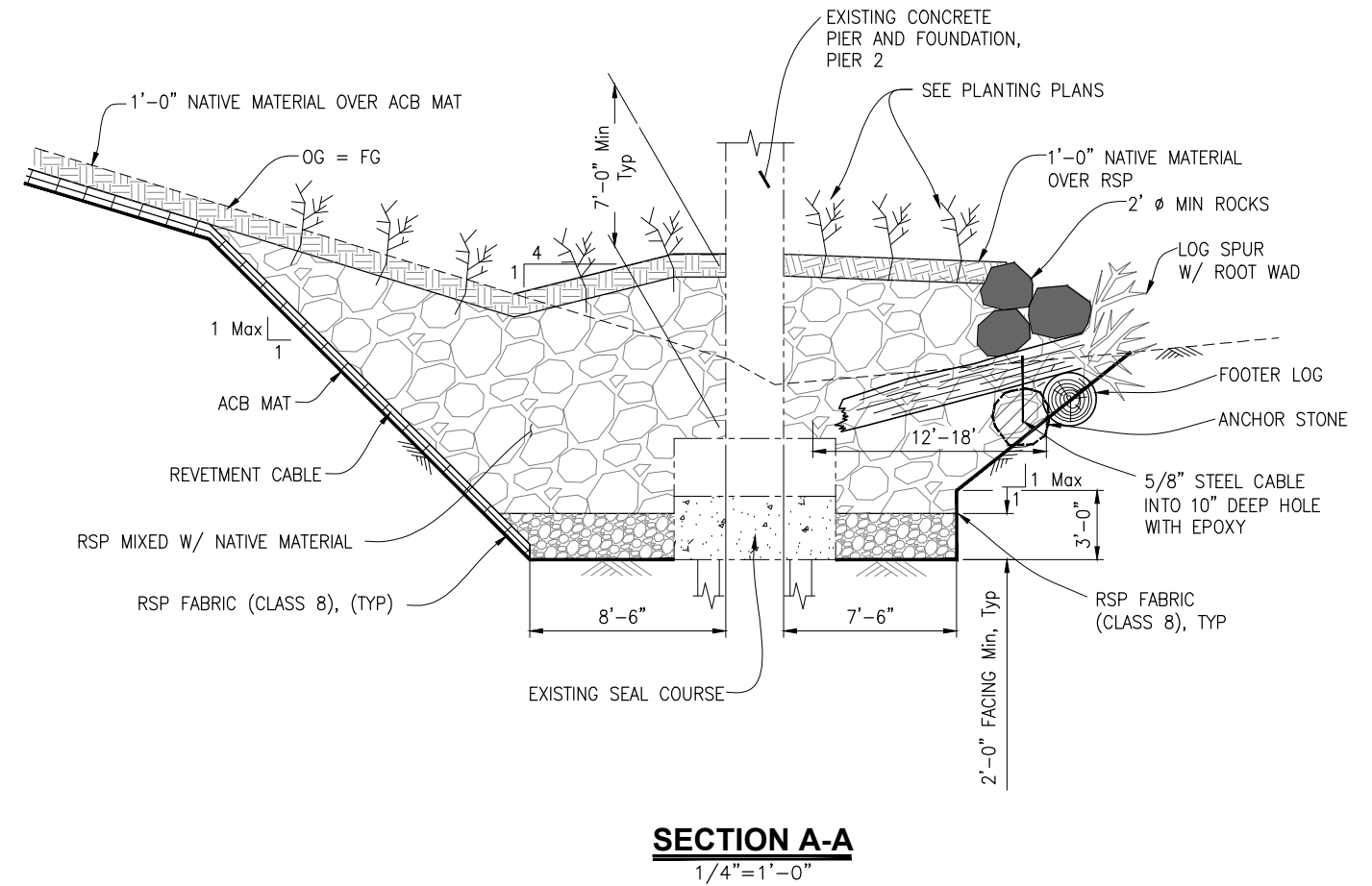
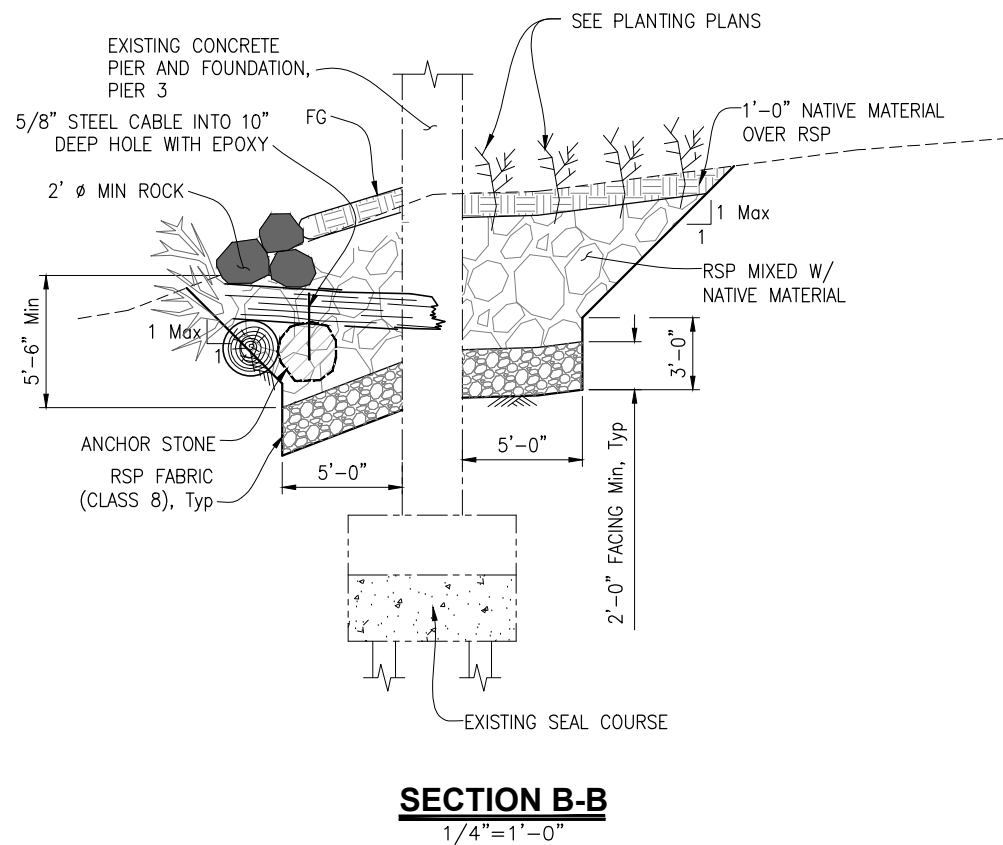
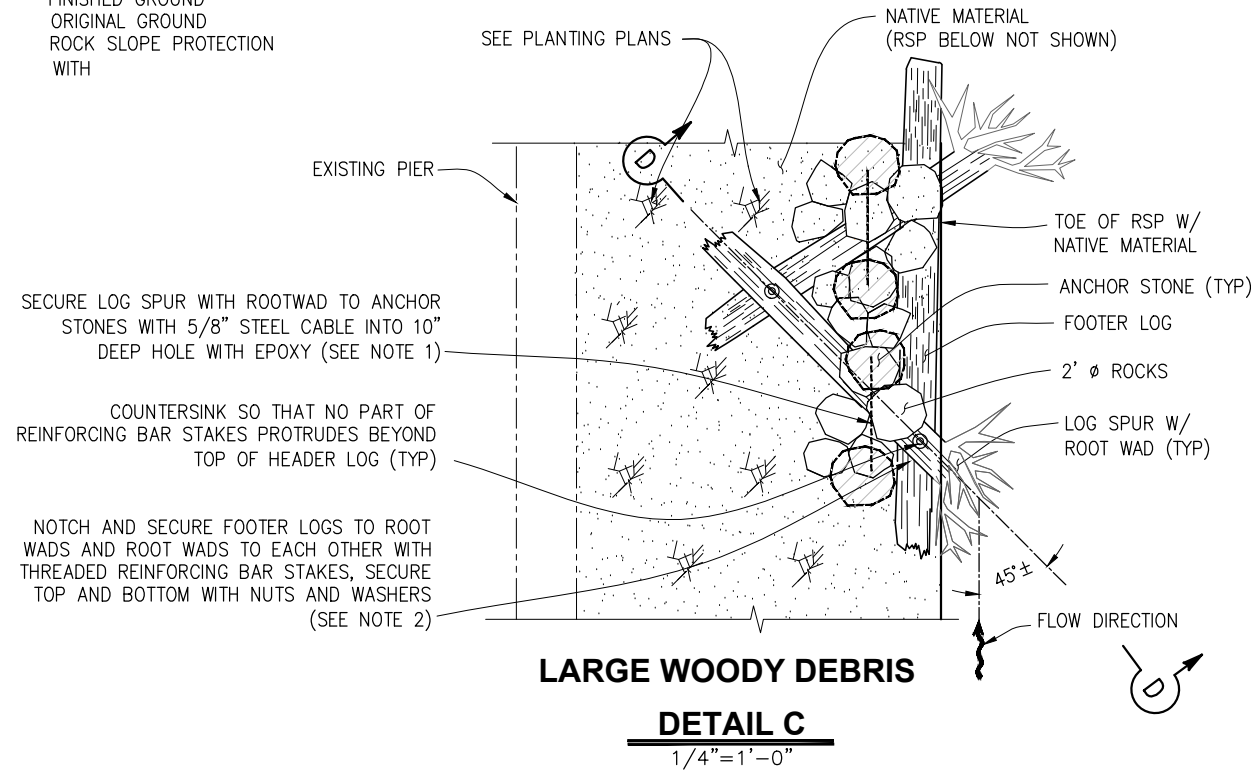

Submitted by: C. SEWELL Design Engineer C.E. No. 64807	
DESIGN BY: J. ABRAMS	CHKD BY:
DRAWN BY: M. DU	CHKD BY:
SPECIFICATIONS WRITTEN BY:	CHKD BY:
Approval Recommended by: Deputy Public Works Director, Engineering	

wreco

1243 ALPINE RD SUITE 108
WALNUT CREEK, CA 94596

ORIGINAL SCALE IN INCHES
FOR REDUCED PLANS

0 1 2 3

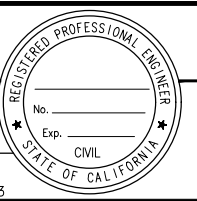

NO.	DATE	REVISION DESCRIPTION	APPROVED

COUNTY OF MONTEREY
DEPT. OF PUBLIC WORKS,
FACILITIES & PARKS

1441 SCHILLING PLACE
SALINAS, CALIFORNIA 93901
(831) 755-4800/FAX (831) 755-4958

ROBINSON CANYON ROAD BRIDGE SCOUR PROJECT LARGE WOODY DEBRIS DETAILS NO. 2			
FEDERAL PROJECT NO. BHLO-5944(099) COUNTY BRIDGE NO. 503			
DATE 09-10-21	FILE	PROJECT NO. 385165	SHEET 3
SCALE AS NOTED	CONTRACT NO.		OF 1 SHEETS

C:\Projects\2013\1515019_Robinson_Cyn_Road\Drawings\Revised_Plans_1-3.dwg Layout Tab: P-3 Sep 09 2021 - 2:25pm Davis-Horvath

APPENDIX V- PROJECT PLANS, SPECIFICATIONS AND ESTIMATE

SHEET NUMBER	TOTAL SHEETS
16	23

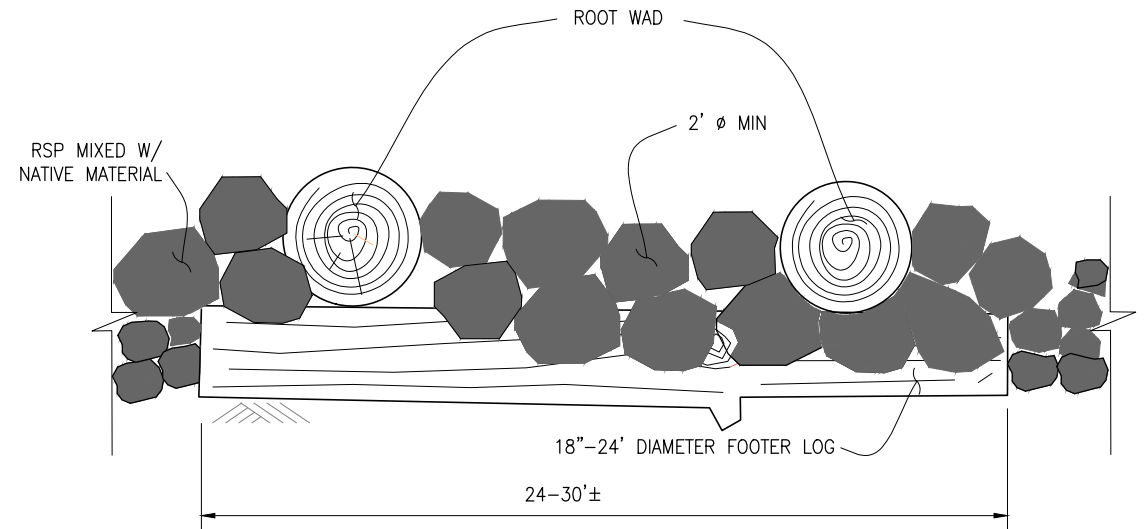
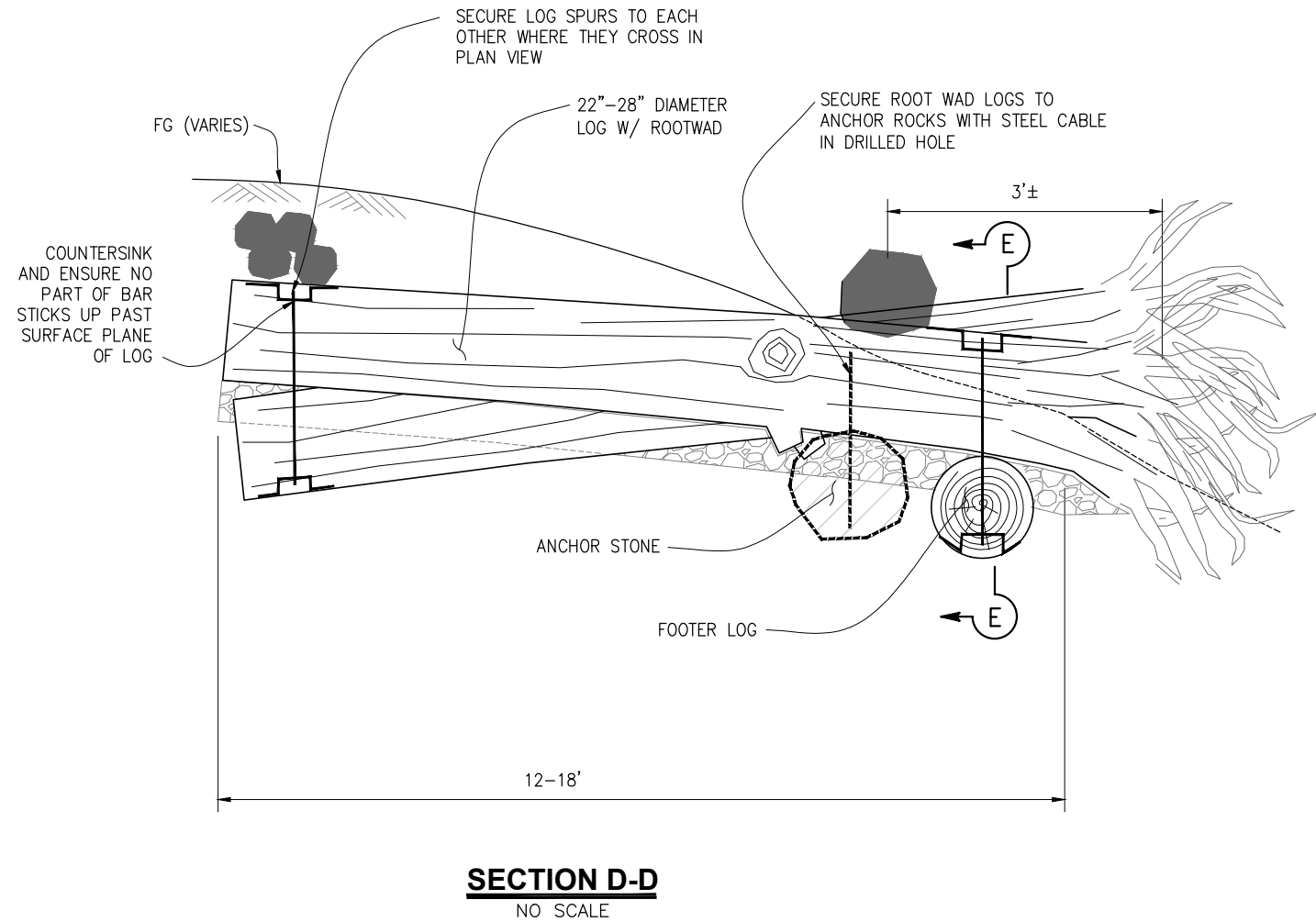

LARGE WOODY DEBRIS
SECTION E-E
NO SCALE

C:\Projects\2013\151519_ Robinson_Cyn_Rd\Drawings\Revsz_Plans_1-3.dwg Layout Tab: P-4 Sep 09, 2021 - 2:24pm Davis-Hirshiff

P-4

Submitted by: C. SEWELL Design Engineer C.E. No. 64807	
DESIGN BY: J. ABRAMS	CHKD BY:
DRAWN BY: M. DU	CHKD BY:
SPECIFICATIONS WRITTEN BY:	CHKD BY:
Approval Recommended by: _____ Deputy Public Works Director, Engineering	



1243 ALPINE RD SUITE 108
WALNUT CREEK, CA 94596



ORIGINAL SCALE IN INCHES
FOR REDUCED PLANS



NO.	DATE	REVISION DESCRIPTION	APPROVED







COUNTY OF MONTEREY
DEPT. OF PUBLIC WORKS,
FACILITIES & PARKS

1441 SCHILLING PLACE
SALINAS, CALIFORNIA 93901
(831) 755-4800/FAX (831) 755-4958







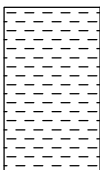

ROBINSON CANYON ROAD BRIDGE			
SCOUR PROJECT			
LARGE WOODY DEBRIS DETAILS NO.3			
FEDERAL PROJECT NO. BHLO-5944(099) COUNTY BRIDGE NO. 503			
DATE 09-10-21	FILE	PROJECT NO. 385165	SHEET 4
SCALE AS NOTED	CONTRACT NO.		OF 1 SHEETS

SHEET NUMBER	TOTAL SHEETS
17	23

ZONE 1 – CHANNEL/BANKS PLANT PALETTE (114 FT TO 117 FT)

SYMBOL	COMMON NAME	SCIENTIFIC NAME	CONTAINER SIZE	SPACING (FEET ON CENTER)	NUMBER OF PLANTS
TREES					
	WHITE ADLER	ALNUS RHOMBIFOLIA	5-GALLON TREEPOT	12	7
	SYCAMORE	PLATANUS RACEMOSA	5-GALLON TREEPOT	12	3
	BLACK COTTONWOOD	POPULUS TRICHOCARPA	5-GALLON TREEPOT	12	3
	RED WILLOW	SALIX LAEVIGATA	CUTTING	12	4
	ARROYO WILLOW	SALIX LASIOLEPS	CUTTING	8	3
SHRUBS					
	WESTERN GOLDENROD	EUTHAMIA OCCIDENTALIS	1-GALLON	2	FIELD FIT
	MUGWORT	ARTEMISIA DOUGLASIANA	PLUGS OR DEEPOTS	2	
	HORSETAIL	EQUISETUM ARVENSE	PLUGS OR DEEPOTS	2	

ZONE 2 – FLOODPLAIN PLANT PALETTE (117 FT TO 127 FT)

SYMBOL	COMMON NAME	SCIENTIFIC NAME	CONTAINER SIZE	SPACING (FEET ON CENTER)	NUMBER OF PLANTS
TREES					
	WHITE ADLER	ALNUS RHOMBIFOLIA	5-GALLON TREEPOT	12	3
	SYCAMORE	PLATANUS RACEMOSA	5-GALLON TREEPOT	12	1
	BLACK COTTONWOOD	POPULUS TRICHOCARPA	5-GALLON TREEPOT	12	1
	RED WILLOW	SALIX LAEVIGATA	CUTTING	12	3
	ARROYO WILLOW	SALIX LASIOLEPS	CUTTING	8	2
SHRUBS					
	CALIFORNIA BLACKBERRY	RUBUS URSINUS	1-GALLON	6	4
	BLUE ELDERBERRY	SAMBUCUS NIGRA	1-GALLON	6	3
	SNOWBERRY	SYMPHORICARPOS MOLLIS	1-GALLON	6	2
VINE					
	CLEMATIS	CLEMATIS LIGUSTICIFOLIA	1-GALLON	6	1

Drawing name: C:\Projects\2021\151519 Robinson_Cyn_Rd\Drawings\Reveg_P-5-11.dwg Sep 10 2021 3:47pm Davis, Hovell

Submitted by: **M. IMBRIANI**
Design Engineer C.E. No. 36634

DESIGN BY: **C. STAPELMANN** CHKD BY: _____

DRAWN BY: **M. ORNELAS-ZAMORES** CHKD BY: _____

SPECIFICATIONS WRITTEN BY: _____ CHKD BY: _____

Approval Recommended by: _____
Deputy Public Works Director, Engineering



1243 ALPINE RD SUITE 108
WALNUT CREEK, CA 94596



ORIGINAL SCALE IN INCHES FOR REDUCED PLANS

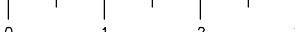

NO.	DATE	REVISION DESCRIPTION	APPROVED



COUNTY OF MONTEREY
DEPT. OF PUBLIC WORKS,
FACILITIES & PARKS

1441 SCHILLING PLACE
SALINAS, CALIFORNIA 93901
(831) 755-4800/FAX (831) 755-4958

**ROBINSON CANYON ROAD BRIDGE
SCOUR PROJECT
PLANTING PLAN**









FEDERAL PROJECT NO. BHLO-5944(099) COUNTY BRDG NO. 503

DATE 9-10-2021	FILE	PROJECT NO. 385165	SHEET 5
SCALE AS NOTED		CONTRACT NO.	





OF 11 SHEETS

SHEET NUMBER	TOTAL SHEETS
18	23

ZONE 3 – UPPER FLOODPLAIN/UPLAND PLANT PALETTE (127 FT TO TOP OF BANK)

SYMBOL	COMMON NAME	SCIENTIFIC NAME	CONTAINER SIZE	SPACING (FEET ON CENTER)	NUMBER OF PLANTS
TREES					
	SYCAMORE	PLATANUS RACEMOSA	5-GALLON TREEPOT	12	2
	BLACK COTTONWOOD	POPULUS TRICHOCARPA	5-GALLON TREEPOT	12	2
	COAST LIVE OAK	QUERCUS AGRIFOLIA	5-GALLON TREEPOT	12	3
	CALIFORNIA BAY	UMBELLULARIA CALIFORNICA	5-GALLON TREEPOT	12	1
SHRUBS					
	SPREADING GOOSEBERRY	RIBES DIVARICATUM	1-GALLON	6	5
	CALIFORNIA BLACKBERRY	RUBUS URSINUS	1-GALLON	6	6
	BLUE ELDERBERRY	SAMBUCUS NIGRA	1-GALLON	6	3
	SNOWBERRY	SYMPHORICARPOS MOLLIS	1-GALLON	6	4
VINE					
	CLEMATIS	CLEMATIS LIGUSTICIFOLIA	1-GALLON	6	3

ZONE 4 – ROCK SLOPE PROTECTION PLANT PALETTE

SYMBOL	COMMON NAME	SCIENTIFIC NAME	CONTAINER SIZE	SPACING (FEET ON CENTER)	NUMBER OF PLANTS
TREES					
	ARROYO WILLOW	SALIX LASIOLEPS	CUTTING	8	28
SHRUBS					
	CALIFORNIA BLACKBERRY	RUBUS URSINUS	1-GALLON	6	22
	SNOWBERRY	SYMPHORICARPOS MOLLIS	1-GALLON	6	12
VINE					
	CLEMATIS	CLEMATIS LIGUSTICIFOLIA	1-GALLON	6	10

ZONE 5 – ARTICULATED CONCRETE BLOCK PLANT PALETTE

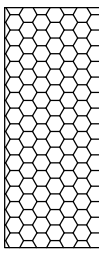
SYMBOL	COMMON NAME	SCIENTIFIC NAME	CONTAINER SIZE	SPACING (FEET ON CENTER)	NUMBER OF PLANTS
	MUGWORT	ARTEMISIA DOUGLASIANA	PLUGS	3	FIELD FIT
	CLEMATIS	CLEMATIS LIGUSTICIFOLIA	PLUGS	3	
	CALIFORNIA BLACKBERRY	RUBUS URSINUS	PLUGS	3	
	SNOWBERRY	SYMPHORICARPOS MOLLIS	PLUGS	3	

Drawing name: C:\Projects\2021\151519 Robinson_Cyn_Rd\Drawings\Reveg_P-5-11.dwg Layout Tab: P-6 Sep 10 2021 3:46pm Davis, Horeff

Submitted by: **M. IMBRIANI**
Design Engineer C.E. No. 36634

DESIGN BY: **C. STAPELMANN** CHKD BY:

DRAWN BY: **M. ORNELAS-ZAMORES** CHKD BY:

SPECIFICATIONS WRITTEN BY: CHKD BY:

Approval Recommended by: _____
Deputy Public Works Director, Engineering



1243 ALPINE RD SUITE 108
WALNUT CREEK, CA 94596



ORIGINAL SCALE IN INCHES
FOR REDUCED PLANS



NO.	DATE	REVISION DESCRIPTION	APPROVED



COUNTY OF MONTEREY
DEPT. OF PUBLIC WORKS,
FACILITIES & PARKS

1441 SCHILLING PLACE
SALINAS, CALIFORNIA 93901
(831) 755-4800/FAX (831) 755-4958

**ROBINSON CANYON ROAD BRIDGE
SCOUR PROJECT
PLANTING PLAN**

FEDERAL PROJECT NO. BHLO-5944(099) COUNTY BRDG NO. 503

DATE 9-10-2021	FILE	PROJECT NO. 385165	SHEET 6
SCALE AS NOTED		CONTRACT NO.	

OF 11 SHEETS

SEED MIX – RIPARIAN & ROCK SLOPE PROTECTION

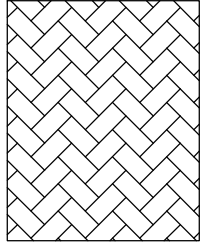
SYMBOL	COMMON NAME	SCIENTIFIC NAME	POUNDS PLS PER ACRE
	MUGWORT	ARTEMISIA DOUGLASIANA	2.0
	TUFTED HAIRGRASS	DESCHAMPSIA CAESPITOSA	0.75
	CREEPING WILDRYE	ELYMUS TRITICOIDES	10.0
	CALIFORNIA POPPY	ESCHSCHOLZIA CALIFORNICA	0.25
	SMALL FESCUE	FESTUCA MICROSTACHYS	1.0
	MEADOW BARLEY	HORDEUM BRACHYENTHERUM	10.0

SEED MIX – UPLAND

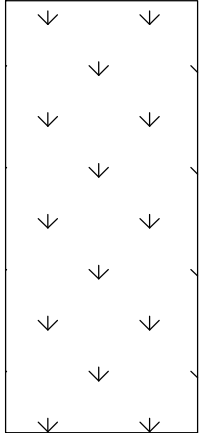
SYMBOL	COMMON NAME	SCIENTIFIC NAME	POUNDS PLS PER ACRE
	WESTERN YARROW	ACHILLEA	0.25
	DEERWEED	ACMISPON GLABER	0.5
	MUGWORT	ARTEMISIA DOUGLASIANA	1.0
	CALIFORNIA BROME	BROMUS CARINATUS	8.0
	BLUE WILDRYE	ELYMUS GLAUCUS	6.0
	CALIFORNIA POPPY	ESCHSCHOLZIA CALIFORNICA	1.25
	MEADOW BARLEY	HORDEUM BRACHYENTHERUM	8.0
	BICOLORED LUPINE	LUPINUS BICOLOR	5.0
	MELIC GRASS	MELICA IMPERFECTA	1.5
	PURPLE NEEDLEGRASS	STIPA PULCHRA	9.0

Drawing name: C:\Projects\2021\151919_Robinson_Cyn_Rd\Drawings\Revs\ P-5-11.dwg Layout Tab: P-7 Sep 10/2021 3:47pm Davis-Horvath

Submitted by: **M. IMBRIANI**
Design Engineer C.E. No. 36634

DESIGN BY: **C. STAPELMANN** CHKD BY:

DRAWN BY: **M. ORNELAS-ZAMORES** CHKD BY:

SPECIFICATIONS WRITTEN BY: CHKD BY:

Approval Recommended by: _____
Deputy Public Works Director, Engineering



1243 ALPINE RD SUITE 108
WALNUT CREEK, CA 94596



ORIGINAL SCALE IN INCHES FOR REDUCED PLANS



NO.	DATE	REVISION DESCRIPTION	APPROVED



COUNTY OF MONTEREY
DEPT. OF PUBLIC WORKS,
FACILITIES & PARKS

1441 SCHILLING PLACE
SALINAS, CALIFORNIA 93901
(831) 755-4800/FAX (831) 755-4958

**ROBINSON CANYON ROAD BRIDGE
SCOUR PROJECT
PLANTING PLAN**

FEDERAL PROJECT NO. BHLO-5944(099) COUNTY BRDG NO. 503

DATE 9-10-2021	FILE	PROJECT NO. 385165	SHEET 7
SCALE AS NOTED	CONTRACT NO.		OF 11 SHEETS

APPENDIX V- PROJECT PLANS, SPECIFICATIONS AND ESTIMATE

SHEET NUMBER	TOTAL SHEETS
20	23

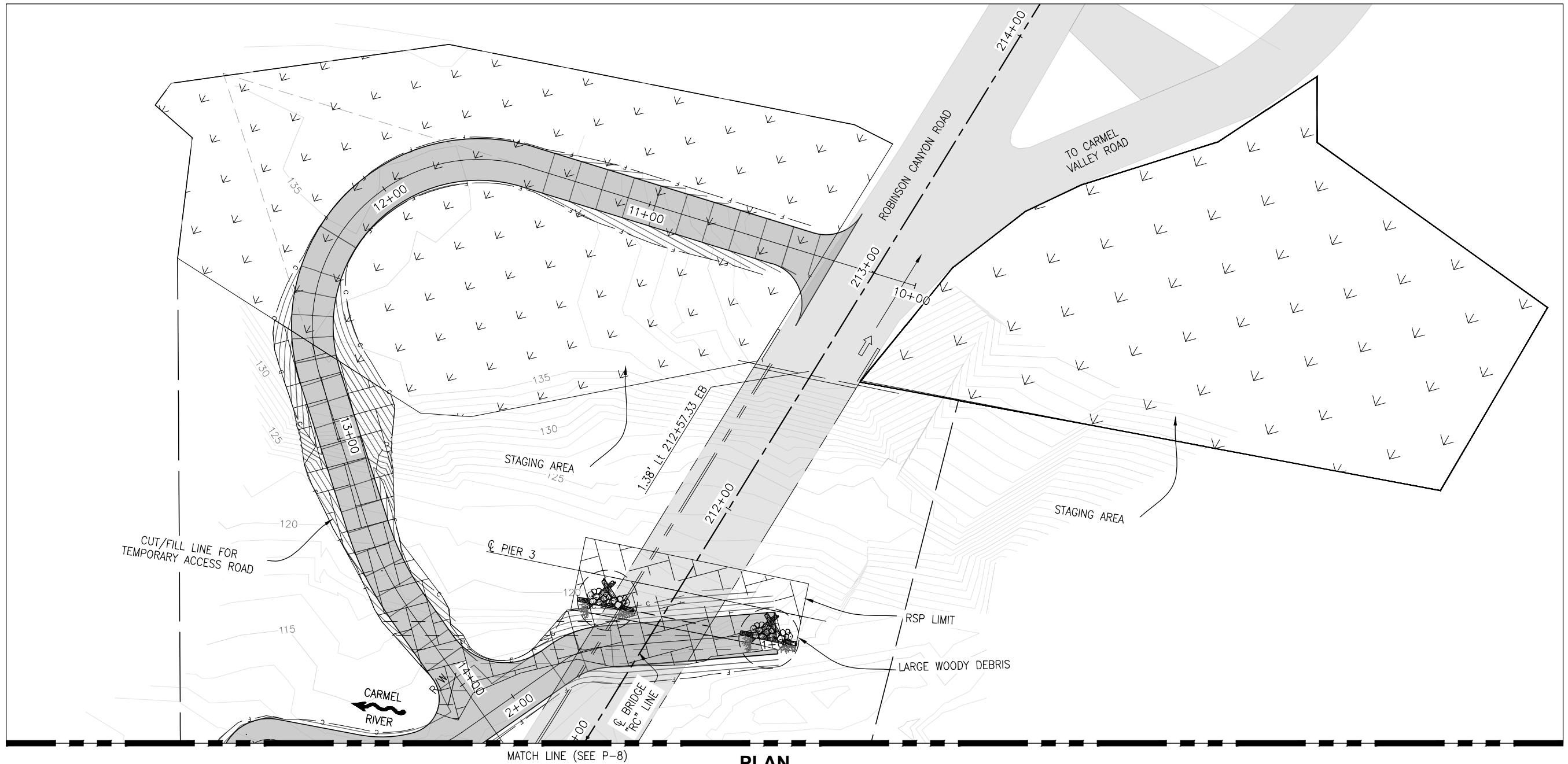

PLAN
1"=20'

- LEGEND:**
- INDICATES EXISTING STRUCTURE (OVERHEAD)
 - INDICATES DIRECTION OF FLOW
 - INDICATES DIRECTION OF TRAFFIC



LARGE WOODY DEBRIS - LOG SPURS W/ ROOT WADS, FOOTER LOG, ANCHOR STONES, AND 2" DIAMETER ROCK



RIPARIAN & RSP SEED MIX (SEE P-6)

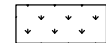

UPLAND SEED MIX (SEE P-6)

NOTES:

1. ALL DIMENSIONS SHOWN ARE ±.

Submitted by: M. IMBRIANI Design Engineer C.E. No. 36634	
DESIGN BY: C. STAPELMANN	CHKD BY:
DRAWN BY: M. ORNELAS-ZAMORES	CHKD BY:
SPECIFICATIONS WRITTEN BY:	CHKD BY:
Approval Recommended by: Deputy Public Works Director, Engineering	

1243 ALPINE RD SUITE 108
WALNUT CREEK, CA 94596

ORIGINAL SCALE IN INCHES
FOR REDUCED PLANS

0 1 2 3

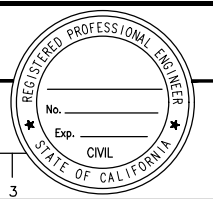

NO.	DATE	REVISION DESCRIPTION	APPROVED
△			
△			
△			
△			
△			



COUNTY OF MONTEREY
DEPT. OF PUBLIC WORKS,
FACILITIES & PARKS

1441 SCHILLING PLACE
SALINAS, CALIFORNIA 93901
(831) 755-4800/FAX (831) 755-4958

ROBINSON CANYON ROAD BRIDGE SCOUR PROJECT PLANTING PLAN			
FEDERAL PROJECT NO. BHLO-5944(099) COUNTY BRDG NO. 503			
DATE 9-10-2021	FILE	PROJECT NO. 385165	SHEET 8
SCALE AS NOTED	CONTRACT NO.		OF 11 SHEETS

APPENDIX V- PROJECT PLANS, SPECIFICATIONS AND ESTIMATE

SHEET NUMBER	TOTAL SHEETS
21	23

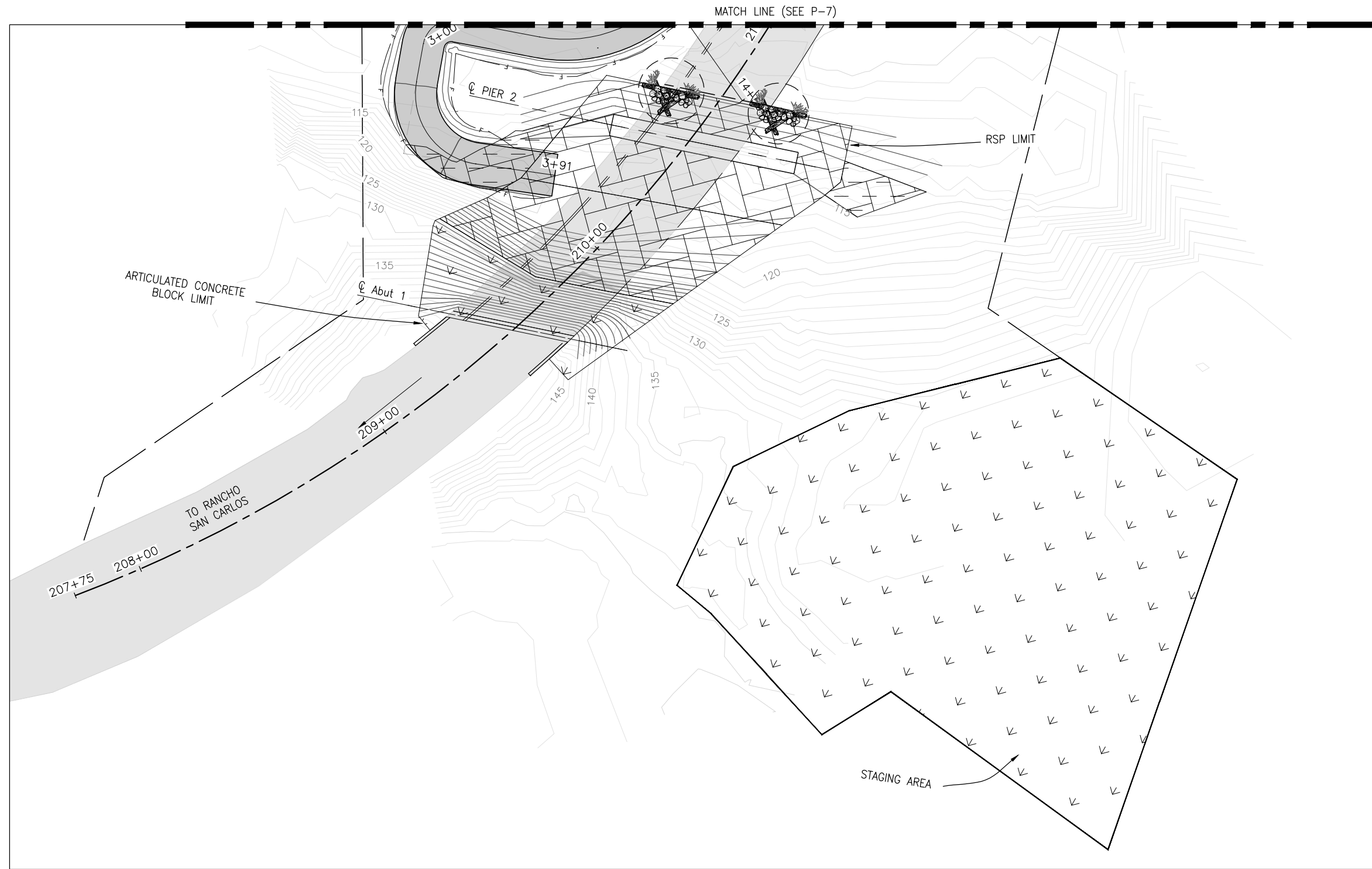

- LEGEND:**
- INDICATES EXISTING STRUCTURE (OVERHEAD)
 - INDICATES DIRECTION OF FLOW
 - INDICATES DIRECTION OF TRAFFIC



LARGE WOODY DEBRIS - LOG SPURS W/ ROOT WADS, FOOTER LOG, ANCHOR STONES, AND 2" DIAMETER ROCK



RIPARIAN & RSP SEED MIX (SEE P-6)



UPLAND SEED MIX (SEE P-6)

PLAN
1"=20'

NOTES:

1. All DIMENSIONS SHOWN ARE ±.

Drawing name: G:\Projects\2015\1515019 Robinson_Cm_BA\Drawings\Revised_P-5-11.dwg Layout Tab: P-9 Sep 10 2021 - 3:50pm Davis Herriff

Submitted by: M. IMBRIANI Design Engineer C.E. No. 36634	
DESIGN BY: C. STAPELMANN	CHKD BY:
DRAWN BY: M. ORNELAS-ZAMORES	CHKD BY:
SPECIFICATIONS WRITTEN BY:	CHKD BY:
Approval Recommended by: Deputy Public Works Director, Engineering	

1243 ALPINE RD SUITE 108
WALNUT CREEK, CA 94596

ORIGINAL SCALE IN INCHES
FOR REDUCED PLANS

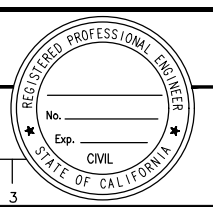

NO.	DATE	REVISION DESCRIPTION	APPROVED

COUNTY OF MONTEREY
DEPT. OF PUBLIC WORKS,
FACILITIES & PARKS

1441 SCHILLING PLACE
SALINAS, CALIFORNIA 93901
(831) 755-4800/FAX (831) 755-4958

ROBINSON CANYON ROAD BRIDGE SCOUR PROJECT PLANTING PLAN			
FEDERAL PROJECT NO. BHLO-5944(099) COUNTY BRDG NO. 503			
DATE 9-10-2021	FILE	PROJECT NO. 385165	SHEET 9
SCALE AS NOTED	CONTRACT NO.		OF 11 SHEETS

APPENDIX V- PROJECT PLANS, SPECIFICATIONS AND ESTIMATE

SHEET NUMBER	TOTAL SHEETS
22	23

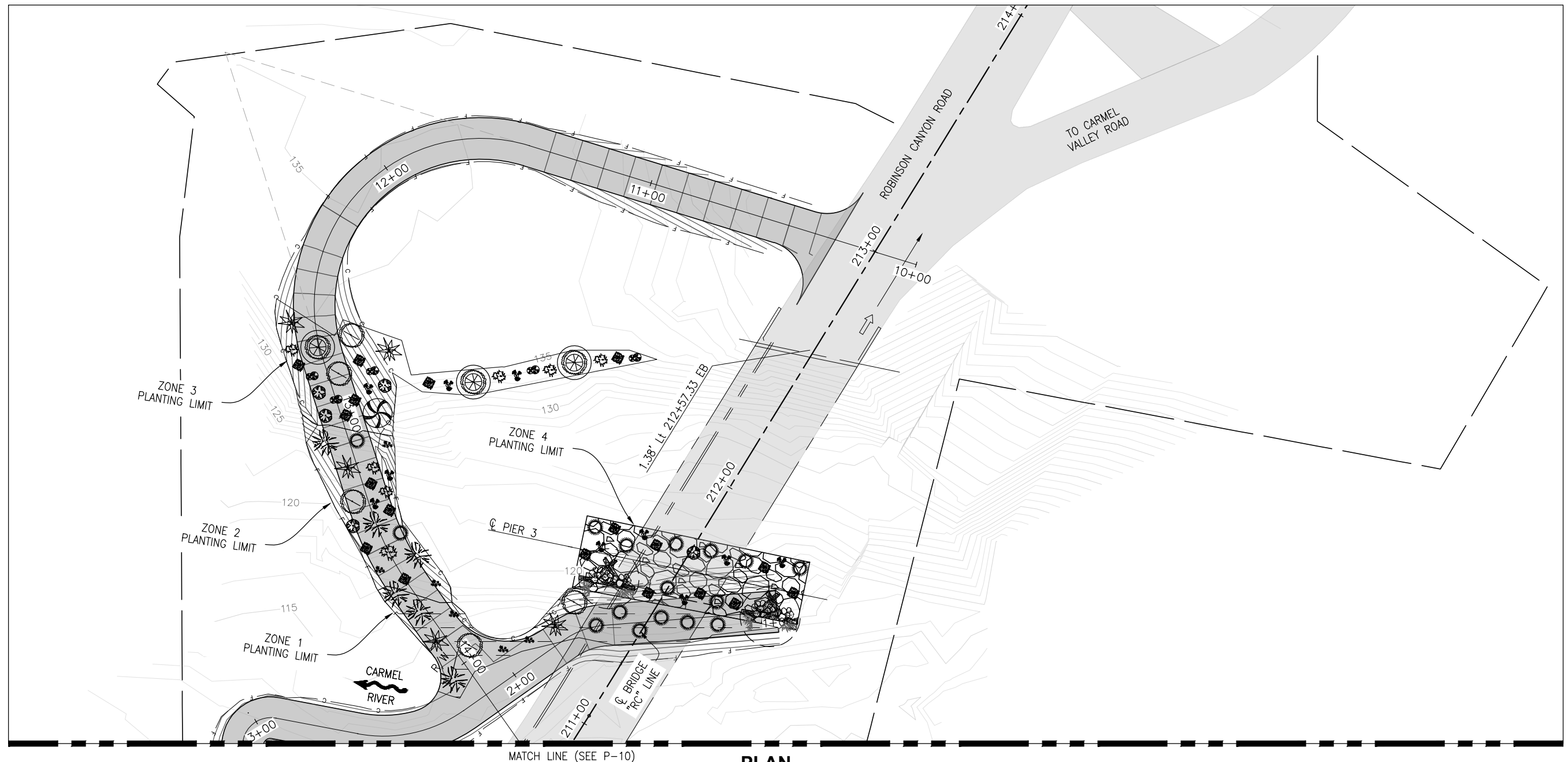

PLAN
1"=20'

LEGEND:

- INDICATES EXISTING STRUCTURE (OVERHEAD)
- INDICATES DIRECTION OF FLOW
- INDICATES DIRECTION OF TRAFFIC
- LARGE WOODY DEBRIS - LOG SPURS W/ ROOT WADS, FOOTER LOG, ANCHOR STONES, AND 2' DIAMETER ROCK
- ZONE 1 PLANTING PALETTE (SEE P-4)
- PLANTING ZONE BOUNDARIES (ZONE 1, 2, 3, and 4; SEE P-4 AND P-5)
- ZONE 5 - ARTICULATED CONCRETE BLOCK PLANT PALETTE (SEE P-5)

NOTES:

1. ALL DIMENSIONS SHOWN ARE ±.

P-10

Submitted by: M. IMBRIANI Design Engineer C.E. No. 36634	
DESIGN BY: C. STAPELMANN	CHKD BY:
DRAWN BY: M. ORNELAS-ZAMORES	CHKD BY:
SPECIFICATIONS WRITTEN BY:	CHKD BY:
Approval Recommended by: Deputy Public Works Director, Engineering	

1243 ALPINE RD SUITE 108
WALNUT CREEK, CA 94596

ORIGINAL SCALE IN INCHES
FOR REDUCED PLANS

0 1 2 3

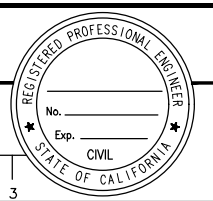

NO.	DATE	REVISION DESCRIPTION	APPROVED
△			
△			
△			
△			
△			



COUNTY OF MONTEREY
DEPT. OF PUBLIC WORKS,
FACILITIES & PARKS

1441 SCHILLING PLACE
SALINAS, CALIFORNIA 93901
(831) 755-4800/FAX (831) 755-4958

ROBINSON CANYON ROAD BRIDGE SCOUR PROJECT PLANTING PLAN			
FEDERAL PROJECT NO. BHLO-5944(099) COUNTY BRDG NO. 503			
DATE 9-10-2021	FILE	PROJECT NO. 385165	SHEET 10
SCALE AS NOTED	CONTRACT NO.		OF 11 SHEETS

APPENDIX V- PROJECT PLANS, SPECIFICATIONS AND ESTIMATE

SHEET NUMBER	TOTAL SHEETS
23	23

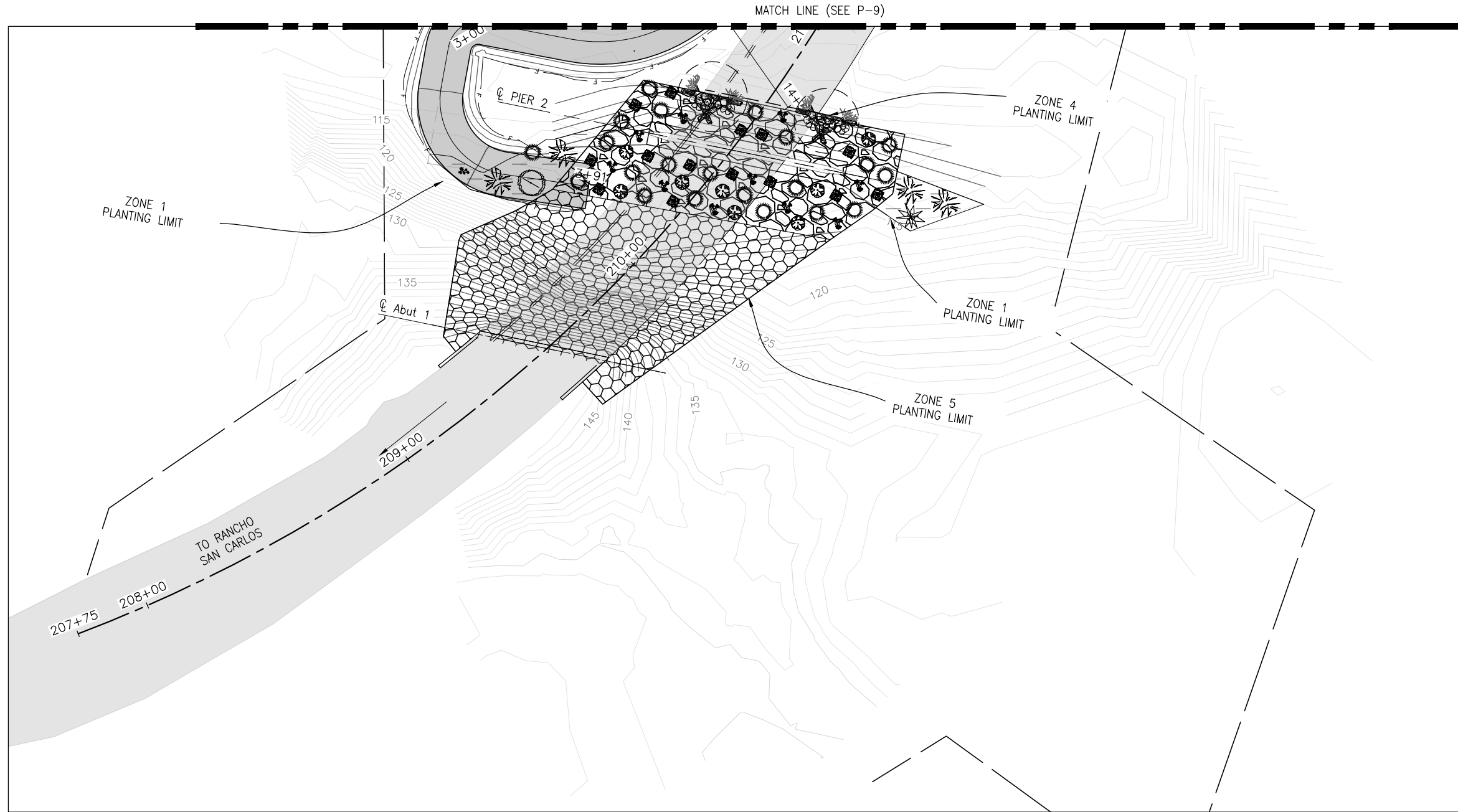

PLAN
1"=20'

LEGEND:

- INDICATES EXISTING STRUCTURE (OVERHEAD)
- INDICATES DIRECTION OF FLOW
- INDICATES DIRECTION OF TRAFFIC



LARGE WOODY DEBRIS – LOG SPURS W/ ROOT WADS, FOOTER LOG, ANCHOR STONES, AND 2' DIAMETER ROCK

- ZONE 1 PLANTING PALETTE (SEE P-4)
- PLANTING ZONE BOUNDARIES (ZONE 1, 2, 3, and 4; SEE P-4 AND P-5)
- ZONE 5 – ARTICULATED CONCRETE BLOCK PLANT PALETTE (SEE P-5)

NOTES:

1. ALL DIMENSIONS SHOWN ARE ±.

P-11

Submitted by: M. IMBRIANI Design Engineer C.E. No. 36634	
DESIGN BY: C. STAPELMANN	CHKD BY:
DRAWN BY: M. ORNELAS-ZAMORES	CHKD BY:
SPECIFICATIONS WRITTEN BY:	CHKD BY:
Approval Recommended by: Deputy Public Works Director, Engineering	

1243 ALPINE RD SUITE 108
WALNUT CREEK, CA 94596

ORIGINAL SCALE IN INCHES FOR REDUCED PLANS

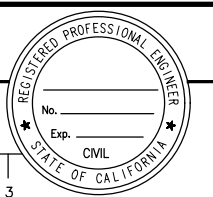

NO.	DATE	REVISION DESCRIPTION	APPROVED

COUNTY OF MONTEREY
DEPT. OF PUBLIC WORKS,
FACILITIES & PARKS

1441 SCHILLING PLACE
SALINAS, CALIFORNIA 93901
(831) 755-4800/FAX (831) 755-4958

ROBINSON CANYON ROAD BRIDGE SCOUR PROJECT PLANTING PLAN			
FEDERAL PROJECT NO. BHLO-5944(099) COUNTY BRDG NO. 503			
DATE 9-10-2021	FILE	PROJECT NO. 385165	SHEET 11
SCALE AS NOTED		CONTRACT NO.	
OF 11 SHEETS			

Drawing name: G:\Projects\2015\15019 Robinson_Cyn_Rd\Drawings\Revs P-5-11.dwg Layout Tab: P-11 Sep 10 2021 3:54pm Davis_Horeff