

Exhibit G

This page intentionally left blank.



River View at Las Palmas Assisted Living Senior Facility Project

Augmentation to the Final Subsequent
Environmental Impact Report
State Clearinghouse Number: 2017031025

prepared by

County of Monterey

Housing and Community Development Department

1441 Schilling Place, 2nd Floor

Salinas, California 93901

Contact: Zoe Zepp, Assistant Planner

prepared with the assistance of

Rincon Consultants, Inc.

80 Garden Court, Suite 240

Monterey, California 93940

September 2023



RINCON CONSULTANTS, INC.

Environmental Scientists | Planners | Engineers

rinconconsultants.com

River View at Las Palmas Assisted Living Senior Facility Project

Augmentation to the Final Subsequent
Environmental Impact Report

State Clearinghouse Number: 2017031025

prepared by

County of Monterey

Housing and Community Development Department

1441 Schilling Place, 2nd Floor

Salinas, California 93901

Contact: Zoe Zepp, Assistant Planner

prepared with the assistance of

Rincon Consultants, Inc.

80 Garden Court, Suite 240

Monterey, California 93940

September 2023



RINCON CONSULTANTS, INC.

Environmental Scientists | Planners | Engineers

rinconconsultants.com

Table of Contents

1	Introduction	1
1.1	Project Background	1
1.2	Augmentation to the Final Subsequent Environmental Impact Report	2
2	Additional Amendments to the Draft SEIR	4
4.0	Project Description.....	4
4.1	Project Objectives	4
17.0	Alternatives.....	5
17.1	CEQA Requirements	5
17.2	Alternatives Considered	5
17.3	Alternatives Considered But Rejected	21
17.4	Comparison of Alternatives.....	21
18.0	Sources.....	22

Tables

Table 17-1	Estimated Construction Emissions of Alternative 2	7
Table 17-2	Estimated Operational Emissions of Alternative 2.....	8
Table 17-3	Estimated Construction Emissions of Alternative 3a	11
Table 17-4	Estimated Operational Emissions of Alternative 3a.....	12
Table 17-5	Estimated Construction Emissions of Alternative 3b.....	15
Table 17-6	Estimated Operational Emissions of Alternative 3b	16
Table 17-7	Estimated Construction Emissions of Alternative 4	19
Table 17-8	Estimated Operational Emissions of Alternative 4.....	19
Table 17-9	Project Alternatives Summary.....	21

Appendices

Appendix A	CalEEMod Modeling Output
Appendix B	Traffic Impact Analysis

This page intentionally left blank.

1 Introduction

This Augmentation to the Final Subsequent Environmental Impact Report (Augmentation to the Final SEIR) has been prepared by the County of Monterey Housing and Community Development Department (County) for the proposed River View at Las Palmas Assisted Living Senior Facility Project (“proposed project” or “project”).

1.1 Project Background

Proposed Project

The project, as originally proposed and analyzed under the California Environmental Quality Act (CEQA), would consist of an approximately 120,000 square-foot senior assisted living facility with multiple structures and site improvements on an approximately 15.64-acre project site in unincorporated Monterey County. The project site is located south of River Road, approximately 0.5 mile east of State Route (SR) 68 and immediately north of existing residential development along Woodridge Court and Country Park Road. The proposed project would provide assisted living facilities for seniors requiring varying levels of assistance, and would include a 27,000-square foot, two-story assisted living facility; a 21,600-square foot, three-story memory care facility; and 13 “Casitas”, single-story residential structures providing 26 separate housing units. The proposed project would also include construction of internal roadways and parking, utility connections, landscaping, and other site improvements. The proposed project would have a total site coverage of approximately 190,000 square feet (27.6 percent of the project site).

Previous Project CEQA Review

The County issued a Notice of Preparation of a EIR in March 2017 for the proposed project, and an EIR was prepared for the project on behalf of the applicant. The County assumed control of the processing and content of this EIR, and the Draft Subsequent EIR (Draft SEIR) was released for public review in March 2018.¹ The County received 118 comment letters on the Draft SEIR; responses to comments were prepared pursuant to *CEQA Guidelines* Sections 15088 and 15132, and a Final SEIR was prepared in late 2019. The Monterey County Planning Commission recommended certification of the Final SEIR on February 12, 2020; however, the Final SEIR was not certified by the Board of Supervisors when it was considered at the August 31, 2021 or October 12, 2021 hearings. The September 2019 Final SEIR is herein incorporated by reference,² and would require certification by the Board of Supervisors alongside consideration of this Augmentation to the Final SEIR.

Alternative to the Proposed Project

Pursuant to *CEQA Guidelines* Section 15126.6, the applicant has prepared an alternative proposal to the project. As directed by the Monterey County Board of Supervisors on October 12, 2021, the project alternative includes development of a residential subdivision with up to 30 lots instead of the originally proposed senior assisted living facility (30-Lot Subdivision Alternative). This alternative

¹ The Draft Subsequent EIR is a supplement to the Final EIR for the River Road Area of Development Concentration Incorporating the Las Palmas Ranch Specific Plan Final EIR, certified in December 1982.

² <https://www.co.monterey.ca.us/government/departments-a-h/housing-community-development/planning-services/library-current-major-projects/river-view-at-las-palmas-assisted-living-senior-facility>

to the proposed project is similar to an alternative analyzed in the Draft SEIR, which considered a 40-lot residential subdivision alternative (Alternative 3 of the Draft SEIR).

1.2 Augmentation to the Final Subsequent Environmental Impact Report

Purpose of this Augmentation to the Final SEIR

To fully evaluate the potential environmental impacts of the new alternative to the proposed project, the County has prepared this Augmentation to the Final SEIR which incorporates the 30-Lot Subdivision Alternative into the alternatives analysis of the Draft SEIR. The 30-Lot Subdivision Alternative is included as Alternative 3b in the following revised alternatives analysis. In addition to incorporating this alternative into the analysis of the Draft SEIR, this Augmentation to the Final SEIR also includes minor clarifications and revisions to the analysis of the other alternatives to the proposed project. These clarifications and revisions incorporate quantitative modeling outputs that estimate air quality and greenhouse gas (GHG) emissions associated with each alternative to better compare the potential impacts associated with each alternative. These clarifications and revisions clarify and amplify analysis presented in the Draft SEIR and do not represent significant new information.

Contents of this Augmentation to the Final SEIR

This Augmentation to the Final SEIR includes the following contents:

- Section 1: Introduction
- Section 2: Additional Amendments to the Draft SEIR
- Appendices

Draft SEIR Recirculation Not Required

CEQA Guidelines Section 15088.5 requires recirculation when comments on a Draft EIR or responses thereto identify “significant new information.” Significant new information is defined as including:

1. A new significant environmental impact would result from the project or from a new mitigation measure proposed to be implemented.
2. A substantial increase in the severity of an environmental impact would result unless mitigation measures are adopted that reduce the impact to a level of insignificance.
3. A feasible project alternative or mitigation measure considerably different from others previously analyzed would clearly lessen the significant environmental impacts of the project, but the project's proponents decline to adopt it.
4. The Draft EIR was so fundamentally and basically inadequate and conclusory in nature that meaningful public review and comment were precluded.

The quantitative modeling outputs and amendments presented in this document do not constitute “significant new information.” The revisions primarily incorporate analysis of a new alternative, with a comparison of the alternative’s impacts to those of the proposed project. As such, these revisions do not result in a new significant environmental impact from the project or from a new mitigation measure, as the project analysis and mitigation measures have not changed [Section 15088.5(1)]. Similarly, the additional air quality and greenhouse gas modeling conducted in support of this

Augmentation to the Final SEIR provide additional information that is supportive of the conclusions in the original alternatives analysis. As described in Section 2, *Additional Amendments to the Draft SEIR*, this additional quantitative modeling does not result in a new significant environmental impact or new mitigation measures [Section 15088.5(1)]. For the same reasons, the revisions do not constitute a substantial increase in the severity of an environmental impact [Section 15088.5(2)]. Although a new alternative has been introduced, it is substantially similar to an existing alternative (Alternative 3a). In addition, the project's proponent has not declined to adopt an alternative that would clearly lessen the environmental impacts of the proposed project. As such, Section 15088.5(3) does not apply. Lastly, the Draft and Final SEIR were neither inadequate nor conclusory in nature, and meaningful public review and comment have not been precluded. As noted previously, the County received 118 comment letters on the Draft SEIR, including 103 from members of the public. These reviewers had the opportunity to review Section 17.0, *Alternatives*, of the Draft SEIR, which included a 40-lot subdivision (Alternative 3, No Project/Existing Zoning [40-Unit subdivision]; referred to as Alternative 3a in this Augmentation to the Final SEIR). The new Alternative 3b is substantially similar to Alternative 3a, as it would result in an up to 30-lot subdivision on the same site. Therefore, this new alternative is not substantially different such that the public is being deprived of a meaningful opportunity to comment by its addition. The addition of Alternative 3a and associated revisions to the alternatives analysis instead clarifies, amplifies and makes insignificant modifications to the Draft SEIR.

2 Additional Amendments to the Draft SEIR

This chapter presents specific text changes made to the Draft SEIR since its publication and public review. These changes supplement and do not conflict with the Draft SEIR revisions provided in Section 4, *Revisions to the Draft SEIR*, included in the Final SEIR, which is incorporated by reference. Text deletions are shown in ~~striketrough~~, and text additions are shown in underline. Please note that the entirety of Chapter 17.0, *Alternatives*, of the Draft SEIR is provided below for ease of review, while only portions of other sections of the Draft SEIR are provided, where revisions are made. The information contained within this chapter clarifies and expands on information in the Draft SEIR and does not constitute “significant new information” requiring recirculation, as described above.

4.0 Project Description

4.1 Project Objectives

The objectives of the proposed project, provided by the applicant, are:

- ~~▪ To develop a state of the art facility to provide a Continuum of Care Residential Community designed to provide care to seniors over the age of 55 and to persons with diminishing mental capacity due to Alzheimer’s, dementia, or similar causes.~~
- To provide a range of housing and/or care options for seniors over the age of 55; persons with diminishing mental capacity; and persons who do not require 24-hour skilled nursing care but are in need of a range of personal assistance with the activities of daily living such as dressing, bathing, grooming, and medication management.
- ~~▪ To provide a range of accommodations which will allow persons who only need some help to maintain a modicum of an independent lifestyle to move into smaller home-like suites and then transition to other on-site facilities which can provide a greater level of daily personal assistance as needed.~~
- To provide housing such a facility in a geographic location where ~~the need for such a facility~~ it is clearly needed and where adequate public facilities currently exist or can be readily provided.
- To provide housing such a facility in and near an established community so that residents in the facility can feel a sense of connection with local residents ~~and where in turn local residents as they age or their circumstances change can relocate to an assisted living facility without the need to move from their community or far away from their families.~~
- To address the critical need for housing for residents of the community in need of suitable housing options.
- ~~▪ To provide a range of job and volunteer opportunities for persons in the area and in the Las Palmas community.~~
- ~~▪ Be licensed by the State of California as a Residential Care Facility for the Elderly (RCFE).~~

17.0 Alternatives

17.1 CEQA Requirements

CEQA Guidelines section 15126.6(a) requires a description of reasonable alternatives to the proposed project, or to the location of the project, which could feasibly attain most of the basic objectives of the project but would avoid or substantially lessen any of the significant effects of the project. It also requires an evaluation of the comparative merits of the alternatives. An EIR need not consider every conceivable alternative to a project, but must consider a reasonable range of potentially feasible alternatives that will foster informed decision-making and public participation. CEQA Guidelines section 15126.6(b) further requires that the discussion of alternatives focus on those alternatives capable of eliminating any significant adverse environmental impacts or reducing them to a level of insignificance, even if these alternatives would impede to some degree the attainment of the project objectives or would be more costly. CEQA Guidelines section 15126.6(e) stipulates that a no project alternative be evaluated along with its impacts.

CEQA Guidelines section 15126.6(d) requires the EIR to present enough information about each alternative to allow meaningful evaluation, analysis and comparison with the proposed project. If an alternative would cause one or more significant effects in addition to those that would be caused by the project as proposed, the significant effects of the alternative shall be discussed, but in less detail than the significant effects of the project as proposed. CEQA Guidelines section 15126.6(e) requires the identification of an environmentally superior alternative. If the "No Project" alternative is the environmentally superior alternative, then the environmentally superior alternative amongst the remaining alternatives must be identified.

17.2 Alternatives Considered

The following alternatives to the project are considered:

- Alternative 1: No project/no development;
- Alternative 2: No project/minimum use;
- Alternative 3a: No project/existing zoning (40-Lot Subdivision);
- Alternative 3b: Reduced no project/existing zoning (up to a 30-Lot Subdivision); and
- Alternative 4: Reduced project.

Each of these alternatives are is described below, followed by a summary of impacts associated with the proposed project and an analysis of how each alternative may reduce impacts associated with the proposed project. Where possible, impacts associated with each alternative are discussed quantitatively. To more clearly compare impacts associated with air quality and greenhouse gas (GHG) emissions of each alternative, construction and operational emissions associated with each alternative were estimated using the California Emissions Estimator Model (CalEEMod), version 2022.1.1.16. CalEEMod was developed for use throughout the state in estimating construction, operational, and mobile-source emissions. Potential buildout of each project alternative was estimated and assumptions were incorporated into the CalEEMod modeling. CalEEMod modeling outputs are included as Appendix A.

Alternative 1: No Project/No Development

CEQA Guidelines section 15126.6 (e) requires the “no project” alternative be evaluated along with its impacts. The “no project” alternative analysis must discuss the existing conditions, as well as what would be reasonably expected to occur in the foreseeable future if the project were not approved, based on current plans and consistent with available infrastructure and community services.

Alternative Description

The “no project/no development” alternative assumes no development would occur on the project site. The project site would continue to be vacant land, partially used for grazing. Under this alternative, there would be no potential adverse impacts to aesthetics, air quality biological resources, GHG emissions, transportation and traffic, or water supply.

Alternative 2: No Project/Minimum Use

Alternative Description

The “no project/minimum use” alternative assumes the proposed project would not be constructed or operated on the project site. Instead, this alternative considers the construction of the minimum allowable use on the subject property, which would be one single family dwelling and any accessory structures considered incidental to residential use, such as barns and storage buildings.

Aesthetics

The proposed project would impact scenic vistas and the visual character of the site, and would introduce new sources of light and glare to the project site and vicinity. Impacts to scenic vistas, the visual character of the site, and the introduction of new sources of light and glare would be potentially significant impacts, but would be reduced to less-than-significant levels with the application of Mitigation Measures AES-1, AES-2, AES-3, and AES-4.

Alternative 2 would have less aesthetic-related impacts than the proposed project. Although possible to have aesthetic impacts based on the size and location on the project site of any structures related to a single-family residence, any potential impacts would be less than the proposed project. However, this form of development may still be within the public viewshed from scenic vista points, would change the visual character of the site from undeveloped to developed, and would also introduce new sources of light and glare to the project site and vicinity. Similar mitigation measures to reduce impacts to a less-than-significant level as for the proposed project would likely be applicable to Alternative 2, depending on proposed site design. However, as there would be no discretionary approval for the project, having enforceable mitigation measures applied to the site would be unlikely.

Air Quality

The proposed project would have air quality-related impacts related to emissions during construction of the proposed project on the site. These impacts would be potentially significant impacts, but would be reduced to less-than-significant levels with the application of Mitigation Measures AQ-1, AQ-2, AQ-3, and AQ-4.

Alternative 2 would have less air quality-related impacts than the proposed project. Construction activities on the project site for one single family residence and associated structures would have

construction related emissions; ~~h~~However, construction emissions would be substantially lower than the emissions of the proposed project, which would involve greater and more intense emissions associated with the construction of the assisted living facility, memory care facility, and 13 Casitas residential units. The estimated construction emissions associated with Alternative 2 are shown below in Table 17-1 and are compared to maximum emissions thresholds established by the Monterey Bay Air Resources District (MBARD). For informational purposes, construction emissions of the proposed project were estimated using CalEEMod version 2022.1.1.16, consistent with the modeling of Alternative 2 emissions. These estimates are not intended to supersede the air quality modeling provided in Chapter 6.0, *Air Quality*, of the Draft SEIR, which used CalEEMod version 2016.3.1. Rather, they are intended to standardize the emissions modeling outputs for equitable comparison within this alternatives analysis.

Table 17-1 Estimated Construction Emissions of Alternative 2

	Maximum Daily Emissions (lbs/day)						Annual Emissions (MT/year)
	ROG	NO _x	PM ₁₀	CO	SO ₂	PM _{2.5}	CO _{2e}
<u>Proposed Project Maximum Construction Emissions¹</u>	<u>196</u>	<u>58</u>	<u>26</u>	<u>41</u>	<u><1</u>	<u>13</u>	<u>617</u>
<u>Alternative 2: Construction Year 2024</u>	<u>4</u>	<u>52</u>	<u>25</u>	<u>39</u>	<u><1</u>	<u>12</u>	<u>470</u>
<u>Alternative 2: Construction Year 2025</u>	<u>3</u>	<u>10</u>	<u><1</u>	<u>13</u>	<u><0.1</u>	<u><1</u>	<u>100</u>
MBARD Thresholds	137	137	82	N/A	152	N/A	N/A

lbs/day = pounds per day; MT/year = metric tons per year; ROG = reactive organic compounds; NO_x = oxides of nitrogen; CO = carbon monoxide; SO₂ = sulfur dioxide; PM₁₀ = particulate matter with a diameter of 10 microns or less; PM_{2.5} = particulate matter with a diameter of 2.5 microns or less; CO_{2e} = carbon dioxide equivalents; N/A = not applicable; MBARD = Monterey Bay Air Resources District

Notes: Emissions estimates are rounded to the nearest whole number. Emissions modeling was completed using CalEEMod. See Appendix A for modeling results.

¹ Proposed project air quality emissions were modeled here using CalEEMod version 2022.1.1.16 for informational purposes. The air quality emissions in Chapter 6.0, *Air Quality*, of the Draft SEIR used an older version of the model, which is no longer recommended for use.

Source: MBARD 2008

As shown above in Table 17-1, emissions associated with Alternative 2 would not exceed thresholds established by MBARD, and would be reduced compared to the proposed project. Based based on the reduced scale of construction, construction emissions would not represent significant impacts and no mitigation measures would likely be required to reduce impacts to a less-than-significant level.

In operation, Alternative 2 would result in reduced emissions compared to the proposed project. Table 17-2 shows estimated operational emissions associated with Alternative 2. For informational purposes, operational emissions of the proposed project were estimated using CalEEMod version 2022.1.1.16, consistent with the modeling of Alternative 2 emissions. These estimates are not intended to supersede the air quality modeling provided in Chapter 6.0, *Air Quality*, of the Draft SEIR. Rather, they are intended to standardize the emissions modeling outputs for equitable comparison within this alternatives analysis.

Table 17-2 Estimated Operational Emissions of Alternative 2

	<u>ROG</u>	<u>NO_x</u>	<u>PM₁₀</u>	<u>CO</u>	<u>SO₂</u>	<u>PM_{2.5}</u>	<u>CO_{2e} (MT/year)</u>
<u>Proposed Project Annual Emissions¹ (tpy)</u>	<u>1</u>	<u><1</u>	<u><1</u>	<u>4</u>	<u><0.1</u>	<u><1</u>	<u>1,005</u>
<u>Alternative 2 Annual Emissions (tpy)</u>	<u><0.1</u>	<u><0.1</u>	<u><0.1</u>	<u><0.1</u>	<u><0.1</u>	<u><0.1</u>	<u>19</u>

tpy = tons per year; MT/year = metric tons per year; ROG = reactive organic compounds; NO_x = oxides of nitrogen; CO = carbon monoxide; SO₂ = sulfur dioxide; PM₁₀ = particulate matter with a diameter of 10 microns or less; PM_{2.5} = particulate matter with a diameter of 2.5 microns or less; CO_{2e} = carbon dioxide equivalents

Notes: Emissions estimates are rounded to the nearest whole number. Emissions modeling was completed using CalEEMod. See Appendix A for modeling results.

¹ Proposed project air quality emissions were modeled here using CalEEMod version 2022.1.1.16 for informational purposes. The air quality emissions in Chapter 6.0, *Air Quality*, of the Draft SEIR used an older version of the model, which is no longer recommended for use.

As shown above, Alternative 2 would not generate considerable amounts of air pollutants in operation. Operational air quality emissions would be reduced compared to the proposed project, as the operation of the larger assisted living facilities would generate more emissions than a single-family residence.

The air quality impacts of Alternative 2 would be less than significant and would not require implementation of Mitigation Measures AQ-1, AQ-2, AQ-3, and AQ-4. Impacts would be reduced compared to the proposed project, as the proposed project would require mitigation.

Biological Resources

The proposed project would impact biological resources, including potential loss or disturbance of American badgers, potential loss or disturbance of burrowing owls, potential loss or disturbance of Monterey dusky-footed woodrats, potential loss or disturbance of special-status bats, and potential loss or disturbance of nesting birds. All potential impacts can be reduced to less-than-significant levels with implementation of Mitigation Measures BIO-1, BIO-2, BIO-3, BIO-4, BIO-5, and BIO-6. The proposed project would also have a less-than-significant impact on impeding the movement of common wildlife.

Alternative 2 would have much fewer potential biological impacts than the proposed project. Construction activities on the project site for one single family residence and associated structures would result in minimal impacts—~~significant impacts~~ to biological resources due to the smaller building footprint.

Greenhouse Gas Emissions

The proposed project’s greenhouse gas emissions would be less than significant and no mitigation measures are required. For informational purposes, GHG emissions of the proposed project were estimated using CalEEMod version 2022.1.1.16, consistent with the modeling of Alternative 2 emissions. These estimates are not intended to supersede the GHG modeling provided in Chapter 8.0, *Greenhouse Gas Emissions*, of the Draft SEIR, which used CalEEMod version 2016.3.1. Rather, they are intended to standardize the emissions modeling outputs for equitable comparison within this alternatives analysis. The proposed project would result in a total of 617 metric tons per year (MT/year) of carbon dioxide equivalent (CO_{2e}) during construction and 1,005 MT/year of CO_{2e} during operation (please refer to Table 17-1 and Table 17-2).

As shown in Table 17-1 under *Air Quality*, this alternative would generate approximately 570 MT/year of CO₂e during construction. Additionally, as shown in Table 17-2, Alternative 2 would generate approximately 19 MT/year of CO₂e during operation (Appendix A). Neither the County of Monterey, MBARD, nor any other state or applicable regional agency has adopted a numerical significance threshold for assessing GHG emissions that is applicable to the project. Additionally, emissions associated with Alternative 2 would be relatively negligible, as the construction of a single-family residence would not generate a substantial amount of GHG emissions. Alternative 2 would result in fewer greenhouse gas emissions than the proposed project, and impacts, which would be less than significant and no mitigation measures would be required.

Transportation and Traffic

As a combined assisted living facility (100 beds) and detached assisted living units ~~units~~ (26 units; 42 beds), based on ITE trip generation rates for each category, the proposed project would ~~generation~~ generate approximately 363 daily trips (266 for assisted living facility and 96 for the detached assisted living units). The proposed project would result in less-than-significant impacts to area intersections and roadways segments of River Road. However, the proposed project would result in a significant and unavoidable impact of adding additional traffic to SR 68.

Based on trip generation rates for single family homes in the Las Palmas development, one single family residence on the project site would generate approximately 7.1 daily trips.

Therefore, Alternative 2 would result in a decreased amount of daily trips to and from the project site and can be expected to have less impacts than the proposed project. However, as even one single family residence could result in additional traffic on SR 68 during the AM and/or PM peak hours, Alternative 2 would also result in a significant and unavoidable impact.

Water Supply

The proposed project would have an estimated water demand of 11.376 AFY. ~~Applying the water demand assigned to the casita units of the proposed project (2.876 AFY for 26 units) for the conceptual build-out of one single family residential unit on the project site would be significantly less.~~ The single-family residence that would be constructed under Alternative 2 would be expected to have a water demand of approximately 0.12 AFY (Monterey Peninsula Water Management District 2022),³ which is substantially less than the water demand of the proposed project. Therefore, while the proposed project would result in a less-than-significant impact to water supply, Alternative 2 would result in a lower water demand.

Alternative 3a: No Project/Existing Zoning (40-Lot Subdivision)

Alternative Description

The “no project/existing zoning (40-lot subdivision)” alternative assumes the proposed project would not be constructed or operated on the project site. However, considering that the project site is designated for medium density residential development, it is reasonable to assume that up to 40 dwelling units could be approved and constructed on the project site. Although, it is worth noting that other use categories could also be considered for this alternative. Based on existing zoning for the project site, the following uses could be established on the project site:

³ Rates based on the October 2018 to September 2019 actual residential water usage in Monterey County (510,364,680 gallons per 9,399 residential units), converted to acre-feet.

River View at Las Palmas Assisted Living Senior Facility Project

- Public and quasi-public uses including churches, cemeteries, parks, playgrounds, schools, public safety facility, public utility facilities;
- Mobile home park;
- ~~Agricultural~~ Employee housing;
- Christmas tree cutting and removal and other uses of similar agricultural nature;
- Other uses of a similar nature, density and intensity;
- Transitional Housing; or
- Supportive Housing.

Supportive housing is defined by the Monterey County Code as housing with no limit on length of stay that is occupied by a target population“ ("Target population" means persons with low income having one or more disabilities, including mental illness, HIV or AIDS, substance abuse, or other chronic health conditions, or individuals eligible for services provided under the Lanterman Developmental Disabilities Services Act (California Welfare and Institutions Code, section 4500 et seq.) and may include, among other populations, adults, emancipated youth, families, families with children, elderly persons, young adults aging out of the foster care system, individuals exiting from institutional settings, veterans, and homeless people (MCC 21.06.1278) and is linked to onsite or offsite services that assist the supportive housing resident in retaining the housing, improving their health status, and maximizing their ability to live and, when possible, work in the community. Transitional housing and transitional housing development is considered as buildings configured as rental housing developments, but operated under program requirements that call for the termination of assistance and recirculation of the assisted unit to another eligible program recipient at some predetermined future point in time of no less than six months. The county's zoning code describes each use as being contained within allowed housing units of the zoning district (Monterey County 2017).

Therefore, for purposes of this analysis, Alternative 3a considers that the 40 single-family residential units on the site could also be considered as 40 supportive housing units, or 40 transitional housing units. Each unit could have multiple bedrooms and house a number of persons. For purposes of this alternatives analysis, 40 units of single-family, supportive housing, or transitional units are considered to be roughly equivalent.

Aesthetics

The proposed project would impact scenic vistas and the visual character of the site, and would introduce new sources of light and glare to the project site and vicinity. Impacts to scenic vistas and the introduction of new sources of light and glare would be potentially significant impacts, but would be reduced to less-than-significant levels with the application of Mitigation Measures AES-1, AES-2, AES-3, and AES-4.

Alternative 3a would have similar aesthetic-related impacts as the proposed project, as development on the site of up to 40 residential units would be expected to occur. This form of development would still be within the public viewshed from scenic vista points, would change the visual character of the site from undeveloped to developed, and would also introduce new sources of light and glare to the project site and vicinity. Mitigation measures applicable to the proposed project would also apply to Alternative 3a.

Air Quality

The proposed project would have air quality-related impacts related to emissions during construction of the proposed project on the site. These impacts would be potentially significant impacts, but would be reduced to less-than-significant levels with the application of Mitigation Measures AQ-1, AQ-2, AQ-3, and AQ-4.

Alternative 3a would have similar air quality-related impacts as the proposed project, as development on the site of up to 40 residential units would be expected to occur. The estimated construction emissions associated with Alternative 3a are shown below in Table 17-3 and are compared to maximum emissions thresholds established by MBARD. For informational purposes, construction emissions of the proposed project were estimated using CalEEMod version 2022.1.1.16, consistent with the modeling of Alternative 3a emissions. These estimates are not intended to supersede the air quality modeling provided in Chapter 6.0, *Air Quality*, of the Draft SEIR. Rather, they are intended to standardize the emissions modeling outputs for equitable comparison within this alternatives analysis.

Table 17-3 Estimated Construction Emissions of Alternative 3a

	Maximum Daily Emissions (lbs/day)						Annual Emissions (MT/year)
	ROG	NO _x	PM ₁₀	CO	SO ₂	PM _{2.5}	CO _{2e}
Proposed Project Maximum Construction Emissions ¹	196	58	26	41	<1	13	617
Alternative 3a: Construction Year 2024	4	52	25	39	<1	13	490
Alternative 3a: Construction Year 2025	104	11	<1	14	<0.1	<1	107
MBARD Thresholds	137	137	82	N/A	152	N/A	N/A

lbs/day = pounds per day; MT/year = metric tons per year; ROG = reactive organic compounds; NO_x = oxides of nitrogen; CO = carbon monoxide; SO₂ = sulfur dioxide; PM₁₀ = particulate matter with a diameter of 10 microns or less; PM_{2.5} = particulate matter with a diameter of 2.5 microns or less; CO_{2e} = carbon dioxide equivalents; N/A = not applicable; MBARD = Monterey Bay Air Resources District

Notes: Emissions estimates are rounded to the nearest whole number. Emissions modeling was completed using CalEEMod. See Appendix A for modeling results.

¹ Proposed project air quality emissions were modeled here using CalEEMod version 2022.1.1.16 for informational purposes. The air quality emissions in Chapter 6.0, *Air Quality*, of the Draft SEIR used an older version of the model, which is no longer recommended for use.

Source: MBARD 2008

As shown in Table 17-3, construction emissions associated with Alternative 3a would not exceed MBARD thresholds, and would be reduced compared to the proposed project. However, grading and construction of the 40 housing units would occur directly adjacent to the existing residences west of the project site, and generation of air emissions in proximity to these receivers could be significant. Construction activities on the project site for up to this number of residences would have construction related emissions which would be potentially significant. Mitigation measures applicable to the proposed project would also apply to Alternative 3a. Impacts would be reduced compared to the proposed project and would be less than significant with mitigation.

In operation, Alternative 3a would result in reduced emissions compared to the proposed project. Table 17-4 shows estimated operational emissions associated with Alternative 3a. For informational purposes, operational emissions of the proposed project were estimated using CalEEMod version

2022.1.1.16, consistent with the modeling of Alternative 3a emissions. These estimates are not intended to supersede the air quality modeling provided in Chapter 6.0, Air Quality, of the Draft SEIR. Rather, they are intended to standardize the emissions modeling outputs for equitable comparison within this alternatives analysis.

Table 17-4 Estimated Operational Emissions of Alternative 3a

	<u>ROG</u>	<u>NO_x</u>	<u>PM₁₀</u>	<u>CO</u>	<u>SO₂</u>	<u>PM_{2.5}</u>	<u>CO₂e (MT/year)</u>
<u>Proposed Project Annual Emissions¹ (tpy)</u>	<u>1</u>	<u><1</u>	<u><1</u>	<u>4</u>	<u><0.1</u>	<u><1</u>	<u>1,005</u>
<u>Alternative 3a Annual Emissions (tpy)</u>	<u><1</u>	<u><1</u>	<u><1</u>	<u>3</u>	<u><0.1</u>	<u><1</u>	<u>759</u>

tpy = tons per year; MT/year = metric tons per year; ROG = reactive organic compounds; NO_x = oxides of nitrogen; CO = carbon monoxide; SO₂ = sulfur dioxide; PM₁₀ = particulate matter with a diameter of 10 microns or less; PM_{2.5} = particulate matter with a diameter of 2.5 microns or less; CO₂e = carbon dioxide equivalents
Notes: Emissions estimates are rounded to the nearest whole number. Emissions modeling was completed using CalEEMod. See Appendix A for modeling results.
¹ Proposed project air quality emissions were modeled here using CalEEMod version 2022.1.1.16 for informational purposes. The air quality emissions in Chapter 6.0, Air Quality, of the Draft SEIR used an older version of the model, which is no longer recommended for use.

As shown above, Alternative 3a would not generate considerable amounts of air pollutants in operation, and would result in reduced air quality emissions as compared to the proposed project.

Air quality impacts of Alternative 3a would be reduced compared to the proposed project and would be less than significant with Mitigation Measures AQ-1, AQ-2, AQ-3, and AQ-4, similar to the proposed project.

Biological Resources

The proposed project would impact biological resources, including potential loss or disturbance of American badgers, potential loss or disturbance of burrowing owls, potential loss or disturbance of Monterey dusky-footed woodrats, potential loss or disturbance of special-status bats, and potential loss or disturbance of nesting birds. All potential impacts can be reduced to less-than-significant levels with implementation of Mitigation Measures BIO-1, BIO-2, BIO-3, BIO-4, BIO-5, and BIO-6. The proposed project would also have a less-than-significant impact on impeding the movement of common wildlife.

Alternative 3a would have similar biological impacts as the proposed project, as development on the site of up to 40 residential units would be expected to occur. Mitigation measures applicable to the proposed project would also apply to Alternative 3a.

Greenhouse Gas Emissions

The proposed project’s greenhouse gas emissions would be less than significant and no mitigation measures are required. For informational purposes, GHG emissions of the proposed project were estimated using CalEEMod version 2022.1.1.16, consistent with the modeling of Alternative 3a emissions. These estimates are not intended to supersede the GHG modeling provided in Chapter 8.0, Greenhouse Gas Emissions, of the Draft SEIR. Rather, they are intended to standardize the emissions modeling outputs for equitable comparison within this alternatives analysis. The proposed project would result in a total of 617 MT/year of CO₂e during construction and 1,005 MT/year of CO₂e during operation (please refer to Table 17-3 and Table 17-4).

As shown in Table 17-3 under Air Quality for Alternative 3a, this alternative would generate approximately 597 MT/year of CO₂e during construction. Additionally, Alternative 3a would generate approximately 759 MT/year of CO₂e during operation (Appendix A). Neither the County of Monterey, MBARD, nor any other state or applicable regional agency has adopted a numerical significance threshold for assessing GHG emissions that is applicable to the project. GHG emissions associated with Alternative 3a would be reduced as compared to the proposed project, and impacts would remain less than significant, similar to the proposed project. ~~Alternative 3a would also result in greenhouse gas emissions which would be less than significant and no~~ No mitigation measures would be required.

Transportation and Traffic

As a combined assisted living facility (100 beds) and detached assisted living units (26 units; 42 beds), based on ITE trip generation rates for each category, the proposed project would ~~generation~~ generate approximately 362 daily trips (266 for assisted living facility and 96 for senior adult housing units). The proposed project would result in less-than-significant impacts to area intersections and roadway segments of River Road. However, the proposed project would result in a significant and unavoidable impact of adding additional traffic to SR 68.

Based on trip generation rates for single family homes in the Las Palmas development, 40 single family residences on the project site would generate approximately 284 daily trips.

Therefore, Alternative 3a would result in fewer an increased amount of daily trips to and from the project site and can be expected to have lesser greater impacts than the proposed project. However, Furthermore, Alternative 3a would still also result in a significant and unavoidable impact to SR 68. Mitigation measures applicable to the proposed project would also apply to Alternative 3a.

Water Supply

The proposed project would have an estimated water demand of 11.376 AFY. The 40 housing units that would be constructed under Alternative 3a would be expected to have a water demand of approximately 6.7 AFY (Monterey Peninsula Water Management District 2022),⁴ which is less than the water demand of the proposed project. Therefore, Alternative 3a would result in a less-than-significant impact to water supply, and impacts would be lesser than the proposed project. Applying the water demand assigned to the casita units of the proposed project (2.876 AFY for 26 units) for the conceptual build-out of up to 40 single family residential units on the project site would likely be less than 5.00 AFY. Therefore, while the proposed project would result in a less than significant impact to water supply, Alternative 3a would result in a lower water demand.

Alternative 3b: Reduced No Project/Existing Zoning (Up to a 30-Lot Subdivision)

Alternative Description

The “30-Lot Subdivision” alternative would include subdivision of the project site into no more than 30 lots, which would be developed with single-family residences. Under this alternative, the project site would be subdivided into 30 residential lots and an open space parcel and developed with 30 single-family residences, four of which would be affordable housing units. If the four affordable

⁴ Rates based on the October 2018 to September 2019 actual residential water usage in Monterey County (510,364,680 gallons per 9,399 residential units), converted to acre-feet.

units are not developed on site, the project site would be subdivided into 26 lots and an open space parcel and developed with 26 single-family residences, and the project applicant would pay an in-lieu affordable housing fee to the County. To provide a conservative analysis, a 30-lot subdivision is evaluated in this analysis.

Lot sizes would vary in area and would be between 4,249 square feet and 11,785 square feet; the median lot size would be 5,796 square feet. Lots are clustered pursuant to Section 21.12.060.A of the County Municipal code. The subdivided parcels would encompass approximately 160,000 square feet of the project site. However, due to site coverage and setback limits, less than 160,000 square feet of the project site would be developed with residences under this alternative (the remainder would be left as open space). The total area of Alternative 3b would be 30,000 square feet less than that of the proposed project and would encompass approximately 23.2 percent of the project site, or 4.4 percent less than the proposed project.

Similar to the proposed project, the site would be accessible via Woodridge Court and a new residential roadway would be constructed within the project site to provide access to each lot. Proposed residences would be a maximum of 20 feet in height measured from average natural grade, which is less than the maximum allowable building height of 30 feet from average natural grade. Alternative 3b would require removal of approximately 70 eucalyptus trees, which would be reduced compared to the 80 trees that would be removed under the proposed project. Some of the trees that would remain under Alternative 3b are within the Critical Viewshed as defined in the Toro Area Plan. Although they are not a protected tree species within Monterey County, the trees aid in shielding the potential development from the viewshed of SR 68, River Road, and Las Palmas #1. Alternative 3b would also include 13 off-street guest parking spaces (not associated with a specific residence) along the proposed residential roadway. Water, sewer, electricity, and natural gas providers would be the same as under the proposed project.

Aesthetics

The proposed project would impact scenic vistas and the visual character of the site, and would introduce new sources of light and glare to the project site and vicinity. Impacts to scenic vistas and the introduction of new sources of light and glare would be potentially significant impacts of the proposed project, but would be reduced to less-than-significant levels with the application of Mitigation Measures AES-1, AES-2, AES-3, and AES-4.

Development facilitated by Alternative 3b would be reduced compared to the proposed project. The total area of the residential subdivision under this alternative would encompass approximately 160,000 square feet, 30,000 square feet less than the proposed project. Additionally, the scale and massing of up to 30 single-family residences (up to 20 feet in height) would be substantially reduced compared to the assisted care living facility, memory care living facility (up to 30 feet in height, located within a Critical Viewshed of the Toro Area Plan), and 13 Casitas residential buildings included in the proposed project. Alternative 3b would introduce less light and glare to the project site compared to the proposed project, and the removal of 10 fewer on-site trees (70 trees under Alternative 3b as compared to 80 trees under the proposed project) would result in more similar views of the site from the viewshed of SR 68, River Road, and Las Palmas #1 as under existing conditions. Additionally, on-site development under Alternative 3b would be similar to surrounding residential development. The single-family residences would be more visually consistent with the existing residences in the project vicinity, and would not conflict with the Las Palmas Ranch Specific Plan Design Guidelines.

Impacts under Alternative 3b would be reduced compared to the proposed project as development would be substantially reduced in scale. Mitigation Measures AES-1, AES-2, AES-3, and AES-4 would also apply to Alternative 3b to reduce impacts associated with views from SR 68, exterior lighting, and visual consistency with the existing landscape. Aesthetic impacts of Alternative 3b would be reduced compared to the proposed project and would be less than significant with mitigation.

Air Quality

The proposed project would have air quality-related impacts related to emissions during construction of the proposed project on the site. These impacts would be potentially significant, but would be reduced to less-than-significant levels with the application of Mitigation Measures AQ-1, AQ-2, AQ-3, and AQ-4.

Alternative 3b would involve construction and grading activities similar to the proposed project. However, due to the reduced scale and size of Alternative 3b, less construction and grading would be required, which would reduce the severity of potentially significant impacts. Additionally, the proposed lots would be located in an area of the project site with gentler grades, compared to some proposed project components that would be located on steeper grades, and less grading would be required as a result. The estimated construction emissions associated with Alternative 3b are shown below in Table 17-5 and are compared to maximum emissions thresholds established by MBARD. For informational purposes, construction emissions of the proposed project were estimated using CalEEMod version 2022.1.1.16, consistent with the modeling of Alternative 3b emissions. These estimates are not intended to supersede the air quality modeling provided in Chapter 6.0, *Air Quality*, of the Draft SEIR. Rather, they are intended to standardize the emissions modeling outputs for equitable comparison within this alternatives analysis.

Table 17-5 Estimated Construction Emissions of Alternative 3b

	Maximum Daily Emissions (lbs/day)						Annual Emissions (MT/year)
	ROG	NO _x	PM ₁₀	CO	SO ₂	PM _{2.5}	CO _{2e}
Proposed Project Maximum Construction Emissions ¹	196	58	26	41	<1	13	617
Alternative 3b: Construction Year 2024	4	52	25	39	<1	13	466
Alternative 3b: Construction Year 2025	78	11	<1	14	<0.1	<1	94
MBARD Thresholds	137	137	82	N/A	152	N/A	N/A

lbs/day = pounds per day; MT/year = metric tons per year; ROG = reactive organic compounds; NO_x = oxides of nitrogen; CO = carbon monoxide; SO₂ = sulfur dioxide; PM₁₀ = particulate matter with a diameter of 10 microns or less; PM_{2.5} = particulate matter with a diameter of 2.5 microns or less; CO_{2e} = carbon dioxide equivalents; N/A = not applicable; MBARD = Monterey Bay Air Resources District

Notes: Emissions estimates are rounded to the nearest whole number. Emissions modeling was completed using CalEEMod. See Appendix A for modeling results.

¹ Proposed project air quality emissions were modeled here using CalEEMod version 2022.1.1.16 for informational purposes. The air quality emissions in Chapter 6.0, *Air Quality*, of the Draft SEIR used an older version of the model, which is no longer recommended for use.

Source: MBARD 2008

As shown in Table 17-5, construction emissions associated with Alternative 3b would not exceed MBARD thresholds, and would be reduced compared to the proposed project. Similar to the

proposed project, Alternative 3b would generate dust and construction emissions and Mitigation Measures AQ-1 through AQ-4 would be required; however, construction emissions would be reduced compared to the proposed project and would be less than significant with mitigation. Additionally, due to the proposed location of residences under Alternative 3b, grading and other construction activities would be located farther from nearby off-site residences than under the proposed project.

In operation, Alternative 3b would result in reduced emissions compared to the proposed project. Table 17-6 shows estimated operational emissions associated with Alternative 3b. For informational purposes, operational emissions of the proposed project were estimated using CalEEMod version 2022.1.1.16, consistent with the modeling of Alternative 3b emissions. These estimates are not intended to supersede the air quality modeling provided in Chapter 6.0, *Air Quality*, of the Draft SEIR. Rather, they are intended to standardize the emissions modeling outputs for equitable comparison within this alternatives analysis.

Table 17-6 Estimated Operational Emissions of Alternative 3b

	<u>ROG</u>	<u>NO_x</u>	<u>PM₁₀</u>	<u>CO</u>	<u>SO₂</u>	<u>PM_{2.5}</u>	<u>CO₂e (MT/year)</u>
<u>Proposed Project Annual Emissions¹ (tpy)</u>	<u>1</u>	<u><1</u>	<u><1</u>	<u>4</u>	<u><0.1</u>	<u><1</u>	<u>1,005</u>
<u>Alternative 3b Annual Emissions (tpy)</u>	<u><1</u>	<u><1</u>	<u><0.1</u>	<u>3</u>	<u><0.1</u>	<u><1</u>	<u>569</u>

tpy = tons per year; MT/year = metric tons per year; ROG = reactive organic compounds; NO_x = oxides of nitrogen; CO = carbon monoxide; SO₂ = sulfur dioxide; PM₁₀ = particulate matter with a diameter of 10 microns or less; PM_{2.5} = particulate matter with a diameter of 2.5 microns or less; CO₂e = carbon dioxide equivalents

Notes: Emissions estimates are rounded to the nearest whole number. Emissions modeling was completed using CalEEMod. See Appendix A for modeling results.

¹ Proposed project air quality emissions were modeled here using CalEEMod version 2022.1.1.16 for informational purposes. The air quality emissions in Chapter 6.0, *Air Quality*, of the Draft SEIR used an older version of the model, which is no longer recommended for use.

As shown above, Alternative 3b would not generate considerable amounts of air pollutants in operation. Operational air emissions would be reduced compared to the proposed project, as the operation of the larger assisted living facilities would generate more emissions than up to 30 residences.

Air quality impacts of Alternative 3b would be reduced compared to the proposed project and would be less than significant with Mitigation Measures AQ-1, AQ-2, AQ-3, and AQ-4, similar to the proposed project.

Biological Resources

The proposed project would impact biological resources, including potential loss or disturbance of American badgers, potential loss or disturbance of burrowing owls, potential loss or disturbance of Monterey dusky-footed woodrats, potential loss or disturbance of special-status bats, and potential loss or disturbance of nesting birds. All potential impacts can be reduced to less-than-significant levels with implementation of Mitigation Measures BIO-1, BIO-2, BIO-3, BIO-4, BIO-5, and BIO-6. The proposed project would also have a less-than-significant impact on impeding the movement of common wildlife.

Alternative 3b would disturb less of the project site than the proposed project, and would involve development of approximately 30,000 fewer square feet than the proposed project. As described in

the Alternative Description for Alternative 3b, this alternative would develop approximately 4.4 percent less of the project site compared to the proposed project. Ten (10) fewer trees would be removed, which would reduce potential impacts to nesting birds and bats, and less undeveloped land would be disturbed, which would reduce impacts to American badgers, burrowing owls, and Monterey dusky-footed woodrats.

Because Alternative 3b would involve construction, ground disturbance, and tree removal, Mitigation Measures BIO-1, BIO-2, BIO-3, BIO-4, BIO-5, and BIO-6 would still apply. However, impacts would be reduced compared to the proposed project and would be less than significant with mitigation.

Greenhouse Gas Emissions

The proposed project's GHG emissions would be less than significant and no mitigation measures are required. For informational purposes, GHG emissions of the proposed project were estimated using CalEEMod version 2022.1.1.16, consistent with the modeling of Alternative 3b emissions. These estimates are not intended to supersede the GHG modeling provided in Chapter 8.0, Greenhouse Gas Emissions, of the Draft SEIR. Rather, they are intended to standardize the emissions modeling outputs for equitable comparison within this alternatives analysis. The proposed project would result in a total of 617 MT/year of CO₂e during construction and 1,005 MT/year of CO₂e during operation (please refer to Table 17-5 and Table 17-6).

As shown in Table 17-5 and Table 17-6 under Air Quality for Alternative 3b, the project would generate approximately 560 MT/year of CO₂e during construction and 569 MT/year of CO₂e during operation. Neither the County of Monterey, MBARD, nor any other state or applicable regional agency has adopted a numerical significance threshold for assessing GHG emissions that is applicable to the project. Emissions associated with Alternative 3b would be less than those of the proposed project, and impacts would be less than significant. Therefore, greenhouse gas emissions associated with Alternative 3b would be reduced compared to the proposed project and impacts would be less than significant.

Transportation and Traffic

As a combined assisted living facility (100 beds) and detached assisted living units (26 units; 42 beds), based on ITE trip generation rates for each category, the proposed project would generate approximately 362 daily trips (266 for assisted living facility and 96 for senior adult housing units). The proposed project would result in less-than-significant impacts to area intersections and roadways segments of River Road. However, the proposed project would result in a significant and unavoidable impact of adding additional traffic to SR 68.

A Traffic Impact Analysis was prepared for Alternative 3b by Keith Higgins, Traffic Engineer, in December 2022. The Traffic Impact Analysis was revised with a memo in March 2022 to estimate traffic impacts associated with up to 30 residences. The Traffic Impact Analysis and memo are included as Appendix B.

Alternative 3b would be expected to generate trips at a similar rate to existing residences near the project site. Up to 30 lots facilitated by Alternative 3b would be expected to generate approximately 264 daily trips, with 20 AM peak hour trips and 26 PM peak hour trips. This is a reduction of 98 trips per day, or 27 percent fewer trips compared to the proposed project. The addition of these trips to area roadways would be expected to result in imperceptible increases in delay on area roadways,

and would not result in a change in level of service from existing conditions. Refer to Appendix B for additional detail.

The proposed project was determined to result in a significant and unavoidable impact associated with adding additional traffic to SR 68. Approximately 14 percent of trips associated with Alternative 3b would be added to the two-lane segment of SR 68, which would represent one peak hour trip on average (Appendix B), the same as under the proposed project. Therefore, as SR 68 continues to operate at LOS F during peak hours, Alternative 3b would also result in significant and unavoidable impacts to the level of service of SR 68, and impacts would be similar to the proposed project. No feasible mitigation measures are available to reduce this impact.

Water Supply

The proposed project would have an estimated water demand of 11.376 AFY. The maximum of 30 residences that would be constructed under Alternative 3b would be expected to have a water demand of approximately 5.0 AFY (Monterey Peninsula Water Management District 2022),⁵ which is less than the water demand of the proposed project. Therefore, Alternative 3b would result in a less-than-significant impact to water supply, and impacts would be lesser than the proposed project.

Alternative 4: Reduced Project

Alternative Description

The “reduced project” alternative includes a reduced development footprint. For conceptual purposes, Alternative 4 eliminates the casitas from the proposed project. This would result in the loss of 26 living units with 42 beds, representing 30 percent of the total beds of the proposed project, and would result in a proportionate reduction in environmental impacts. Therefore, under this reduced project scenario, development on the project site would include the assisted living facility and memory care living facility, and other associated site improvements.

Aesthetics

The proposed project would impact scenic vistas and the visual character of the site, and would introduce new sources of light and glare to the project site and vicinity. Impacts to scenic vistas and the introduction of new sources of light and glare would be potentially significant impacts, but would be reduced to less-than-significant levels with the application of Mitigation Measures AES-1, AES-2, AES-3, and AES-4.

Alternative 4 would have similar, albeit slightly less, aesthetic-related impacts as the proposed project, as development on the site of the assisted living facility and memory care facility would still be within the public viewshed from scenic vista points and would also introduce new sources of light and glare to the project site and vicinity. Mitigation measures applicable to the proposed project would also apply to Alternative 4.

Air Quality

The proposed project would have air quality-related impacts related to emissions during construction of the proposed project on the site. These impacts would be potentially significant

⁵ Rates based on the October 2018 to September 2019 actual residential water usage in Monterey County (510,364,680 gallons per 9,399 residential units), converted to acre-feet.

impacts, but would be reduced to less-than-significant levels with the application of Mitigation Measures AQ-1, AQ-2, AQ-3, and AQ-4.

Alternative 4 would have similar air quality-related impacts as the proposed project, but to a lesser extent based on a reduced amount of construction activities that would occur on the site. The estimated construction emissions associated with Alternative 4 are shown below in Table 17-7 and are compared to maximum emissions thresholds established by MBARD. For informational purposes, construction emissions of the proposed project were estimated using CalEEMod version 2022.1.1.16, consistent with the modeling of Alternative 4 emissions. These estimates are not intended to supersede the air quality modeling provided in Chapter 6.0, Air Quality, of the Draft SEIR. Rather, they are intended to standardize the emissions modeling outputs for equitable comparison within this alternatives analysis.

Table 17-7 Estimated Construction Emissions of Alternative 4

	Maximum Daily Emissions (lbs/day)						Annual Emissions (MT/year)
	ROG	NO _x	PM ₁₀	CO	SO ₂	PM _{2.5}	CO _{2e}
Proposed Project Maximum Construction Emissions ¹	196	58	26	41	<1	13	617
Alternative 4: Construction Year 2024	4	52	25	39	<1	13	543
Alternative 4: Construction Year 2025	65	11	1	16	<0.1	<1	126
MBARD Thresholds	137	137	82	N/A	152	N/A	N/A

lbs/day = pounds per day; MT/year = metric tons per year; ROG = reactive organic compounds; NO_x = oxides of nitrogen; CO = carbon monoxide; SO₂ = sulfur dioxide; PM₁₀ = particulate matter with a diameter of 10 microns or less; PM_{2.5} = particulate matter with a diameter of 2.5 microns or less; CO_{2e} = carbon dioxide equivalents; N/A = not applicable; MBARD = Monterey Bay Air Resources District

Notes: Emissions estimates are rounded to the nearest whole number. Emissions modeling was completed using CalEEMod. See Appendix A for modeling results.

Source: MBARD 2008

As shown above in Table 17-7, emissions associated with Alternative 4 would not exceed thresholds established by MBARD, and would be reduced compared to the proposed project. However, similar to the proposed project, grading and construction of the reduced senior assisted living facilities would occur directly adjacent to the existing residences west of the project site, and generation of air emissions in proximity to these receivers could be significant. Mitigation measures applicable to the proposed project would also apply to Alternative 4.

In operation, Alternative 4 would result in reduced emissions compared to the proposed project. Table 17-8 shows estimated operational emissions associated with Alternative 4. For informational purposes, operational emissions of the proposed project were estimated using CalEEMod version 2022.1.1.16, consistent with the modeling of Alternative 4 emissions. These estimates are not intended to supersede the air quality modeling provided in Chapter 6.0, Air Quality, of the Draft SEIR. Rather, they are intended to standardize the emissions modeling outputs for equitable comparison within this alternatives analysis.

Table 17-8 Estimated Operational Emissions of Alternative 4

ROG	NO _x	PM ₁₀	CO	SO ₂	PM _{2.5}	CO _{2e}
-----	-----------------	------------------	----	-----------------	-------------------	------------------

County of Monterey
River View at Las Palmas Assisted Living Senior Facility Project

Proposed Project Annual Emissions ¹ (tpy)	<u>1</u>	<u><1</u>	<u><1</u>	<u>4</u>	<u><0.1</u>	<u><1</u>	<u>1,005</u>
Alternative 4 Annual Emissions (MT/year)	<u><1</u>	<u><1</u>	<u><1</u>	<u>3</u>	<u><0.1</u>	<u><1</u>	<u>685</u>

lbs/day = pounds per day; MT/year = metric tons per year; ROG = reactive organic compounds; NO_x = oxides of nitrogen; CO = carbon monoxide; SO₂ = sulfur dioxide; PM₁₀ = particulate matter with a diameter of 10 microns or less; PM_{2.5} = particulate matter with a diameter of 2.5 microns or less; CO_{2e} = carbon dioxide equivalents

Notes: Emissions estimates are rounded to the nearest whole number. Emissions modeling was completed using CalEEMod. See Appendix A for modeling results.

¹ Proposed project air quality emissions were modeled here using CalEEMod version 2022.1.1.16 for informational purposes. The air quality emissions in Chapter 6.0, *Air Quality*, of the Draft SEIR used an older version of the model, which is no longer recommended for use.

As shown above, Alternative 4 would not generate considerable amounts of air pollutants in operation. Operational air emissions would be reduced as compared to the proposed project.

Air quality impacts of Alternative 4 would be reduced as compared to the proposed project and would be less than significant with Mitigation Measures AQ-1, AQ-2, AQ-3, and AQ-4, similar to the proposed project.

Biological Resources

The proposed project would impact biological resources, including potential loss or disturbance of American badgers, potential loss or disturbance of burrowing owls, potential loss or disturbance of Monterey dusky-footed woodrats, potential loss or disturbance of special-status bats, and potential loss or disturbance of nesting birds. All potential impacts can be reduced to less-than-significant levels with implementation of Mitigation Measures BIO-1, BIO-2, BIO-3, BIO-4, BIO-5, and BIO-6. The proposed project would also have a less-than-significant impact on impeding the moment of common wildlife.

Alternative 4 would have similar impacts to biological resources as the proposed project, but to a lesser extent based on a reduced amount of development which would occur on the site. Mitigation measures applicable to the proposed project would also apply to Alternative 4.

Greenhouse Gas Emissions

The proposed project’s greenhouse gas emissions would be less than significant and no mitigation measures are required. For informational purposes, GHG emissions of the proposed project were estimated using CalEEMod version 2022.1.1.16, consistent with the modeling of Alternative 4 emissions. These estimates are not intended to supersede the GHG modeling provided in Chapter 8.0, *Greenhouse Gas Emissions*, of the Draft SEIR. Rather, they are intended to standardize the emissions modeling outputs for equitable comparison within this alternatives analysis. The proposed project would result in a total of 617 MT/year of CO_{2e} during construction and 1,005 MT/year of CO_{2e} during operation (please refer to Table 17-7 and Table 17-8).

As shown in Table 17-7 and Table 17-8 above, Alternative 4 would generate approximately 669 MT/year of CO_{2e} during construction and 685 MT/year of CO_{2e} during operation. Neither the County of Monterey, MBARD, nor any other state or applicable regional agency has adopted a numerical significance threshold for assessing GHG emissions that is applicable to the project. Although emissions associated with Alternative 4 would be greater than the proposed project during construction, operational GHG emissions would be reduced as compared to the proposed project. Alternative 4 would also result in greenhouse gas emissions that would be less than significant and no mitigation measures would be required. Furthermore, based on overall reduced

development on the site, greenhouse gas. Overall, GHG emission impacts from Alternative 4 would be less than the proposed project.

Transportation and Traffic

As a combined assisted living facility (100 beds) and detached senior adult housing units (26), based on ITE trip generation rates for each category, the proposed project would generate approximately 362 daily trips (266 for assisted living facility and 96 for senior adult housing units). The proposed project would result in less-than-significant impacts to area intersections and roadways segments of River Road. However, the proposed project would result in a significant and unavoidable impact of adding additional traffic to SR 68 in the AM and PM peak hours.

Based on ITE trip generation rates for assisted living facilities, Alternative 4 would generate approximately 266 daily trips, as compared to 362 daily trips of the proposed project. Alternative 4 would result in fewer impacts to traffic than the proposed project. However, Alternative 4 would also result in a significant and unavoidable impact.

Water Supply

The proposed project would have an estimated water demand of 11.376 AFY. Demand for water supply of Alternative 4 would be less than the proposed project, based on the overall reduction in development on the project site, reflecting an overall reduced water demand for the site. The estimated water demand for Alternative 4 would be 8.5 AFY. Alternative 4 would result in a less-than-significant impact on water supply, however to a lesser extent than the proposed project.

17.3 Alternatives Considered But Rejected

An alternative site was considered, but rejected from further consideration. The site is considered to be an appropriate location for the proposed project based upon the specific plan land use designation, County zoning designations, and the space available to allow the creation of a tranquil, park-like setting while also being located in a neighborhood setting. The proposed location also offers nearby amenities including hospitals and doctors on Romie Lane in west south Salinas, shopping, and regional roadway access.

Having an alternative access to the project site was also considered as an alternative, but rejected from further consideration. Alternative access either directly from River Road or as a new internal subdivision roadway would not decrease impacts of the proposed project and may result in increased impacts as compared to the proposed project, such as increased traffic, visual, biological, and impacts to recreational areas associated with entry from River Road.

17.4 Comparison of Alternatives

The alternatives are summarized and compared in a matrix format in ~~Table 17-1, Project Alternatives Summary.~~ Table 17-9.

~~Table 17-1~~ Table 17-9 Project Alternatives Summary

<u>Environmental Topic</u>	<u>Alternative 1: No Project/No Development</u>	<u>Alternative 2: No Project/ Min. Development</u>	<u>Alternative 3a: No Project/ Existing Zoning (40-Lot Subdivision)</u>	<u>Alternative 3b: Reduced No Project/ Existing Zoning (Up to a 30-Lot Subdivision)</u>	<u>Alternative 4: Reduced Project</u>
----------------------------	---	--	---	---	---

River View at Las Palmas Assisted Living Senior Facility Project

Aesthetics	-	-	=	=	-
Air Quality	-	-	=	=	-
Biological Resources	-	-	=	=	=
Greenhouse Gas Emissions	-	-	=	=	-
Transportation and Traffic	-	-	+	=	-
Water Supply	-	-	+	=	-
Project Objectives	Not Met	Not Met	Not Partially Met	Partially Met	Partially Met

Source: EMC Planning Group 2017

Note: (-) ~~less-reduced impact~~, (=) similar impact, (+) greater impact

The no project/no development alternative (Alternative 1) would result in no potential adverse environmental impacts, but would not meet any of the proposed project objectives. The no project/minimum development alternative (Alternative 2) would result in less environmental impacts than the proposed project, but would not meet any of the proposed project’s objectives. The no project/existing zoning (40-unit subdivision) alternative (Alternative 3a) would result in lesser or a similar level of impacts as the proposed project; however, and would not meet the objectives of the proposed project for the provision of housing. The reduced no project/existing zoning (30-unit subdivision) alternative (Alternative 3b) would result in less environmental impacts than the proposed project, and would meet most of the objectives of the proposed project. The reduced project (Alternative 4) would have an overall reduction in intensity of potential impacts based on the overall reduction in development on the project site, but the reduced project alternative would only partially meet the objectives of the proposed project and may prove to be economically infeasible. Therefore, the environmentally superior alternative that would partially meet the objectives of the proposed project would be the reduced no project/existing zoning (30-unit subdivision) alternative (Alternative 3b). ~~reduced project alternative.~~

18.0 Sources

Monterey Bay Air Resources District (MBARD). 2008. CEQA Air Quality Guidelines. <https://www.mbard.org/files/0ce48fe68/CEQA+Guidelines.pdf> (accessed August 2023).

Monterey Peninsula Water Management District. 2022. 2022 Supply and Demand Forecast. September 19, 2022. <https://www.mpwmd.net/wp-content/uploads/2022-Supply-and-Demand-Forecast-w-Attachments-1.pdf> (accessed August 2023).

Exhibit G - Appendix A

This page intentionally left blank.

Keith Higgins
Traffic Engineer

**RIVERVIEW AT LAS PALMAS RESIDENTIAL SUBDIVISION
TRANSPORTATION IMPACT ANALYSIS**

DRAFT REPORT

MONTEREY COUNTY, CALIFORNIA

Prepared for
Riverview at Las Palmas, LLC
Carmel, CA 93923

Prepared by
Keith Higgins, Traffic Engineer
Gilroy, CA 95020

January 19, 2022

TABLE OF CONTENTS

1 INTRODUCTION..... 1

1.2 Scope of Work..... 1

1.3 Criteria for Determination of Significance of Project Impacts..... 2

1.4 Level of Service Standards 2

1.5 Traffic Operation Evaluation Methodologies 2

1.6 Significance Criteria..... 3

1.7 Funding for Transportation Improvements 4

2 EXISTING TRAFFIC CONDITIONS..... 5

2.1 Existing Roadway Network..... 5

2.2 Existing Intersection Operations 5

2.3 Existing Road Segment Operations 6

2.4 Existing Transit Service..... 7

2.5 Existing Bicycle Facilities 7

3 PROJECT TRIP GENERATION, DISTRIBUTION, AND ASSIGNMENT 8

3.1 Project Trip Generation..... 8

3.2 Project Trip Distribution and Assignment 9

4 EXISTING PLUS PROJECT TRAFFIC CONDITIONS 10

4.1 Existing Plus Project Intersection Operations 10

4.2 Existing Plus Project Road Segment Operations..... 10

5 CUMULATIVE PLUS PROJECT TRAFFIC CONDITIONS 15

5.1 2030 Cumulative Traffic Volume Forecasts 15

5.2 Cumulative Plus Project Traffic Volumes 15

5.3 Cumulative Plus Project Intersection Operations..... 15

5.4 Cumulative Plus Project Road Segment Operations 16

**6 PROJECT AND CUMULATIVE IMPACTS AND CORRESPONDING
RECOMMENDED IMPROVEMENTS 19**

6.1 Project Impacts and Mitigations 19

6.2 Cumulative Impacts and Mitigations..... 19

6.3 Cumulative Improvements.....20

EXHIBITS

1. Project Location Map
2. Project Site Plan
3. Study Intersections
4. AM & PM Peak Hour Volumes and Project Trip Assignment Using Las Palmas 1 Trip Rates
5. AM & PM Peak Hour Volumes and Project Trip Assignment Using ITE Single Family Detached Trip Rates
6. Intersection Levels of Service
7. Project Trip Generation
8. Project Trip Distribution

APPENDICES

- A Level of Service Description for Signalized Intersections
- B Traffic Count Data
- C Level of Service Calculation Worksheets

Riverview at Las Palmas Subdivision Traffic Impact Analysis

1 INTRODUCTION

This traffic study analyzes the impacts associated with the development of the Riverview at Las Palmas Residential Subdivision (Project) in Monterey County, immediately west of the Las Palmas 1 residential neighborhood. The project is proposed to include 28 single family homes with access via an extension of Woodridge Court. **Exhibit 1** shows the location of the proposed project. The proposed site plan is included as **Exhibit 2**.

1.2 Scope of Work

This study is an update of the “Riverview at Las Palmas Senior Housing Traffic Impact Analysis – Draft Report,” Keith Higgins Traffic Engineer, June 20, 2017 (Senior Housing Traffic Study). It includes the evaluation of the following intersections and road segments:

Intersections:

1. Reservation Road / Highway 68 WB Ramps
2. River Road / Highway 68 EB Ramps
3. Las Palmas Road / River Road

Road Segments:

1. Highway 68 between Laureles Grade and the Spreckels Boulevard Interchange

The study intersections are shown in **Exhibit 3**. Beyond the limits of the study area, the project trips will disperse onto various local streets and roads or onto regional facilities. The local intersections included in the analysis were identified as potentially experiencing the greatest impact from the project.

Weekday AM and PM peak hour traffic operations are analyzed for the following conditions:

1. Existing Conditions
2. Existing Plus Project Conditions
3. Cumulative Plus Project Conditions

Las Palmas 1 Entrance Traffic Operations:

The Project will increase traffic at the existing Las Palmas 1 security gate. An analysis of the effect of the Project on queuing and the potential of queue spillback onto River Road is provided.

1.3 Criteria for Determination of Significance of Project Impacts

As of July 1, 2020, new CEQA guidelines have replaced congestion-based metrics, such as auto delay and level of service, with Vehicle Miles Traveled (VMT) as the basis for determining significant impacts, unless the guidelines provide specific exceptions. However, because this project is still being reviewed under the policies in place in 2017 with the "Riverview at Las Palmas Senior Housing Traffic Impact Analysis Administrative Draft Report," Keith Higgins Traffic Engineer, June 20, 2017 (included in the "Riverview at Las Palmas Assisted Living Senior Project Subsequent EIR prepared in 2017, circulated for public review from March 12, 2018 through April 25, 2018 and certified February 12, 2020) the impact analysis is based on the auto delay and level of service criteria in place at that time.

1.4 Level of Service Standards

Intersection traffic operations were evaluated based on the Level of Service (LOS) concept, and the LOS standard adopted by Monterey County and Caltrans for each intersection. LOS is a qualitative description of an intersection's or road segment's operation, ranging from LOS A to LOS F. Level of service "A" represents free flow uncongested traffic conditions. Level of service "F" represents highly congested traffic conditions with what is commonly considered unacceptable delay to vehicles at intersections. The intermediate levels of service represent incremental levels of congestion and delay between these two extremes. All three study intersections are signalized. LOS descriptions for signalized intersections are included as **Appendix A**.

The study area falls within the jurisdiction of two public agencies, Monterey County and Caltrans. Level of service standards and impact significance criteria adopted by each public agency have been used as appropriate.

For this study, the following level of service thresholds have been used:

1. The County of Monterey LOS "D" standard has been applied to intersections under the jurisdiction of the County of Monterey.
2. The Caltrans level of service standard is the LOS C/D threshold. The Caltrans LOS C/D standard has been applied to state-controlled intersections and road segments.

1.5 Traffic Operation Evaluation Methodologies

Intersection traffic operations were evaluated using the Synchro© traffic analysis software (Version 10) using both the 2010 and 2000 Highway Capacity Manual (HCM) methodologies. The average delay is then correlated to a level of service. For two-way stop-controlled intersections, only the vehicle delay for side street traffic is analyzed. LOS for each side street movement is based on the distribution of gaps in the major street

Riverview at Las Palmas Subdivision Traffic Impact Analysis

traffic stream and driver judgment in selecting gaps. Improvements are warranted when a side street approach reaches LOS F for two-way stop-controlled intersections.

When using the HCM 2010 and 2000 methods for the analysis of signalized and all-way stop-controlled intersections, the overall intersection delay is used to determine LOS.

1.6 Significance Criteria

The following significance criteria are used in this study:

County of Monterey

A significant impact at a signalized study intersection is defined by the “Monterey County Guide for the Preparation of Traffic Impact Studies,” Monterey County Resource Management Agency – Public Works Department, March 28, 2014, to occur under the following conditions:

Signalized Intersections:

A significant impact would occur if a signalized intersection operating at LOS A, B, C, or D degrades to E or F. For intersections already operating at unacceptable level E, a significant impact would occur if a project increases the critical movement’s volume-to-capacity ratio 0.01 or more during peak hours. If the intersection is already operating at LOS F, any increase (one vehicle) in the critical movement’s volume-to-capacity ratio is considered significant.

One- or Two-Way Stop-Controlled Intersection:

A significant impact would occur at a side-street stop-controlled intersection if the side-street currently operating at LOS A, B, C, D or E pre-Project degrades to LOS F with Project traffic; or

If any traffic signal warrant is met with the addition of Project traffic; or

For side-streets already operating at LOS F under pre-Project conditions, the addition of any Project traffic during the deficient peak hour would be considered significant, regardless of its effects on delay.

Caltrans

In the “Guide for the Preparation of Traffic Impact Studies,” State of California Department of Transportation, December 2002, any degradation in the performance measure below the cusp of C/D is considered a significant impact. If a facility is currently operating at or below LOS D, then any trips added represent a potential impact, and the performance measure should be brought back to predevelopment conditions. While a single trip added to a degraded facility is not usually reflected in the performance measure, Caltrans reserved the ability to consider a single trip as an impact.

1.7 Funding for Transportation Improvements

TAMC Measure X

In November 2016, Monterey County voters approved a 30-year, 3/8 cent sales tax measure to fund a broad range of transportation improvements. A total of \$50,000,000 has been earmarked for Highway 68 improvements. This will be supplemented by State and Federal funds. TAMC is currently conducting corridor studies in cooperation with Caltrans to identify improvement options and to focus on options that will provide the most significant benefits to residents and the travelling public. Secondary benefits along Highway 68 will also be provided by the Marina-Salinas Multimodal Corridor improvements along Blanco Road, Reservation Road, and Imjin Parkway. This is an alternate commute route to Highway 68.

TAMC Regional Development Impact Fee

The Transportation Agency for Monterey County (TAMC) and its member jurisdictions have adopted a county-wide, regional development impact fee (RDIF) to cover the costs for studies and construction of many improvements throughout Monterey County. This impact fee, which went into effect on August 27, 2008, is applied to all new development within Monterey County. The governing document for the fee is the *Regional Impact Fee Nexus Study Update* (March 26, 2008) prepared by Kimley-Horn Associates, Inc. *The Regional Impact Fee Nexus Study Update* was updated again in 2018. The latest Strategic Expenditure Plan was prepared in 2020.

Transportation improvements in the immediate vicinity of the Project partially funded by the RDIF include the following.

1. Davis Road South - widening Davis Road to four lanes and constructing a four-lane bridge over the Salinas River.
2. SR 68 (State Route 68) Commuter Improvements. This will likely involve roundabouts at major intersections along SR 68 from Reservation Road to Highway 1. SR 68 may also be widened to four lanes for about one mile from the Toro Park interchange. Major funding for this project will be provided by the TAMC Sales Tax Measure and other

Monterey County Traffic Impact Fee

Monterey County also has a traffic impact fee which is described the "Monterey Countywide Traffic Impact Fee Nexus Study," Kimley Horn, August 1, 2014.

Transportation improvements in the vicinity of the Project include the following.

1. G-17 Widening (Reservation Road) - Widen to four travel lanes with Class II bike lanes on Reservation Road from Davis Road to SR-68.
2. Harris Road Widening - Widen to four lanes on Harris Road from Harris Court to Salinas City Limit.

2 EXISTING TRAFFIC CONDITIONS

This section describes the existing street network relevant to the proposed project and the existing operational traffic conditions.

2.1 Existing Roadway Network

The major roadways in the vicinity of the proposed project include Highway 68, Reservation Road and River Road. These facilities are described below:

Highway 68 (SR 68) connects State Route 1 in Monterey and US 101 in Salinas. It is a 2-lane rural highway with a speed limit of 55 mph between SR 1 and just south of the Portola Drive interchange and carries about 25,000 vehicles per day. Highway 68 is a 4-lane freeway with 65 mph speed limit between the Portola Drive and Spreckels Boulevard interchanges where it carries about 35,000 vehicles per day. Highway 68 is a 4-lane divided highway with 55 mph speed limit from the Spreckels Boulevard interchange to Blanco Road in the City of Salinas where it carries about 28,500 vehicles per day. Inside the City of Salinas SR 68 becomes an arterial along South Main Street and John Street. It serves as a commuter and scenic tourist route between Salinas and the Monterey Peninsula.

Reservation Road is a two-lane rural road that connects Highway 68 to the City of Marina. South of Highway 68, Reservation Road becomes **River Road**, which is a 4-lane road from the Highway 68 / Reservation Road interchange to Las Palmas Road. It narrows to 2 lanes just east of Las Palmas Road. The River Road/Las Palmas Road and River Road/Las Palmas Parkway intersections are signalized. River Road provides access to residential neighborhoods and carries about 13,000 vehicles per day. The Highway 68 ramp intersections with Reservation Road and River Road are signalized.

2.2 Existing Intersection Operations

Weekday AM and PM peak hour turning movement counts at the study intersections were conducted in March and May 2017. The counts were reviewed and, where appropriate, balanced between intersections. Year 2017 peak hour traffic volumes are presented in **Section A** on **Exhibits 4 and 5**. Raw traffic count data is included in **Appendix B**.

The 2017 volumes are valid in 2021 because 2021 traffic volumes have generally decreased on roads in the study area since 2017, as indicated on **Table 1** on the following page. The only exception is Highway 68 east of the Reservation Road – River Road interchange, which is a four-lane freeway/expressway. It is understood that 2020 was an unusual year due to the Covid-19 pandemic. However, there has been a general annual decrease in traffic volumes since 2017 as well. 2016 volumes are included to provide additional recent historical context. Overall, 2017 appears to have experienced the highest volumes in any of the past five years, again with the exception of Highway 68 east of the Reservation Road – River Road interchange.

Riverview at Las Palmas Subdivision Traffic Impact Analysis

2021 daily traffic volumes will not be available from Caltrans or Monterey County Public Works until late Spring or early Summer of 2022. It is not anticipated that traffic volumes will exceed traffic volumes occurring in 2017 because little to no development has occurred in the past four years in the vicinity of Las Palmas or along the Highway 68 corridor. Also, traffic patterns have not fully returned to pre-pandemic conditions.

All three study intersections operate at acceptable level of service C or better under existing conditions and no improvements are recommended. Intersection levels of service are summarized in **Exhibit 6**. LOS calculation worksheets are included as **Appendix C**.

Road Segment	Year					% Change 2017 to 2020
	2016	2017	2018	2019	2020	
A. Highway 68						
1. W of River Rd.	25,700	27,900	25,000	22,300	25,000	-10.4%
2. E of River Rd.	29,800	32,400	29,000	34,100	35,000	+8.0%
B. Reservation Rd.						
1. N of Portola	9,600	10,400	10,300	9,900	9,200	-11.5%
C. River Rd.						
1. Portola to Riverview Ct.	14,100	15,100	14,200	13,100	12,000	-20.5%
2. Riverview Ct. to Berry Dr.	13,000	14,300	13,000	12,800	11,500	-19.6%

Table 1 – Daily Traffic Volumes on Area Roadways (2016-2020)

2.3 Existing Road Segment Operations

According to the 2010 Monterey County General Plan Environmental Impact Report, River Road operated in 2008 at LOS C with an Average Daily Traffic (ADT) of 14,810. The 2016 ADT was 14,100 between Highway 68 and Las Palmas Road. River Road operated at LOS D from Las Palmas Road to Las Palmas Parkway (2008 ADT of 11,750 and 2016 ADT of 13,000), according to the 2010 Monterey County General Plan Environmental Impact Report. Daily traffic volumes in 2016 were very similar to 2008 volumes.

Evening peak hour traffic volumes counted in 2017 for this study totaled 1,492 north of Las Palmas Road and 1,367 south of Las Palmas Road. Evening peak hour volumes generally represent about 10% of the daily total, so they are consistent with the 2016 daily volumes. River Road continues to operate at an acceptable level of service.

Highway 68 operates at LOS F according to the Monterey County 2010 General Plan. The Transportation Agency for Monterey County (TAMC), Caltrans and the County of Monterey has programmed major capacity and safety improvements to Highway 68, including roundabouts at currently signalized intersections. The candidate

Riverview at Las Palmas Subdivision Traffic Impact Analysis

improvements were identified in the “SR 26 Scenic Highway Plan,” August 2017. Measure X, the Transportation Safety & Investment Plan is a sales tax measure that was approved by Monterey County voters in November 2016 provides about \$50 million towards Highway 68 improvements for congestion relief and safety improvements. The TAMC Regional Development Impact Fee allocates an additional \$4 million toward these improvements. Funding will also be provided by various State and Federal sources.

2.4 Existing Transit Service

The primary public transit service in the County of Monterey is provided by Monterey-Salinas Transit (MST). MST focuses on improving operational conditions through established bus routes and schedules that efficiently meet travel demands, reduce travel times, improve service reliability, and encourage bike-and-ride initiatives. All MST buses are wheelchair accessible and equipped with bike racks. In the vicinity of the project, bus routes are provided along Highway 68. There are no MST bus routes provided along River Road or Highway 68 near River Road.

2.5 Existing Bicycle Facilities

The County of Monterey has an adopted Bikeway Plan designating routes along roadways that can be used by bicycling commuters and recreational riders for safe access to major employers, shopping centers and schools. Three basic types of bicycle facilities are described below:

1. Bike path (Class I) - A completely separate right-of-way designed for the exclusive use of cyclists and pedestrians, with minimal crossings for motorists.
2. Bike lane (Class II) - A lane on a regular roadway, separated from the motorized vehicle right-of-way by paint striping, designated for the exclusive or semi-exclusive use of bicycles. Bike lanes allow one-way bike travel. Through travel by motor vehicles or pedestrians is prohibited but crossing by pedestrians and motorists is permitted.
3. Bike route (Class III) - Provides shared use of the roadway with motorists, designated by signs or permanent markings.

Highway 68 and River Road are designated as Cross County Bike Routes on the “2016 Monterey County Bike Map.” Both have shoulders that function as bike lanes. No change in bike facilities is indicated in the Monterey County Active Transportation Plan adopted by the Transportation Agency for Monterey County (TAMC) Board in June 2018.

3 PROJECT TRIP GENERATION, DISTRIBUTION, AND ASSIGNMENT

The procedures for generating and assigning project trips to the local road network are described in this section.

3.1 Project Trip Generation

The Project is proposed to include 28 single family homes, which are expected to have a traffic generation rate similar to the existing homes in the adjacent Las Palmas 1 single family residential development. However, in order to be conservative, project trip generation is estimated based on the trip rate from the original Las Palmas Ranch environmental documents as well as two industry-standard trip generation rates for single family homes. The project trip generation estimate for the Project is estimated using all four sources. These are described below and summarized in **Exhibit 7**.

- a. Project Trip Generation Based on Actual Las Palmas 1 Trip Rates** - Las Palmas Road currently carries about 164 morning peak hour and 155 evening peak hour trips. Traffic counts conducted in November 2013 indicated that Las Palmas Road between River Road and Winding Creek Road carries about 1,837 daily trips. In addition, Riverview Court daily traffic totaled 386, for a grand total of 2,223 for the 313 homes in Las Palmas 1.

Based on the November 2013 counts, the trip generation rate at Las Palmas 1 could be as low as 7.10 daily, 0.52 AM peak hour and 0.50 PM peak hour trips per home. This would result in the Project generating about 199 daily trips with 15 in the AM peak hour and 14 in the PM peak hour.

- b. Project Trip Generation Based on 1983 Las Palmas Specific Plan Trip Rates** – The 1983 Las Palmas Specific Plan assumed that single family development in Las Palmas would generate about 8.0 trips per day per home. This is higher than the rate of 7.5 trips per day home assumed in the “Las Palmas Ranch Traffic Study,” Wilsey & Ham, 1981 and the “Final EIR for the River Road Area of Development Concentration (EIR 81-111), Incorporating the Final EIR for the Las Palmas Specific Plan (EIR 80-100), Grunwald, Crawford & Associates, Certified December 7, 1982. Based on the daily rate of 8.0, the Project is estimated to generate about 224 daily trips with 16 in the AM peak hour and 22 in the PM peak hour, assuming typical AM and PM peak hour percentages of daily traffic.
- c. Project Trip Generation Based on ITE Single-Family Attached Home Trip Rates** – The trip generation rates reported in the Trip Generation Manual, Institute of Transportation Engineers (ITE), 11th Edition, 2021, for Single-Family Attached Homes (ITE Land Use Category 215) are nearly identical to the apparent trip rates at Las Palmas 1. The rates for this land use category include 7.20 daily trips, 0.48 AM peak hour trips and 0.57 PM peak hour trips per home. Based on these rates, the Project is expected to generate about 202 daily trips with 13 in the AM peak hour and 16 in the PM peak hour.

Riverview at Las Palmas Subdivision Traffic Impact Analysis

- d. Project Trip Generation Based on ITE Single-Family Detached Home Trip Rates** - The most conservative trip generation rate for single family home subdivisions is based on Single-Family Detached Homes (ITE Land Use Category 210) which includes rates of 9.43 trips per day with 0.70 AM peak hour trips and 0.94 PM peak hour trips per home. This would result in the Project generating about 264 daily trips with 20 in the AM peak hour and 26 in the PM peak hour.

The daily trip estimate based on the above sources ranges from a low of 199 based on actual counts at Las Palmas 1 to a high of 264 using standard ITE trip generation rates for single family detached residential subdivisions. The AM trip generation estimate ranges from a low of 15 to a high of 20, which is a difference of 5 trips per hour. The PM peak hour trip generation estimate ranges from a low of 14 to a high of 26, which is a difference of 12 trips per hour.

As indicated on **Exhibit 7**, the previous Senior Housing Traffic Study estimated that the Riverview at Las Palmas Senior Housing Project (Senior Housing Project) would generate about 363 daily trips with 10 during the morning peak hour and 21 during the evening peak hour with shift changes during off-peak hours. The current Project will generate between 99 and 164 less daily trips than the Senior Housing Project. The Project will generate between 5 and 10 more AM peak hour trips and between 7 less and 5 more PM peak hour trips than the Senior Housing Project.

Qualitatively, there is no difference between the trip generation estimate based on the low rate using actual counts at Las Palmas 1 and the ITE Single-Family Attached trip generation estimate. It is reasonable to use any of the trip generation estimates. In order to consider the “best” and “worst” case assumptions, the high and low rates are analyzed.

3.2 Project Trip Distribution and Assignment

The project's trip distribution based on existing traffic patterns in the study area is shown graphically in **Exhibit 8**. Project trip assignments at the study intersections are shown on **Exhibit 4, Section B** assuming the Project generates trips at a similar rate as Las Palmas 1. Project trip assignments are also estimated assuming the most conservative ITE Single-Family Detached trip rate, which are shown on **Exhibit 5, Section B**. The following section includes analyses of Project impacts assuming both of the two trip generation assumptions.

4 EXISTING PLUS PROJECT TRAFFIC CONDITIONS

4.1 Existing Plus Project Intersection Operations

Section C in both **Exhibits 4** and **5**, illustrate the existing plus project AM and PM peak hour traffic volumes assuming the respective Las Palmas 1 and the Single-Family Detached trip generation rates.

All of three study intersections are projected to operate at acceptable levels of service under existing plus project traffic conditions and no improvements are recommended with either trip generation assumption. Intersection levels of service are summarized in **Exhibit 6**. Assuming the Single-Family Detached trip rates, the greatest increase in delay would be 0.8 seconds in the PM peak hour at the Reservation Road / Highway 68 Westbound Ramps intersection from 31.3 seconds of average delay under existing conditions to 32.1 seconds of average delay with the Project. This is imperceptible.

Exhibit 6 also provides the levels of service assuming the previous Riverview at Las Palmas Senior Housing project. The Reservation Road / Highway 68 Westbound Ramps intersection was expected to experience an increase from 31.3 seconds of average delay under existing conditions to 32.0 seconds of average delay with the Project. This is an increase of 0.7 seconds. The currently proposed single family home project will result in virtually the same insignificant impacts as anticipated with the previous Senior Housing project.

Project impacts at all study intersections will be insignificant. LOS calculation worksheets are included as **Appendix C**.

4.2 Existing Plus Project Road Segment Operations

a. River Road

The Project will add 14 AM peak hour trips and 13 PM peak hour trips to the four-lane segment of River Road between Highway 68 and Las Palmas Road assuming the Las Palmas 1 trip rates.

The Project will add 19 AM peak hour trips and 25 PM peak hour trips to the four-lane segment of River Road between Highway 68 and Las Palmas Road assuming the Single-Family Detached trip rates.

The Project will add 1 AM and 1 PM peak hour trip to the two-lane segment of River Road between Las Palmas Road and Las Palmas Parkway assuming either of the two trip generation rates. The Project will have no effect on the existing acceptable levels of service.

b. Highway 68

The Project will add between about 2 morning peak hour trips and 2 evening peak hour trips to the two-lane section of Highway 68 immediately west of the Toro Park interchange assuming the same trip generation rate per home as Las Palmas 1. Project traffic will dissipate along the Highway 68 corridor at the many crossroads including Torero Drive, San Benancio Road, Corral de Tierra Road and Laureles Grade, resulting in one or less morning peak hour trip and about one or less evening peak hour trip west of Laureles Grade. Project traffic will probably be at or below one peak hour trip west of Highway 218. This is tabulated at the bottom of **Exhibit 6**.

Under the worst-case Single-Family Detached trip generation assumption, the Project will add about 3 morning peak hour trips and 4 evening peak hour trips to the two-lane segment of Highway 68 immediately west of the Toro Park interchange and 1 to 2 peak hour trips on segments further west. The Project will result in diminishing increases further to the west on Highway 68.

Highway 68 has been determined to currently operate at Level of Service F in the Monterey County General Plan. The Project will exceed the one-trip threshold on the two-lane section of Highway 68 between Toro Park and Highway 218. Using the Level of Service metric for analyzing land development transportation environmental impacts, the addition of a single peak hour trip is a significant impact. This is therefore a significant environmental impact, although the addition of one or two trips in an hour will be imperceptible. Project traffic will have no measurable effect on Highway 68 traffic operations.

The level of effect along Highway 68 is essentially the same regardless of which trip generation estimate is assumed. The level of effect along Highway 68 is also less on a daily basis than the previous Senior Housing Project.

The Project will pay the TAMC Regional Development Impact Fee which will represent the Project's fair share contribution toward Highway 68 improvements and improvements on other regional facilities.

c. Las Palmas 1 Neighborhood Streets

The Project site is located at the end of Woodridge Court. Woodridge Court connects to River Run Road, which connects to Las Palmas Road, which provides access to and from River Road. Woodridge Court and River Run Court are local streets.

Riverview at Las Palmas Subdivision Traffic Impact Analysis

- **Las Palmas Road** functions as a collector street, providing access to and from the project will add traffic to each of these streets. Las Palmas Road currently carries about 164 morning peak hour and 155 evening peak hour trips. Traffic counts conducted in November 2013 indicated that Las Palmas Road between River Road and Winding Creek Road carries about 1,837 daily trips. Riverview Court daily traffic totaled 386, for a grand total of 2,223 for the 313 homes in Las Palmas 1. Based on these counts, the daily trip generation rate is about 7.1 trips per day per home in Las Palmas 1.

Las Palmas Road has no homes along its frontage. Four perpendicular parking stalls are currently located at the west leg of the Winding Creek Road intersection. Otherwise, there is no parking along this street. Two lane collector streets have a capacity of over 10,000 vehicles per day. It has a width of 40 feet, which corresponds to a secondary street in the Monterey County Standard Details, which has a very conservative threshold of carrying up to 3,000 vehicles per day. Level of Service C (LOS C) was the General Plan policy in effect at the time of the approval of the Las Palmas Specific Plan. This threshold therefore corresponds with LOS C.

Assuming this rate applies to all subareas within Las Palmas 1, the daily trip total for Las Palmas Road between Winding Creek Road and River Run Road is about 1,200 vehicles per day. This is 60% below the LOS C capacity normally attributable to collector streets as well as the Monterey County threshold of 3,000 vehicles per day.

The Project will result in Las Palmas Road carrying up to 2,487 vehicles per day between River Road and Winding Creek Road and up to 1,399 vehicles per day between Winding Creek Road and River Run Road. Las Palmas Road will continue to operate at LOS A with addition of Project traffic. These estimates assume the most conservative Project trip generation estimates.

- **River Run Road** carries about 950 vehicles per day between Las Palmas Road and Woodbridge Court. River Run Road is a local street. It has a width of 38 feet, which is about midway between a secondary street (40 feet width) with a LOS C threshold of 3,000 and a tertiary street (34 feet width) with a LOS C threshold of 1,000. This section of street could therefore be considered a hybrid with a LOS C threshold of 2,000 vehicles per day. Functionally, it currently provides the sole access to over 130 homes plus the Corey House and the remaining parcel that is the site of the proposed project (earmarked for approximately 40 homes in the original Las Palmas Specific Plan). River Run Road with the buildout of the current Project would be estimated to carry a maximum of about 1,214 vehicles per day (40% below the LOS C threshold). On that basis, River Run Road will continue to operate at LOS A-B.

Riverview at Las Palmas Subdivision Traffic Impact Analysis

A final consideration for River Run Road is a comparison of anticipated traffic volumes with traffic volume thresholds used by nearby municipalities in neighborhood traffic management and traffic calming policies. Monterey County does not have a policy. The City of Salinas recently adopted the "City of Salinas Neighborhood Traffic Management Program," November 2008, that states on page 61 that, "If traffic volumes on residential streets are projected to be less than 1,500 vehicles per day (vpd), then no action is needed, nor will it be taken." The "City of Seaside Traffic Calming Program", 2011, page 7 states that streets carrying more than 1,600 vehicles per day are eligible for traffic calming. Volumes under 1,600 vehicles per day are within a reasonable level for a residential street. Both policies indicate that collector streets are not eligible for traffic calming. The anticipated worst case volume of 1,214 on River Run Road is below the threshold for both policies and would be considered within an acceptable traffic volume for a local residential street.

- **Woodbridge Court** currently does not provide access to any residences. It has a width of 28 feet, which is similar to a County Loop street. It carries occasional traffic primarily associated with the Corey House and maintenance vehicles. It will carry all of the Project's traffic, which is expected to total about 264 vehicles per day assuming the worst case trip generation rate. This street will carry volumes well within acceptable levels for a County Loop Street, which provides access to 30 homes or less.

The table below summarizes existing and existing plus project daily traffic volumes along the access route between the project site and River Road.

Two intersections exist along the project's access route to and from River Road.

1. The Las Palmas Road / River Run Road intersection is a T-intersection that is stop-controlled on the Las Palmas Road approach. Traffic volumes are well with LOS A on both intersecting streets. No capacity or traffic control improvements are currently warranted. The project will add only incrementally to existing volumes. The Las Palmas Homeowners Association should consider adding stop signs on the River Run Road approaches, since these are the lower volume approaches. This would provide all-way stop control. This would give equal right-of-way priority to the Las Palmas Road approach, which carries the highest volume of the three approaches.
2. The River Run Road / Woodbridge Court intersection has stop control on the River Run Road approach. This is the highest volume approach at the intersection. The Las Palmas Homeowners Association should consider adding stop control on the Woodbridge Court approach to control traffic exiting from the Project. All-way stop control should also be considered.

Riverview at Las Palmas Subdivision Traffic Impact Analysis

Street Name – Segment Limits	Street Classification & LOS C Threshold	No. of Homes Along Frontage	Existing ADT and LOS	Project ADT *	Existing Plus Project ADT-LOS*
Las Palmas Rd – River Rd to Winding Creek	Collector/Secondary – 3,000	0	2,223-A	199/264	2,422-A/ 2,487-A
Las Palmas Rd – Winding Creek to River Run	Collector/Secondary – 3,000	0	1,200-A	199/264	1,399-A/ 1,264-A
River Run Rd – Las Palmas to Woodbridge	Local/an average of Secondary and Tertiary - 2,000	2	950-A	199/264	1,149-A/ 1,214 A
Woodbridge Ct – River Run to Project	Loop - 300	0	0 (nil)-A	199/264	199-A/ 264-A

Note: * - Existing Plus Project ADT and LOS – Based on Las Palmas 1 Trip Rates / Based on ITE Single Family Detached Trip Rates

Table 2 – Las Palmas Neighborhood Daily Volumes and Quality of Life Levels of Service

The above stop-sign additions are not required to be implemented by the Project because the Project does not result in an operational deficiency at these intersections. They are only recommendations that would provide more clarity regarding right-of-way prioritization.

5 CUMULATIVE PLUS PROJECT TRAFFIC CONDITIONS

This section describes the analysis and results for 2030 cumulative conditions.

5.1 2030 Cumulative Traffic Volume Forecasts

Future traffic growth projections for the study area were derived from 2030 traffic volume projections in the Monterey County 2010 General Plan. This is equivalent to an increase of 15% above existing traffic volumes. This is more conservative than the projections developed for Highway 68 in the *State Route 68 Scenic Highway Plan* being prepared by Kimley-Horn, which were based on the Fort Ord Reuse Authority (FORA) travel demand model that projected slightly less than 10% growth along the Highway 68 corridor between the years 2016 and 2035. The 15% increase is also applied to Las Palmas Road traffic although no development in addition to the Project is anticipated that will be served by Las Palmas Road. It accounts for changes in demographics in the future that could result in a higher trip generation rate for existing Las Palmas 1 residences than current conditions.

5.2 Cumulative Plus Project Traffic Volumes

The trips generated by the proposed project were added to the 2030 cumulative traffic volumes to estimate the cumulative plus project AM and PM peak hour traffic volumes shown in **Exhibits 4** and **5** for the two Project trip generation assumptions.

5.3 Cumulative Plus Project Intersection Operations

Two study intersections are projected to operate at unacceptable levels of service under cumulative plus traffic conditions assuming both Project trip generation assumptions. The average peak hour delay is about 0.2 seconds greater based on the conservative Single-Family Detached trip generation estimate than the delay from the previously proposed Senior Housing project. These are imperceptible differences. Intersection levels of service are summarized in **Exhibit 6**. LOS calculation worksheets are included as **Appendix C**.

1. The Reservation Road / Highway 68 WB Ramp intersection is projected to operate at an unacceptable LOS D during the PM peak hour under cumulative plus project traffic conditions.
2. The River Road / Highway 68 EB Ramp intersection is projected to operate at an unacceptable LOS D during the AM peak hour under cumulative plus project traffic conditions.

Riverview at Las Palmas Subdivision Traffic Impact Analysis

5.4 Cumulative Plus Project Road Segment Operations

River Road is expected to continue to operate at LOS C between Highway 68 and Las Palmas Road and LOS D from Las Palmas Road to Las Palmas Parkway under 2030 Cumulative Conditions, according to the 2010 Monterey County General Plan Environmental Impact Report. These are acceptable levels of service.

As previously stated, Highway 68 has been determined to currently operate at LOS F in the Monterey County 2010 General Plan. The projected 10% increase in traffic volumes under cumulative conditions would exacerbate these conditions.

6 PROJECT IMPACTS ON LAS PALMAS 1 ENTRANCE TRAFFIC OPERATIONS

The Project will increase traffic on Las Palmas Road, which includes a security gate. Currently the entrance is controlled by a security guard only during daylight hours and is not controlled from about 3:30 PM through the rest of the evening. The security guard instead changes to patrol on the subdivision. Based on previous observations in 2017 of traffic at Las Palmas 1, traffic entered unimpeded. Evening peak hour traffic was observed on Thursday, January 6, 2022, to confirm previous observations. No queues or any traffic operational issues were noted during the recent field visit. The security gate was uncontrolled and the security vehicle was observed to be patrolling the subdivision during the field visit.

The Project will only add about 16 entering vehicles in the PM peak hour, which is about one vehicle every four minutes. This is practically imperceptible and is not expected to change traffic operations at the Las Palmas 1 main entrance.

Although there are no existing queuing issues and none are expected in the future based on existing traffic and security procedures, a person could control entering traffic in the future. To determine the potential for vehicle queues spilling onto River Road, a queuing analysis was performed. It assumes that the security gate is manually controlled during the PM peak hour, which is a worst case condition that may not happen.

Morning and evening peak hour traffic entering Las Palmas 1 on Las Palmas Road is tabulated for Existing, Existing plus Project and Cumulative plus Project conditions on **Table 3** on the following page. These are referenced from the peak hour volumes at the River Road / Las Palmas Road intersection illustrated on **Exhibit 5** for the Project worst case trip generation rate of Single Family Detached. It will be noted that the cumulative entrance volumes include a 15% background growth factor as an allowance for increased Las Palmas 1 trip generation in the future if demographic changes occur.

The probability of queue spillover is based on standard queuing theory assuming a random arrival rate for entering traffic during the AM and PM peak hour and a uniform service rate of 600 vehicles per hour (one vehicle every 5 seconds) to be processed through the security entrance. The calculations are included in **Appendix D**.

Under normal circumstance, queues would never extend onto River Road in the AM or PM peak hours with the Project as well as under Cumulative plus Project conditions. The longest queues would probably be 3 vehicles during the PM peak hour when they would occur between 0.5% and 1% of the time. The queue lengths would be qualitatively the same under Cumulative plus Project as Existing conditions.

Riverview at Las Palmas Subdivision Traffic Impact Analysis

Scenario	SB River Rights	NB River Lefts	Total Entering Volumes	Increase Above Existing (Volumes)	Increase Above Existing (Percent)	Probability of Queue Spillover	
						Onto Las Palmas Rd Xwalk (5 cars)	Longest Queue (Cars) Based on 0.5% - 1.0% Probability
Existing							
AM	33	8	41			0.0%	2
PM	97	9	106			0.0%	3
Existing + Project							
AM	40	8	48	5	17%	0.0%	2
PM	112	10	122	8	15%	0.0%	3
Cumulative + Project							
AM	45	9	54	13	32%	0.0%	2
PM	127	11	138	32	30%	0.0%	3

Notes: 1. * - Based on queuing calculations in **Appendix D**.

2. A total of 5 cars are assumed to be able to be stored between the existing gate house and the crosswalk across Las Palmas Road at River Road.
3. A uniform service rate of 600 vehicles per hour (one vehicle every 5 seconds) is assumed, based on the average of the typical service rate of a clear aisle with no control and cashier, flat fee, no gate, and no information given.

Table 3 – Las Palmas Road Gated Entrance Queue Estimates

Apparently, some queuing issues on Las Palmas Road occur during school bus pickup and drop. It is uncertain what the frequency and magnitude of this situation. However, it will not be qualitatively affected by the addition of Project traffic.

6 PROJECT AND CUMULATIVE IMPACTS AND CORRESPONDING RECOMMENDED IMPROVEMENTS

6.1 Project Impacts and Mitigations

a. Project Traffic Operations Impacts

All the study intersections are forecasted to operate at acceptable levels of service under Existing plus Project traffic conditions and no improvements are required. The level of effect is the same or lower than forecasted for the previous Senior Housing project.

Project traffic will have no effect on Highway 68 traffic operations. However, Highway 68 has been determined to currently operate at Level of Service F in the Monterey County General Plan. Monterey County and Caltrans consider the addition of a single peak hour trip to be a significant impact. As discussed in the Existing Plus Project Conditions section of this report, TAMC, Caltrans, and Monterey County have funding and are studying a variety of operational improvements along the corridor.

b. Project Contributions to Transportation Improvements

The project will pay TAMC regional development impact fees that will be able to be applied toward the above Highway 68 improvements. The Project will also pay the Monterey County Traffic Impact Fee. The payment of impact fees will represent an adequate contribution toward improvements to offset the Project's impacts on traffic operations on Highway 68 and elsewhere on the State highway system and nearby County roads.

6.2 Cumulative Impacts and Mitigations

The following study facilities are projected to operate at unacceptable levels of service under cumulative plus traffic conditions.

1. The Reservation Road / Highway 68 WB Ramp intersection is projected to operate at an unacceptable LOS D during the PM peak hour.
2. The River Road / Highway 68 EB Ramp intersection is projected to operate at an unacceptable LOS D during the AM peak hour.
3. Highway 68 is projected to operate at LOS F under cumulative traffic conditions.

The proposed project will contribute incrementally to the above cumulative impacts. The project will add only incrementally to this cumulative impact and should pay a proportionate share of the cost of the following improvements.

6.3 Cumulative Improvements

1. The following improvements would result in acceptable levels of service at the study intersections Impacts 1 and 2 described in Section 6.1 above. These options both appear to be feasible. They will require Monterey County and Caltrans to evaluate the pros and cons of each alternative.

Improvement Option 1: Add a dedicated southbound right-turn lane at the Reservation Road / Highway 68 WB Ramps intersection and a second southbound left-turn lane at the River Road / Highway 68 EB Ramps intersection, or;

Improvement Option 2: Convert the Reservation Road / Highway 68 WB Ramps and River Road / Highway 68 EB Ramps intersections to roundabouts. A roundabout appears to be able to be implemented with no physical constrains at the EB Ramp intersection. However, the WB Ramp intersection would require right-of-way acquisition and construction that would be very close to existing office buildings on the northeast and northwest corners of the intersection. Special attention to this issue would need to be made when evaluating the feasibility of this alternative.

2. TAMC, Caltrans, and Monterey County will be implementing operational improvements to Highway 68 as described in "Section 2.3 Existing Conditions Road Segment Operations." The project will pay TAMC Regional Development Fees, which will represent its fair-share contribution to this improvement.
3. The project will be required to pay TAMC and County of Monterey traffic impact fees, which will represent its share of improvements to offset its contribution to County-wide cumulative impacts.

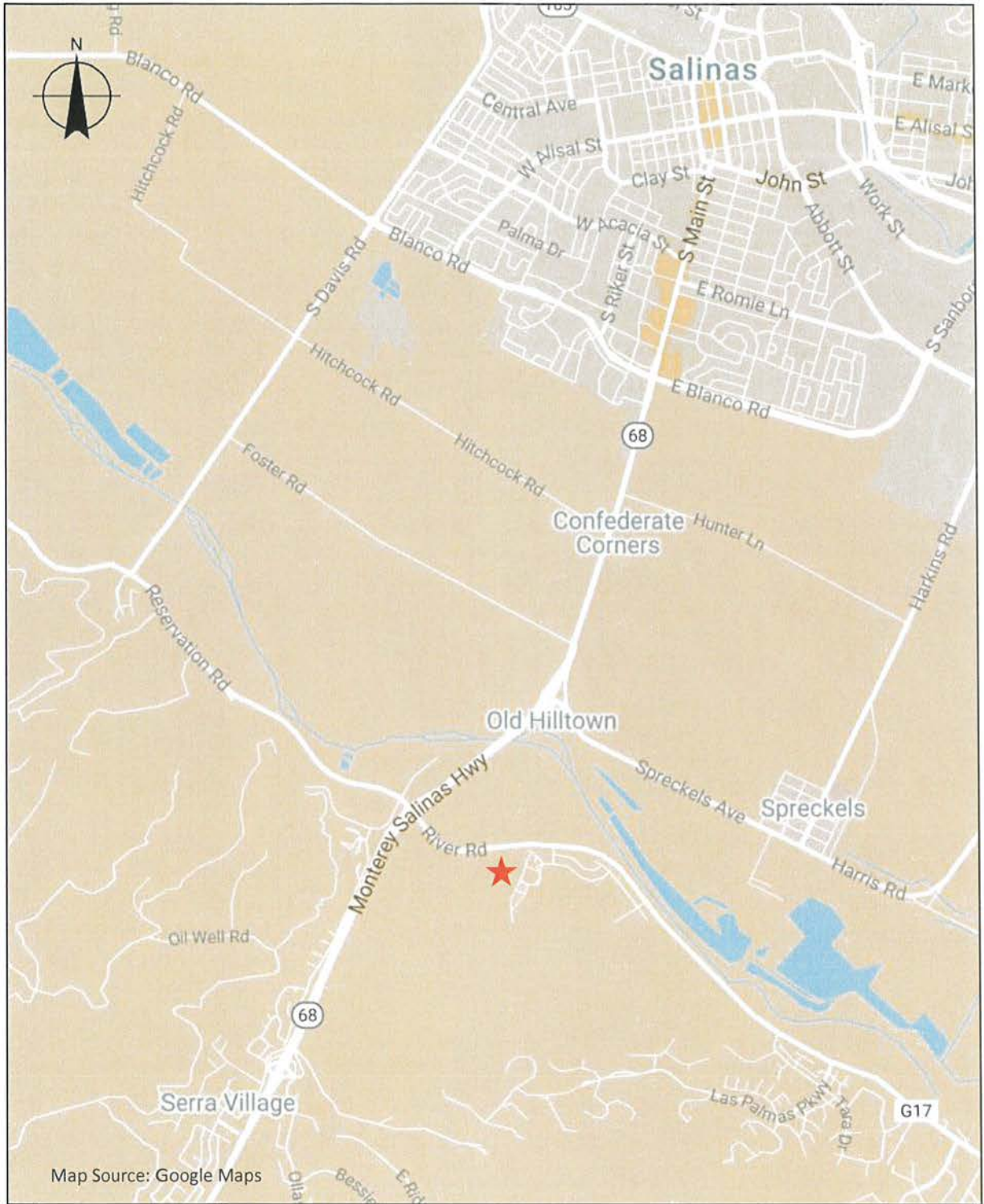

Map Source: Google Maps

LEGEND

★ Project Location

Keith Higgins
Traffic Engineer

Exhibit 1
Project Location Map

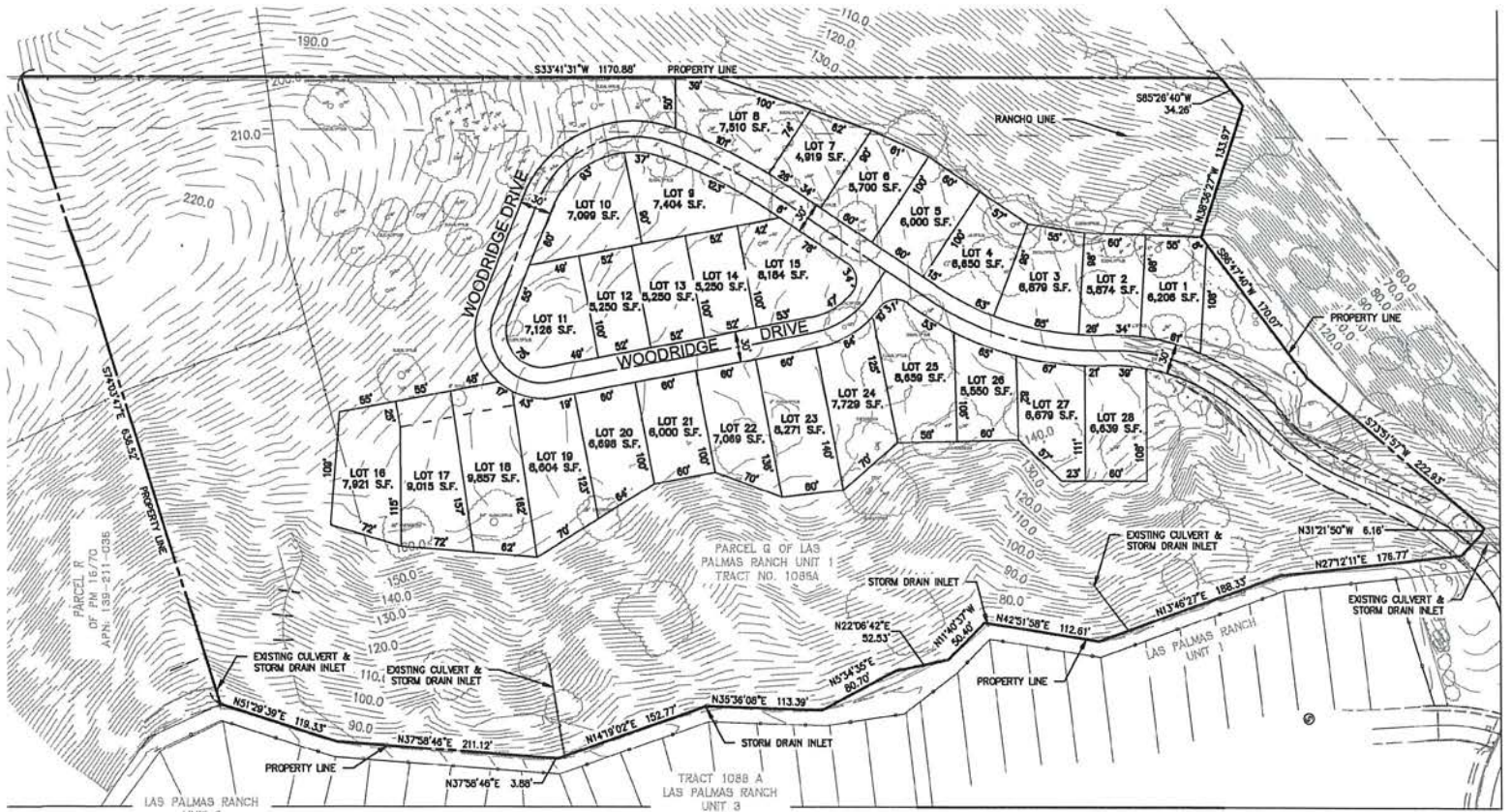

PARCEL R
OF FM 16770
APP. 99-21-038

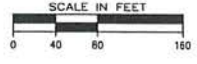

Keith Higgins
Traffic Engineer

Exhibit 2
Project Site Plan

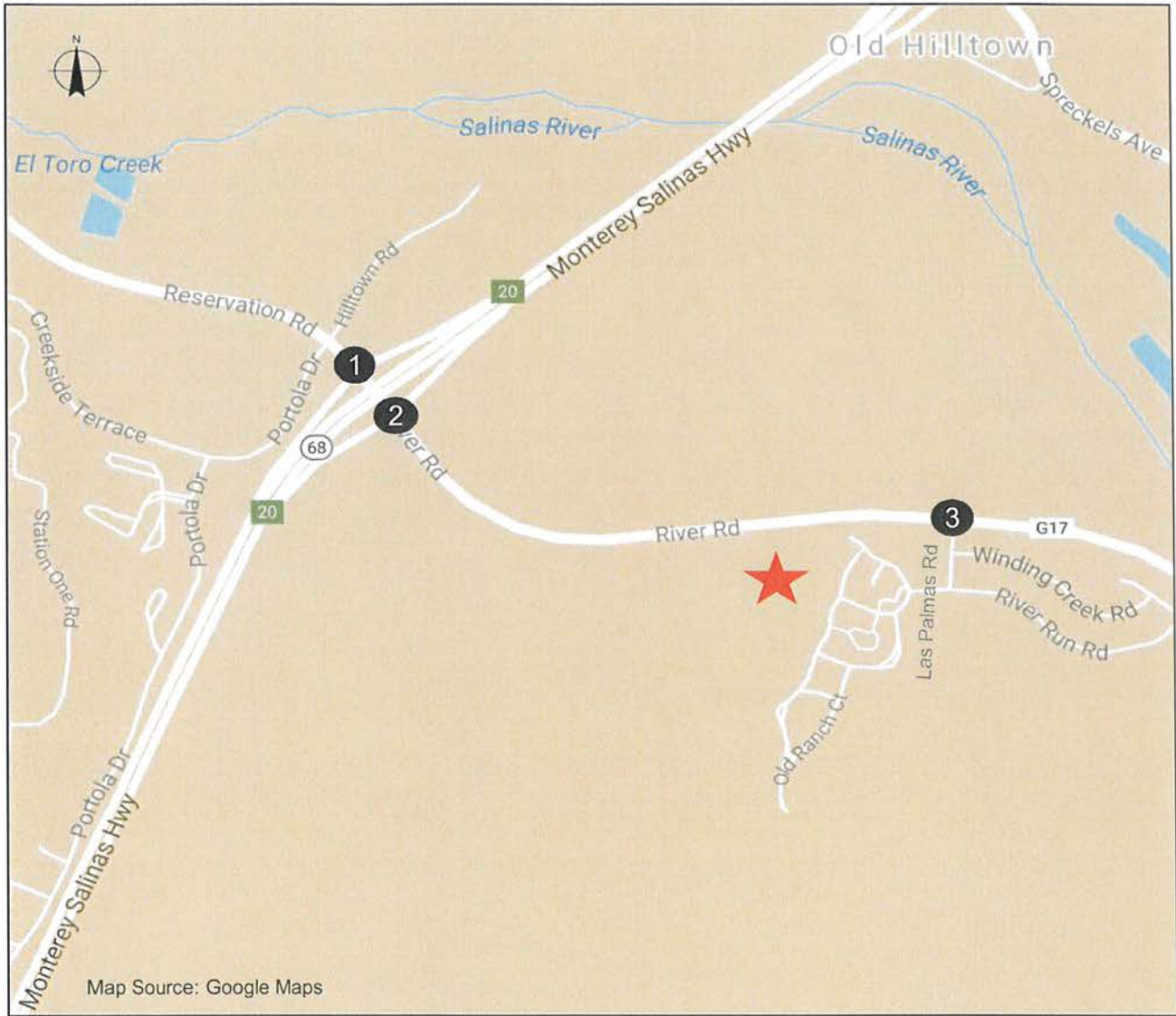

LEGEND



Project Site



Study Intersection

Keith Higgins
Traffic Engineer

Exhibit 3
Study Intersections

A. Existing Conditions

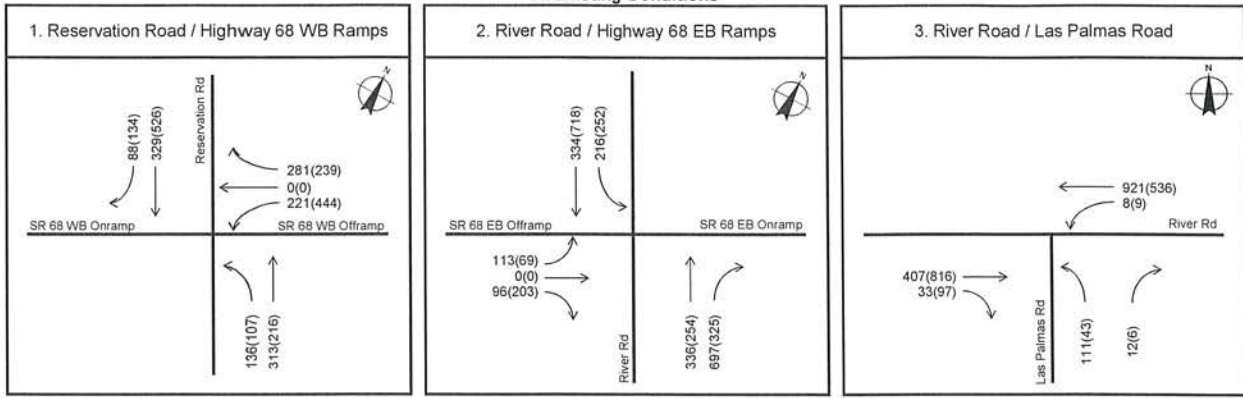

B. Project Trip Assignment

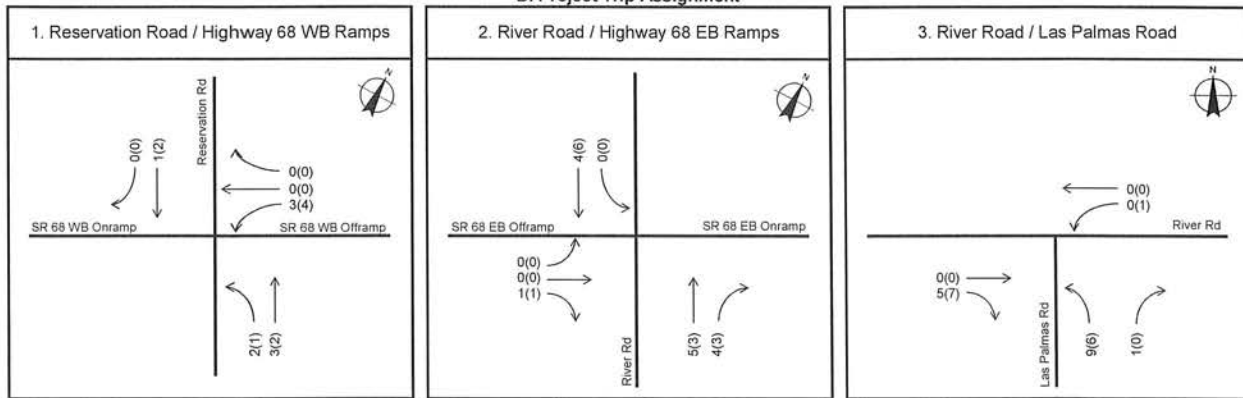

C. Existing Plus Project Conditions

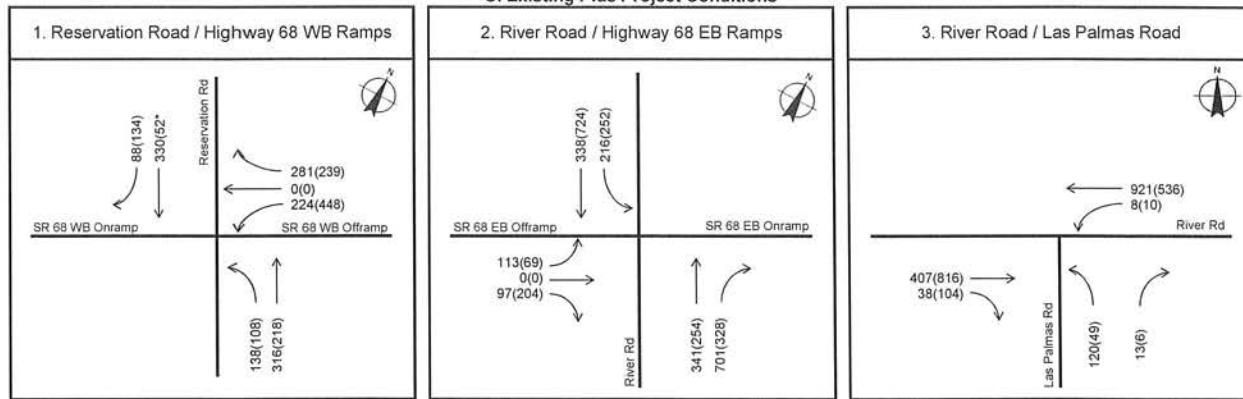

D. Cumulative Plus Project Conditions

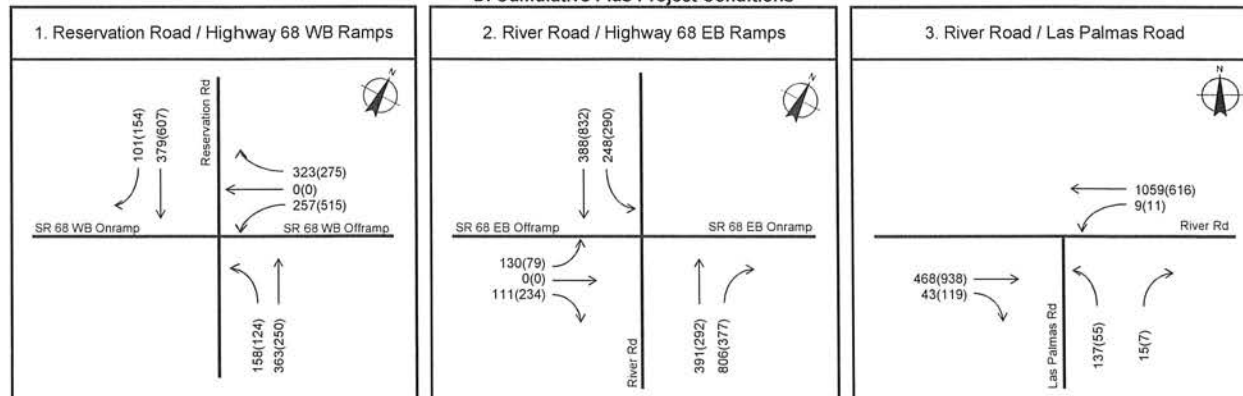

XX (YY) = AM (PM)

A. Existing Conditions

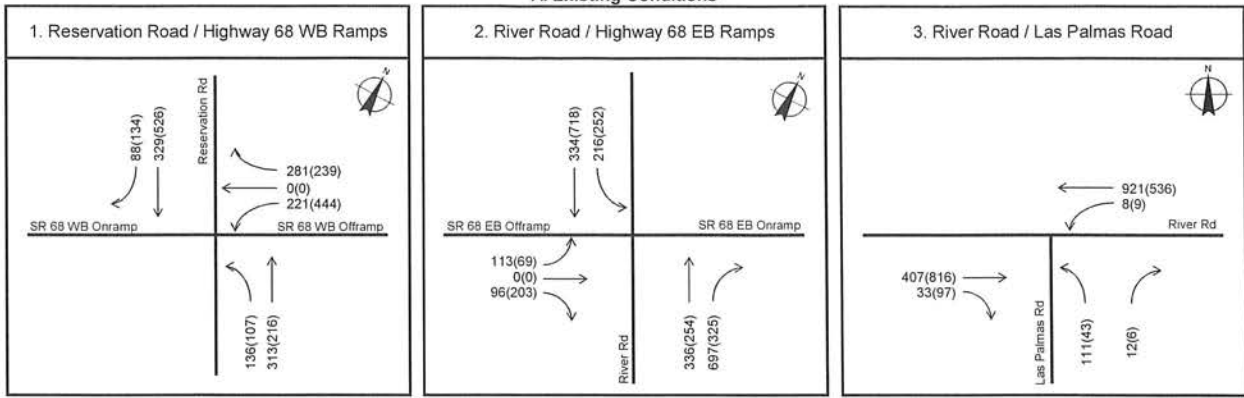

B. Project Trip Assignment

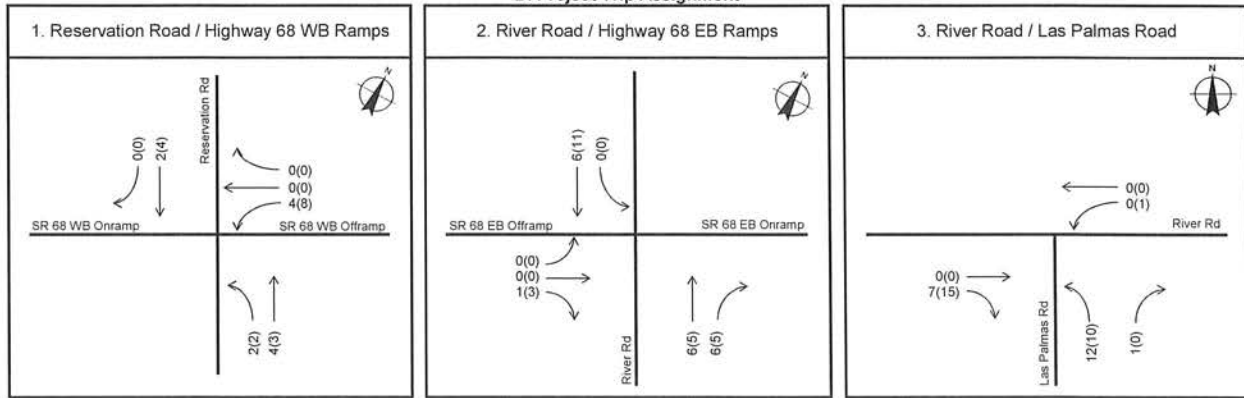

C. Existing Plus Project Conditions

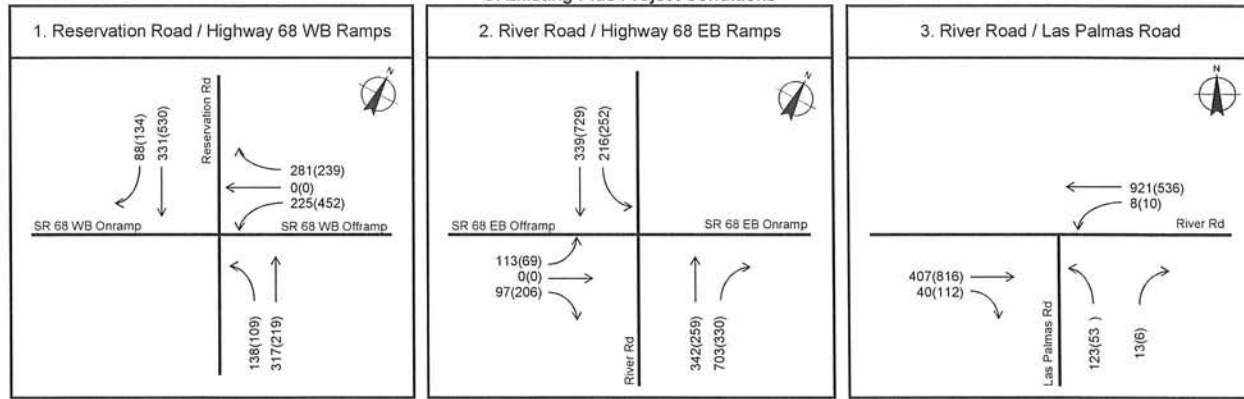

D. Cumulative Plus Project Conditions

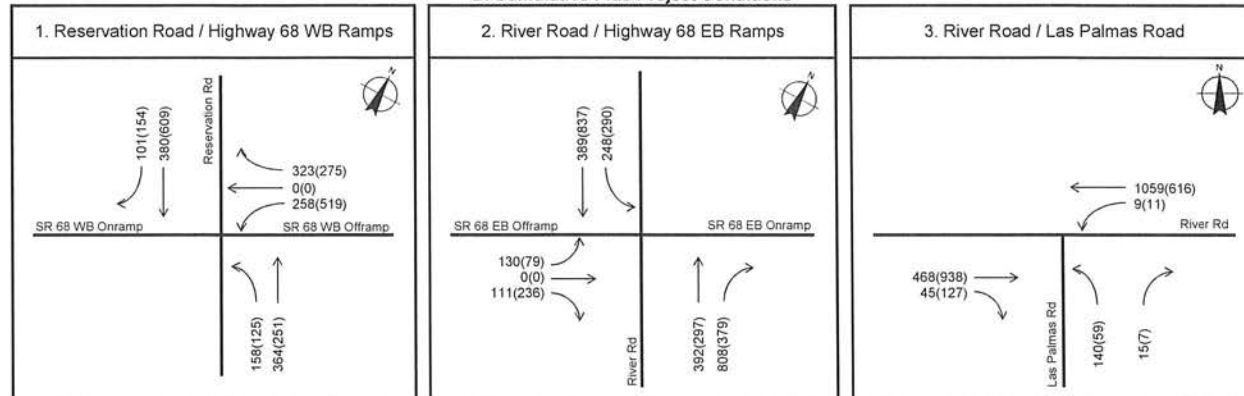

XX (YY) = AM (PM)

Keith Higgins
Traffic Engineer

Exhibit 5
AM & PM Peak Hour Volumes and
Project Trip Assignment -
Single Family Detached

Previous Senior Housing Project

N-S Street	E-W Street	Existing Lane Configuration	Existing Intersection Control	LOS Standard	Existing Conditions				Existing + Project Conditions				Cumulative + Project Conditions			
					AM Peak Hr.		PM Peak Hr.		AM Peak Hr.		PM Peak Hr.		AM Peak Hr.		PM Peak Hr.	
					Delay (sec)	LOS	Delay (sec)	LOS	Delay (sec)	LOS	Delay (sec)	LOS	Delay (sec)	LOS	Delay (sec)	LOS
1	Reservation Road	Highway 68 WB Ramps	Signal	Caltrans C	20.3	C	31.3	C	20.3	C	32.0	C	24.6	C	48.7	D
					Miti 1	Miti 2	20.8	C	31.1	C	20.8	A	31.1	C		
2	River Road	Highway 68 EB Ramps	Signal	Caltrans C	26.3	C	14.5	B	26.5	C	14.6	B	42.7	D	17.8	B
					Miti 1	Miti 2	27.0	C	14.8	B	27.0	A	14.8	A		
3	Las Palmas Road	River Road	Signal	County D	4.9	A	4.2	A	5.0	A	4.4	A	5.3	A	4.4	A

Notes:

- 1 L, T, R = Left, Through, Right
- 2 NB, SB, EB, WB = Northbound, Southbound, Eastbound, Westbound
- 3 Highlighted levels of service exceed jurisdiction's LOS standard.
- 4 Miti 1 = Add SBR at Intersection #1 and 2nd SBL at Intersection #2.
- 5 Miti 2 = Convert Intersections #1 and #2 to roundabouts.

Based on Single Family Trip Rates

N-S Street	E-W Street	Existing Lane Configuration	Existing Intersection Control	LOS Standard	Existing Conditions				Existing + Project Conditions				Cumulative + Project Conditions			
					AM Peak Hr.		PM Peak Hr.		AM Peak Hr.		PM Peak Hr.		AM Peak Hr.		PM Peak Hr.	
					Delay (sec)	LOS	Delay (sec)	LOS	Delay (sec)	LOS	Delay (sec)	LOS	Delay (sec)	LOS	Delay (sec)	LOS
1	Reservation Road	Highway 68 WB Ramps	Signal	Caltrans C	20.3	C	31.3	C	20.4	C	32.1	C	24.7	C	48.7	D
					Miti 1	Miti 2	20.9	C	31.2	C	20.9	A	31.2	C		
2	River Road	Highway 68 EB Ramps	Signal	Caltrans C	26.3	C	14.5	B	26.6	C	14.6	B	42.9	D	17.8	B
					Miti 1	Miti 2	27.1	C	14.8	B	27.1	A	14.8	A		
3	Las Palmas Road	River Road	Signal	County D	4.9	A	4.2	A	5.3	A	4.7	A	5.5	A	4.8	A

Notes:

- 1 L, T, R = Left, Through, Right
- 2 NB, SB, EB, WB = Northbound, Southbound, Eastbound, Westbound
- 3 Highlighted levels of service exceed jurisdiction's LOS standard.
- 4 Miti 1 = Add SBR at Intersection #1 and 2nd SBL at Intersection #2.
- 5 Miti 2 = Convert Intersections #1 and #2 to roundabouts.

Keith Higgins
Traffic Engineer

Exhibit 6
Intersection Levels of Service

PREVIOUS SENIOR HOUSING PROJECT										
TRIP GENERATION RATES ¹	ITE Land Use Code	Daily Trip Rate	AM Peak Hour				PM Peak Hour			
			Peak Hour Rate	% of ADT	% In	% Out	Peak Hour Rate	% of ADT	% In	% Out
Senior Housing - Detached (per unit)	251	3.68	0.22	6%	35%	65%	0.27	7%	61%	39%
Senior Housing - Attached (per unit)	252	3.44	0.2	6%	34%	66%	0.25	7%	54%	46%
Assisted Living (per bed)	254	2.74	0.18	7%	68%	32%	0.29	11%	50%	50%
Nursing Home (per bed)	620	2.74	0.17	6%	69%	31%	0.22	8%	33%	67%
GENERATED TRIPS	Project Size	Daily Trips	Peak Hour Trips	% of ADT	Trips Inbound	Trips Outbound	Peak Hour Trips	% of ADT	Trips Inbound	Trips Outbound
SENIOR HOUSING PROJECT										
Senior Housing - Detached	0 Units	0	0	-	0	0	0	-	0	0
Senior Housing - Attached (Casitas)	26 Units	89	5	6%	2	3	7	8%	4	3
Assisted Care	52 Beds	142	9	6%	6	3	15	11%	8	7
Memory Care (Nursing Home)	48 Beds	132	8	6%	6	2	11	8%	4	7
Total Using Standard ITE Rates		363	22	6%	14	8	33	9%	16	17
Reduction in Peak Hour Traffic by Adjusting Day Shift A Schedule			12		12	0	12		0	12
Total with Adjusted Work Schedules			10		2	8	21		16	5

PROJECT TRAFFIC ASSIGNMENT TO HIGHWAY 68 SEGMENTS	Percent of Total	Total	EB	WB	Total	EB	WB
River Road to Toro Park (4 Lane Section)	17%	1.7	0.3	1.4	3.6	2.7	0.9
Toro Park to Laureles Grade (2 Lane Section)	14%	1.4	0.3	1.1	2.9	2.2	0.7
Laureles Grade to Highway 218 (2 Lane Section)	8%	0.8	0.2	0.6	1.7	1.3	0.4
West of Highway 218 (2 Lane Section)	5%	0.5	0.1	0.4	1.1	0.8	0.3
Highway 218	2%	0.2	0.0	0.2	0.4	0.3	0.1

Note: Trip generation rates published by Institute of Transportation Engineers, "Trip Generation Manual," 9th Edition, 2012.

CURRENT RESIDENTIAL SUBDIVISION PROJECT										
TRIP GENERATION RATES ¹	ITE Land Use Code	Daily Trip Rate	AM Peak Hour				PM Peak Hour			
			Peak Hour Rate	% of ADT	% In	% Out	Peak Hour Rate	% of ADT	% In	% Out
Based on Las Palmas 1 Traffic Counts	N.A.	7.10	0.52	7%	31%	69%	0.50	7%	57%	43%
1983 Las Palmas Ranch Specific Plan	N.A.	8.00	0.56	7%	31%	69%	0.80	10%	57%	43%
Single-Family Attached Housing	215	7.20	0.48	7%	31%	69%	0.57	8%	57%	43%
Single-Family Detached Housing	210	9.43	0.70	7%	26%	74%	0.94	10%	63%	37%
GENERATED TRIPS	Project Size	Daily Trips	Peak Hour Trips	% of ADT	Trips Inbound	Trips Outbound	Peak Hour Trips	% of ADT	Trips Inbound	Trips Outbound
PROPOSED PROJECT - RESIDENTIAL SUBDIVISION WITH VARIOUS TRIP GENERATION ASSUMPTIONS										
Based on Las Palmas 1 Traffic Counts	28 Homes	199	15	8%	5	10	14	7%	8	6
1983 Las Palmas Ranch Specific Plan	28 Homes	224	16	7%	6	10	22	10%	13	9
Single-Family Attached Housing	28 Homes	202	13	6%	5	8	16	8%	9	7
Single-Family Detached Housing	28 Homes	264	20	8%	7	13	26	10%	16	10
CHANGE FROM PREVIOUS SENIOR HOUSING PROJECT										
Based on Las Palmas 1 Traffic Counts			-164	5	3	2	-7		-8	1
1983 Las Palmas Ranch Specific Plan			-139	6	4	2	1		-3	4
Single-Family Attached Housing			-161	3	3	0	-5		-7	2
Single-Family Detached Housing			-99	10	5	5	5		0	5

LAS PALMAS RANCH SPEC. PLAN TRAFFIC ASSIGNMENT TO HWY 68	Percent of Total	Total	EB	WB	Total	EB	WB
River Road to Toro Park (4 Lane Section)	17%	2.7	1.0	1.7	3.7	2.2	1.5
Toro Park to Laureles Grade (2 Lane Section)	14%	2.2	0.8	1.4	3.1	1.8	1.3
Laureles Grade to Highway 218 (2 Lane Section)	8%	1.3	0.5	0.8	1.8	1.0	0.7
West of Highway 218 (2 Lane Section)	5%	0.8	0.3	0.5	1.1	0.7	0.5
Highway 218	2%	0.3	0.1	0.2	0.4	0.3	0.2

SINGLE FAMILY DETACHED TRAFFIC ASSIGNMENT TO HIGHWAY 68	Percent of Total	Total	EB	WB	Total	EB	WB
River Road to Toro Park (4 Lane Section)	17%	3.4	1.2	2.2	4.4	2.7	1.7
Toro Park to Laureles Grade (2 Lane Section)	14%	2.8	1.0	1.8	3.6	2.2	1.4
Laureles Grade to Highway 218 (2 Lane Section)	8%	1.6	0.6	1.0	2.1	1.3	0.8
West of Highway 218 (2 Lane Section)	5%	1.0	0.4	0.7	1.3	0.8	0.5
Highway 218	2%	0.4	0.1	0.3	0.5	0.3	0.2

SINGLE FAMILY ATTACHED TRAFFIC ASSIGNMENT TO HIGHWAY 68	Percent of Total	Total	EB	WB	Total	EB	WB
River Road to Toro Park (4 Lane Section)	17%	2.2	0.9	1.4	2.7	1.5	1.2
Toro Park to Laureles Grade (2 Lane Section)	14%	1.8	0.7	1.1	2.2	1.3	1.0
Laureles Grade to Highway 218 (2 Lane Section)	8%	1.0	0.4	0.6	1.3	0.7	0.6
West of Highway 218 (2 Lane Section)	5%	0.7	0.3	0.4	0.8	0.5	0.4
Highway 218	2%	0.3	0.1	0.2	0.3	0.2	0.1

Note: Trip generation rates published by Institute of Transportation Engineers, "Trip Generation Manual," 11th Edition, 2021.

Keith Higgins
Traffic Engineer

Exhibit 7
Project Trip Generation

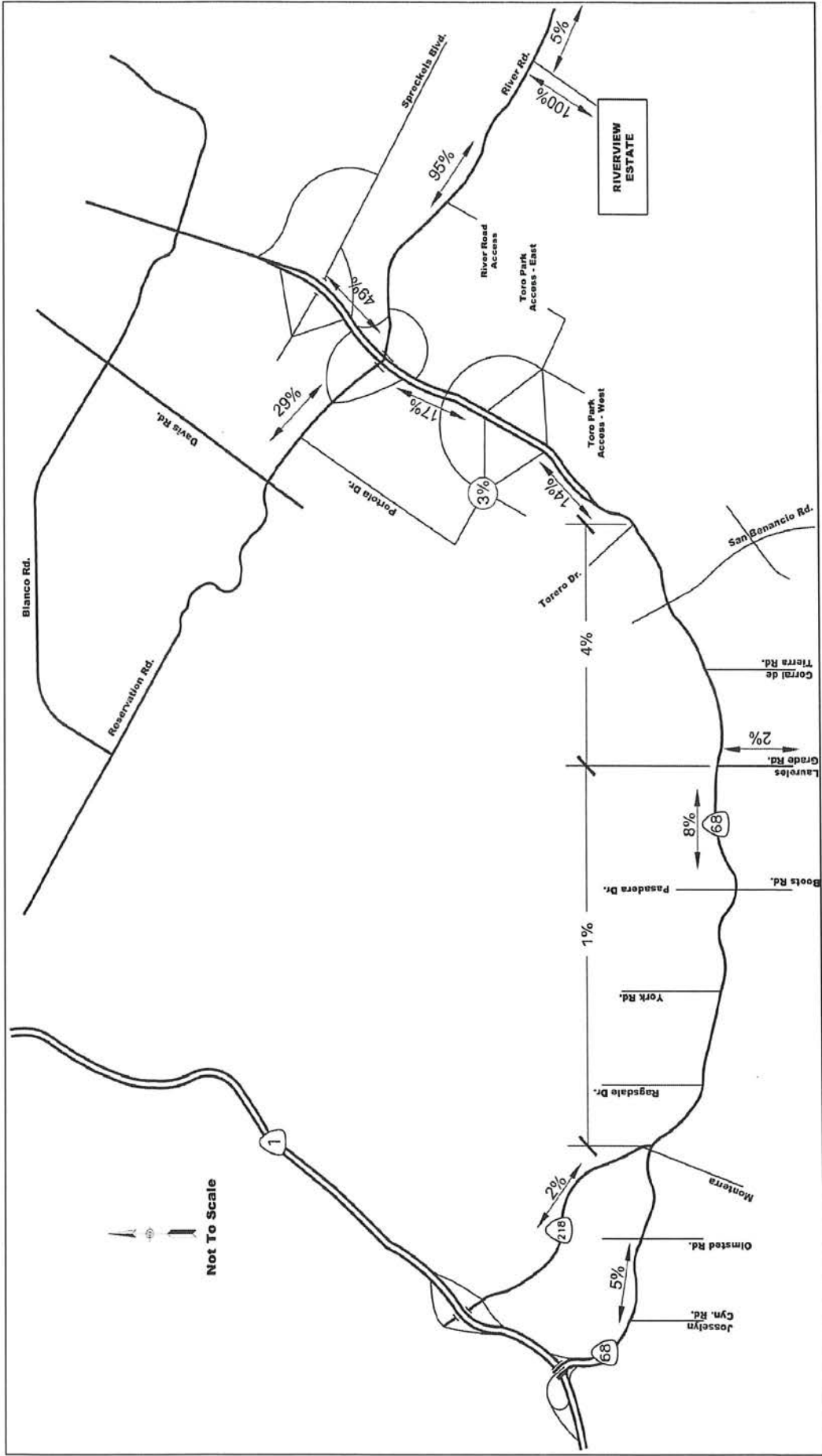

APPENDIX A

LEVEL OF SERVICE (LOS) DESCRIPTION SIGNALIZED INTERSECTIONS

The capacity of an urban street is related primarily to the signal timing and the geometric characteristics of the facility as well as to the composition of traffic on the facility. Geometrics are a fixed characteristic of a facility. Thus, while traffic composition may vary somewhat over time, the capacity of a facility is generally a stable value that can be significantly improved only by initiating geometric improvements. A traffic signal essentially allocates time among conflicting traffic movements that seek to use the same space. The way in which time is allocated significantly affects the operation and the capacity of the intersection and its approaches.

The methodology for signalized intersection is designed to consider individual intersection approaches and individual lane groups within approaches. A lane group consists of one or more lanes on an intersection approach. The outputs from application of the method described in the HCM 2010 are reported on the basis of each lane. For a given lane group at a signalized intersection, three indications are displayed: green, yellow and red. The red indication may include a short period during which all indications are red, referred to as an all-red interval and the yellow indication forms the change and clearance interval between two green phases.

The methodology for analyzing the capacity and level of service must consider a wide variety of prevailing conditions, including the amount and distribution of traffic movements, traffic composition, geometric characteristics, and details of intersection signalization. The methodology addresses the capacity, LOS, and other performance measures for lane groups and the intersection approaches and the LOS for the intersection as a whole.

Capacity is evaluated in terms of the ratio of demand flow rate to capacity (v/c ratio), whereas LOS is evaluated on the basis of control delay per vehicle (in seconds per vehicle). The methodology does not take into account the potential impact of downstream congestion on intersection operation, nor does the methodology detect and adjust for the impacts of turn-pocket overflows on through traffic and intersection operation.

LEVEL OF SERVICE (LOS) CRITERIA FOR SIGNALIZED INTERSECTIONS (Reference Highway Capacity Manual 2010)

Level of Service	Control Delay (seconds / vehicle)
A	<10
B	>10 - 20
C	>20 - 35
D	>35 - 55
E	>55 - 80
F	>80

Appendix B
Traffic Count Data

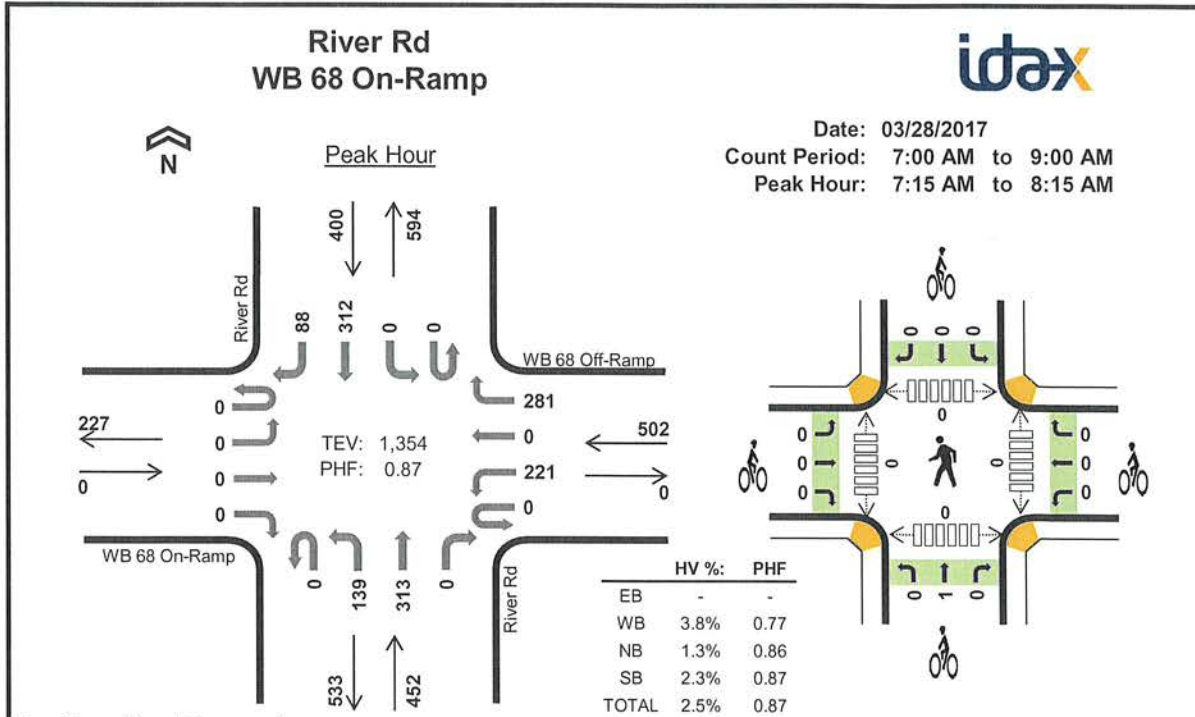

Two-Hour Count Summaries

Interval Start	WB 68 On-Ramp				WB 68 Off-Ramp				River Rd Northbound				River Rd Southbound				15-min Total	Rolling One Hour	
	UT	LT	TH	RT	UT	LT	TH	RT	UT	LT	TH	RT	UT	LT	TH	RT			
7:00 AM	0	0	0	0	0	61	0	67	0	50	55	0	0	0	51	24	308	0	
7:15 AM	0	0	0	0	0	37	0	81	0	46	73	0	0	0	68	21	326	0	
7:30 AM	0	0	0	0	0	34	0	60	0	22	68	0	0	0	77	25	286	0	
7:45 AM	0	0	0	0	0	54	0	72	0	31	80	0	0	0	90	25	352	1,272	
8:00 AM	0	0	0	0	0	96	0	68	0	40	92	0	0	0	77	17	390	1,354	
8:15 AM	0	0	0	0	0	60	0	66	0	24	74	0	0	0	50	19	293	1,321	
8:30 AM	0	0	0	0	0	40	0	56	0	31	57	0	0	0	48	26	258	1,293	
8:45 AM	0	0	0	0	0	43	0	47	0	43	41	0	0	0	63	14	251	1,192	
Count Total	0	0	0	0	0	425	0	517	0	287	540	0	0	0	524	171	2,464	0	
Peak Hour	All	0	0	0	0	0	221	0	281	0	139	313	0	0	0	312	88	1,354	0
	HV%	-	-	-	-	-	6%	-	2%	-	3%	1%	-	-	-	2%	2%	3%	0

Note: Two-hour count summary volumes include heavy vehicles but exclude bicycles in overall count.

Interval Start	Heavy Vehicle Totals					Bicycles					Pedestrians (Crossing Leg)				
	EB	WB	NB	SB	Total	EB	WB	NB	SB	Total	East	West	North	South	Total
7:00 AM	0	3	1	3	7	0	0	0	0	0	0	0	0	0	0
7:15 AM	0	5	0	0	5	0	0	0	0	0	0	0	0	0	0
7:30 AM	0	4	2	3	9	0	0	1	0	1	0	0	0	0	0
7:45 AM	0	5	0	3	8	0	0	0	0	0	0	0	0	0	0
8:00 AM	0	5	4	3	12	0	0	0	0	0	0	0	0	0	0
8:15 AM	0	8	0	2	10	0	0	0	1	1	0	0	0	0	0
8:30 AM	0	4	2	1	7	0	0	0	0	0	0	0	0	0	0
8:45 AM	0	5	1	4	10	0	0	0	0	0	0	0	0	0	0
Count Total	0	39	10	19	68	0	0	1	1	2	0	0	0	0	0
Peak Hour	0	19	6	9	34	0	0	1	0	1	0	0	0	0	0

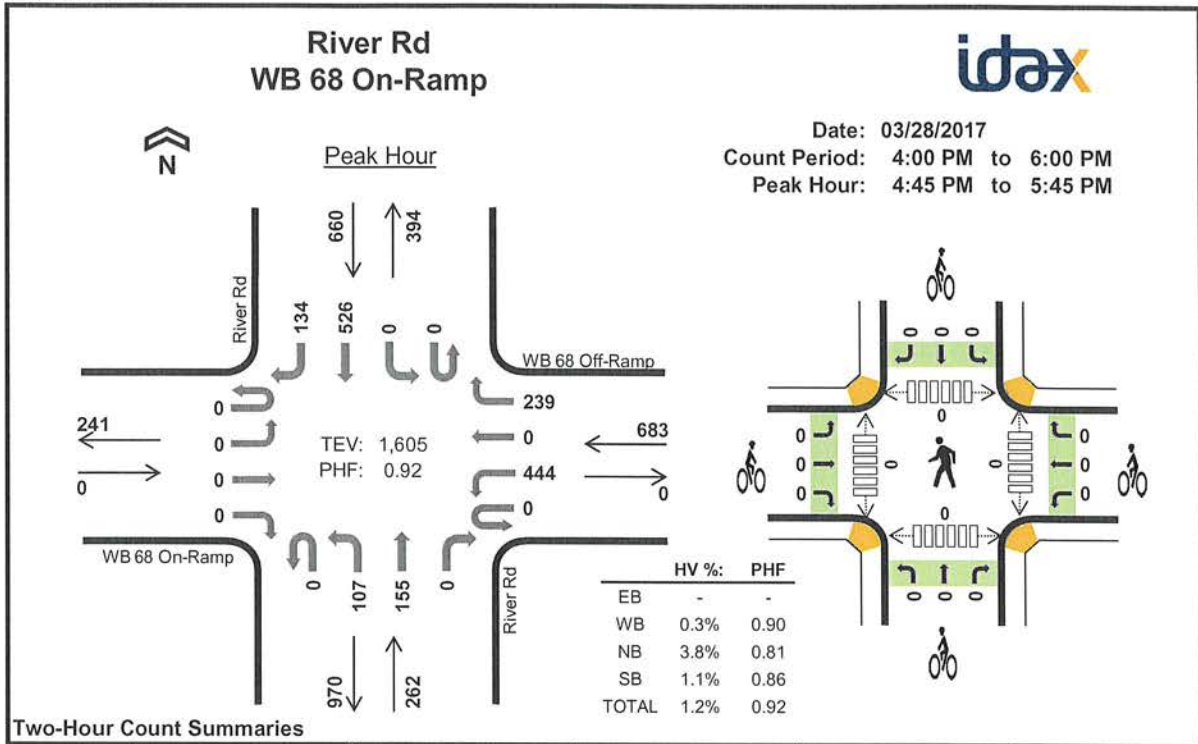

Two-Hour Count Summaries

Interval Start	WB 68 On-Ramp				WB 68 Off-Ramp				River Rd Northbound				River Rd Southbound				15-min Total	Rolling One Hour	
	UT	LT	TH	RT	UT	LT	TH	RT	UT	LT	TH	RT	UT	LT	TH	RT			
4:00 PM	0	0	0	0	0	70	0	38	0	39	26	0	0	0	94	27	294	0	
4:15 PM	0	0	0	0	0	76	0	53	0	29	47	0	0	0	125	37	367	0	
4:30 PM	0	0	0	0	0	78	0	50	0	36	58	0	0	0	97	39	358	0	
4:45 PM	0	0	0	0	0	93	0	48	0	39	42	0	0	0	114	37	373	1,392	
5:00 PM	0	0	0	0	0	108	0	64	0	19	36	0	0	0	125	25	377	1,475	
5:15 PM	0	0	0	0	0	130	0	60	0	16	40	0	0	0	153	38	437	1,545	
5:30 PM	0	0	0	0	0	113	0	67	0	33	37	0	0	0	134	34	418	1,605	
5:45 PM	0	0	0	0	0	99	0	51	0	22	30	0	0	0	127	26	355	1,587	
Count Total	0	0	0	0	0	767	0	431	0	233	316	0	0	0	969	263	2,979	0	
Peak Hour	All	0	0	0	0	0	444	0	239	0	107	155	0	0	0	526	134	1,605	0
	HV	0	0	0	0	0	2	0	0	0	2	8	0	0	0	6	1	19	0
	HV%	-	-	-	-	-	0%	-	0%	-	2%	5%	-	-	-	1%	1%	1%	0

Note: Two-hour count summary volumes include heavy vehicles but exclude bicycles in overall count.

Interval Start	Heavy Vehicle Totals					Bicycles					Pedestrians (Crossing Leg)				
	EB	WB	NB	SB	Total	EB	WB	NB	SB	Total	East	West	North	South	Total
4:00 PM	0	1	3	6	10	0	0	0	1	1	0	2	0	0	2
4:15 PM	0	1	1	3	5	0	0	1	0	1	0	0	0	0	0
4:30 PM	0	1	1	2	4	0	0	0	0	0	0	0	0	0	0
4:45 PM	0	0	7	2	9	0	0	0	0	0	0	0	0	0	0
5:00 PM	0	0	0	1	1	0	0	0	0	0	0	0	0	0	0
5:15 PM	0	1	0	1	2	0	0	0	0	0	0	0	0	0	0
5:30 PM	0	1	3	3	7	0	0	0	0	0	0	0	0	0	0
5:45 PM	0	0	0	2	2	0	0	0	0	0	0	0	0	0	0
Count Total	0	5	15	20	40	0	0	1	1	2	0	2	0	0	2
Peak Hour	0	2	10	7	19	0	0	0	0	0	0	0	0	0	0

River Rd EB 68 Off-Ramp



Date: 03/23/2017
 Count Period: 7:00 AM to 9:00 AM
 Peak Hour: 7:30 AM to 8:30 AM

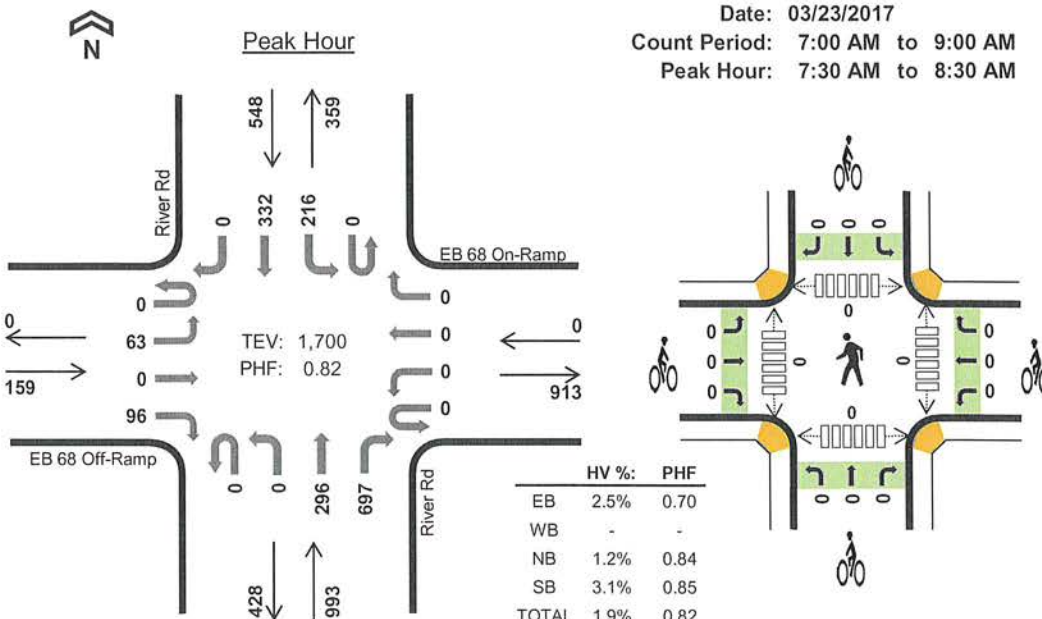

Two-Hour Count Summaries

Interval Start	EB 68 Off-Ramp				EB 68 On-Ramp				River Rd Northbound				River Rd Southbound				15-min Total	Rolling One Hour	
	UT	LT	TH	RT	UT	LT	TH	RT	UT	LT	TH	RT	UT	LT	TH	RT			
7:00 AM	0	19	0	24	0	0	0	0	0	0	103	65	0	28	64	0	303	0	
7:15 AM	0	13	0	25	0	0	0	0	0	0	74	84	0	44	63	0	303	0	
7:30 AM	0	12	0	20	0	0	0	0	0	0	49	158	0	70	60	0	369	0	
7:45 AM	0	12	0	18	0	0	0	0	0	0	60	176	0	65	75	0	406	1,381	
8:00 AM	0	23	0	34	0	0	0	0	0	0	106	191	0	46	116	0	516	1,594	
8:15 AM	0	16	0	24	0	0	0	0	0	0	81	172	0	35	81	0	409	1,700	
8:30 AM	0	16	0	16	0	0	0	0	0	0	73	75	0	35	61	0	276	1,607	
8:45 AM	0	22	0	23	0	0	0	0	0	0	61	63	0	24	53	0	246	1,447	
Count Total	0	133	0	184	0	0	0	0	0	0	607	984	0	347	573	0	2,828	0	
Peak Hour	All	0	63	0	96	0	0	0	0	0	0	296	697	0	216	332	0	1,700	0
	HV	0	1	0	3	0	0	0	0	0	0	5	7	0	7	10	0	33	0
	HV%	-	2%	-	3%	-	-	-	-	-	-	2%	1%	-	3%	3%	-	2%	0

Note: Two-hour count summary volumes include heavy vehicles but exclude bicycles in overall count.

Interval Start	Heavy Vehicle Totals					Bicycles					Pedestrians (Crossing Leg)					
	EB	WB	NB	SB	Total	EB	WB	NB	SB	Total	East	West	North	South	Total	
7:00 AM	1	0	1	6	8	0	0	0	0	0	0	0	0	0	0	0
7:15 AM	0	0	1	4	5	0	0	0	0	0	0	0	0	0	0	0
7:30 AM	2	0	1	4	7	0	0	0	0	0	0	0	0	0	0	0
7:45 AM	0	0	1	8	9	0	0	0	0	0	0	0	0	0	0	0
8:00 AM	2	0	3	2	7	0	0	0	0	0	0	0	0	0	0	0
8:15 AM	0	0	7	3	10	0	0	0	0	0	0	0	0	0	0	0
8:30 AM	0	0	1	7	8	0	0	0	0	0	0	0	0	0	0	0
8:45 AM	2	0	1	3	6	0	0	0	0	0	0	0	0	0	0	0
Count Total	7	0	16	37	60	0	0	0	0	0	0	0	0	0	0	0
Peak Hour	4	0	12	17	33	0	0	0	0	0	0	0	0	0	0	0

River Rd EB 68 Off-Ramp



Date: 03/23/2017
Count Period: 4:00 PM to 6:00 PM
Peak Hour: 4:30 PM to 5:30 PM

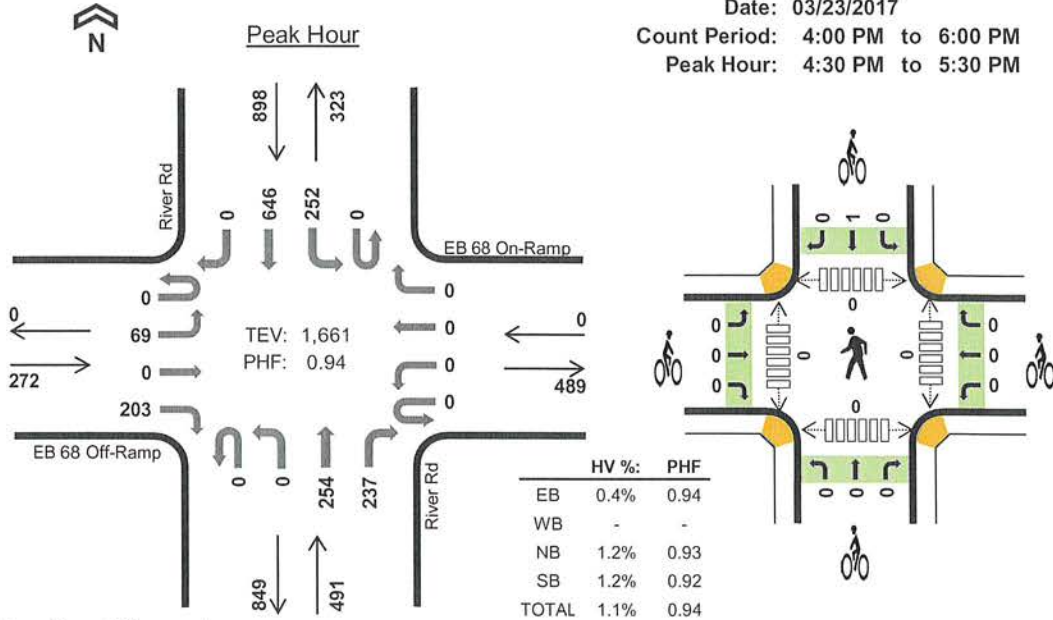

Two-Hour Count Summaries

Interval Start	EB 68 Off-Ramp				EB 68 On-Ramp				River Rd				River Rd				15-min Total	Rolling One Hour	
	Eastbound				Westbound				Northbound				Southbound						
	UT	LT	TH	RT	UT	LT	TH	RT	UT	LT	TH	RT	UT	LT	TH	RT			
4:00 PM	0	20	0	58	0	0	0	0	0	0	50	66	0	53	125	0	372	0	
4:15 PM	0	19	0	38	0	0	0	0	0	0	54	66	0	54	138	0	369	0	
4:30 PM	0	20	0	45	0	0	0	0	0	0	76	53	0	58	164	0	416	0	
4:45 PM	0	20	0	47	0	0	0	0	0	0	59	73	0	59	137	0	395	1,552	
5:00 PM	0	18	0	54	0	0	0	0	0	0	61	66	0	66	177	0	442	1,622	
5:15 PM	0	11	0	57	0	0	0	0	0	0	58	45	0	69	168	0	408	1,661	
5:30 PM	0	14	0	51	0	0	0	0	0	0	53	77	0	58	157	0	410	1,655	
5:45 PM	0	14	0	58	0	0	0	0	0	0	33	65	0	48	144	0	362	1,622	
Count Total	0	136	0	408	0	0	0	0	0	0	444	511	0	465	1,210	0	3,174	0	
Peak Hour	All	0	69	0	203	0	0	0	0	0	0	254	237	0	252	646	0	1,661	0
	HV	0	0	0	1	0	0	0	0	0	0	3	3	0	5	6	0	18	0
	HV%	-	0%	-	0%	-	-	-	-	-	-	1%	1%	-	2%	1%	-	1%	0

Note: Two-hour count summary volumes include heavy vehicles but exclude bicycles in overall count.

Interval Start	Heavy Vehicle Totals					Bicycles					Pedestrians (Crossing Leg)				
	EB	WB	NB	SB	Total	EB	WB	NB	SB	Total	East	West	North	South	Total
4:00 PM	1	0	0	3	4	0	0	0	0	0	0	0	0	0	0
4:15 PM	1	0	1	4	6	0	0	0	0	0	0	0	0	0	0
4:30 PM	0	0	0	3	3	0	0	0	0	0	0	0	0	0	0
4:45 PM	1	0	5	1	7	0	0	0	0	0	0	0	0	0	0
5:00 PM	0	0	1	3	4	0	0	0	1	1	0	0	0	0	0
5:15 PM	0	0	0	4	4	0	0	0	0	0	0	0	0	0	0
5:30 PM	0	0	0	5	5	0	0	0	0	0	0	0	0	0	0
5:45 PM	2	0	0	1	3	0	0	0	0	0	0	0	0	0	0
Count Total	5	0	7	24	36	0	0	0	1	1	0	0	0	0	0
Peak Hour	1	0	6	11	18	0	0	0	1	1	0	0	0	0	0

Las Palmas Rd River Rd



Peak Hour

Date: 05/18/2017
Count Period: 7:00 AM to 9:00 AM
Peak Hour: 7:30 AM to 8:30 AM

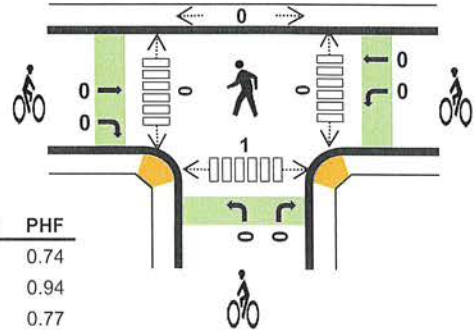
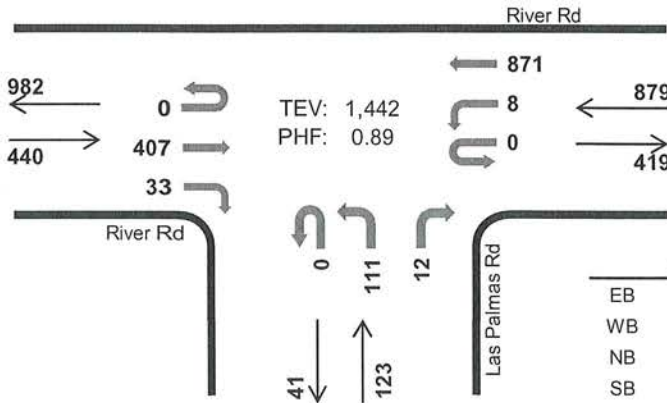

	HV %:	PHF
EB	6.1%	0.74
WB	2.2%	0.94
NB	0.0%	0.77
SB	-	-
TOTAL	3.2%	0.89

Two-Hour Count Summaries

Interval Start	River Rd Eastbound				River Rd Westbound				Las Palmas Rd Northbound				0 Southbound				15-min Total	Rolling One Hour	
	UT	LT	TH	RT	UT	LT	TH	RT	UT	LT	TH	RT	UT	LT	TH	RT			
7:00 AM	0	0	68	1	0	0	172	0	0	25	0	2	0	0	0	0	268	0	
7:15 AM	0	0	68	6	0	0	151	0	0	38	0	1	0	0	0	0	264	0	
7:30 AM	0	0	86	4	0	3	228	0	0	31	0	3	0	0	0	0	355	0	
7:45 AM	0	0	101	11	0	1	197	0	0	35	0	5	0	0	0	0	350	1,237	
8:00 AM	0	0	141	8	0	3	232	0	0	19	0	4	0	0	0	0	407	1,376	
8:15 AM	0	0	79	10	0	1	214	0	0	26	0	0	0	0	0	0	330	1,442	
8:30 AM	0	0	87	7	0	1	118	0	0	18	0	0	0	0	0	0	231	1,318	
8:45 AM	0	0	66	6	0	1	118	0	0	21	0	0	0	0	0	0	212	1,180	
Count Total	0	0	696	53	0	10	1,430	0	0	213	0	15	0	0	0	0	2,417	0	
Peak Hour	All	0	0	407	33	0	8	871	0	0	111	0	12	0	0	0	0	1,442	0
	HV	0	0	25	2	0	0	19	0	0	0	0	0	0	0	0	0	46	0
	HV%	-	-	6%	6%	-	0%	2%	-	-	0%	-	0%	-	-	-	-	3%	0

Note: Two-hour count summary volumes include heavy vehicles but exclude bicycles in overall count.

Interval Start	Heavy Vehicle Totals					Bicycles					Pedestrians (Crossing Leg)				
	EB	WB	NB	SB	Total	EB	WB	NB	SB	Total	East	West	North	South	Total
7:00 AM	1	0	0	0	1	0	0	0	0	0	0	0	0	0	0
7:15 AM	2	3	0	0	5	0	0	0	0	0	0	0	0	0	0
7:30 AM	10	2	0	0	12	0	0	0	0	0	0	0	0	0	0
7:45 AM	4	6	0	0	10	0	0	0	0	0	0	0	0	0	0
8:00 AM	9	4	0	0	13	0	0	0	0	0	0	0	0	1	1
8:15 AM	4	7	0	0	11	0	0	0	0	0	0	0	0	0	0
8:30 AM	4	2	0	0	6	0	0	0	0	0	0	0	0	0	0
8:45 AM	3	3	1	0	7	0	0	0	0	0	0	0	0	0	0
Count Total	37	27	1	0	65	0	0	0	0	0	0	0	0	1	1
Peak Hr	27	19	0	0	46	0	0	0	0	0	0	0	0	1	1

Las Palmas Rd River Rd



Peak Hour

Date: 05/18/2017
Count Period: 4:00 PM to 6:00 PM
Peak Hour: 4:15 PM to 5:15 PM

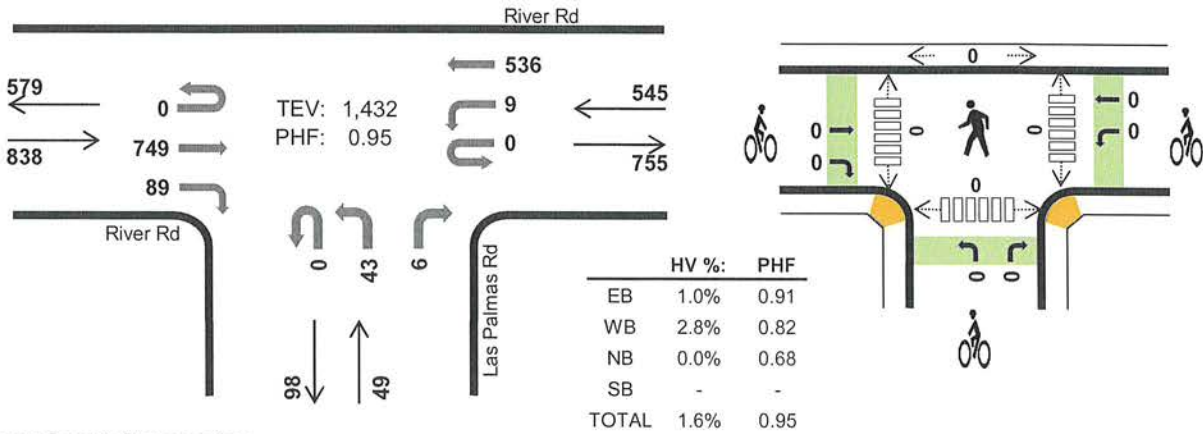

Two-Hour Count Summaries

Interval Start	River Rd Eastbound				River Rd Westbound				Las Palmas Rd Northbound				0 Southbound				15-min Total	Rolling One Hour	
	UT	LT	TH	RT	UT	LT	TH	RT	UT	LT	TH	RT	UT	LT	TH	RT			
4:00 PM	0	0	157	18	0	4	106	0	0	6	0	2	0	0	0	0	293	0	
4:15 PM	0	0	208	22	0	2	131	0	0	9	0	3	0	0	0	0	375	0	
4:30 PM	0	0	172	20	0	4	162	0	0	17	0	1	0	0	0	0	376	0	
4:45 PM	0	0	170	24	0	0	117	0	0	9	0	2	0	0	0	0	322	1,366	
5:00 PM	0	0	199	23	0	3	126	0	0	8	0	0	0	0	0	0	359	1,432	
5:15 PM	0	0	207	29	0	2	110	0	0	18	0	3	0	0	0	0	369	1,426	
5:30 PM	0	0	172	13	0	1	127	0	0	16	0	2	0	0	0	0	331	1,381	
5:45 PM	0	0	170	28	0	1	94	0	0	7	0	2	0	0	0	0	302	1,361	
Count Total	0	0	1,455	177	0	17	973	0	0	90	0	15	0	0	0	0	2,727	0	
Peak Hour	All	0	0	749	89	0	9	536	0	0	43	0	6	0	0	0	0	1,432	0
	HV	0	0	7	1	0	0	15	0	0	0	0	0	0	0	0	0	23	0
	HV%	-	-	1%	1%	-	0%	3%	-	-	0%	-	0%	-	-	-	-	2%	0

















Note: Two-hour count summary volumes include heavy vehicles but exclude bicycles in overall count.

Interval Start	Heavy Vehicle Totals					Bicycles					Pedestrians (Crossing Leg)				
	EB	WB	NB	SB	Total	EB	WB	NB	SB	Total	East	West	North	South	Total
4:00 PM	5	2	2	0	9	0	0	0	0	0	0	0	0	0	0
4:15 PM	2	2	0	0	4	0	0	0	0	0	0	0	0	0	0
4:30 PM	0	2	0	0	2	0	0	0	0	0	0	0	0	0	0
4:45 PM	3	7	0	0	10	0	0	0	0	0	0	0	0	0	0
5:00 PM	3	4	0	0	7	0	0	0	0	0	0	0	0	0	0
5:15 PM	3	3	0	0	6	0	0	0	0	0	0	0	0	0	0
5:30 PM	1	3	0	0	4	0	0	1	0	1	0	0	0	0	0
5:45 PM	0	3	0	0	3	0	0	0	0	0	0	0	0	0	0
Count Total	17	26	2	0	45	0	0	1	0	1	0	0	0	0	0
Peak Hr	8	15	0	0	23	0	0	0	0	0	0	0	0	0	0

Appendix C
Level of Service Calculation Worksheets



















HCM 2010 Signalized Intersection Summary
 1: Hwy 68 WB Ramps & Reservation Rd.

Existing AM.syn
 05/31/2017

												
Movement	EBL	EBT	EBR	WBL	WBT	WBR	NBL	NBT	NBR	SBL	SBT	SBR
Lane Configurations												
Traffic Volume (veh/h)	0	0	0	221	0	281	136	313	0	0	329	88
Future Volume (veh/h)	0	0	0	221	0	281	136	313	0	0	329	88
Number				7	4	14	1	6	16	5	2	12
Initial Q (Qb), veh				0	0	0	0	0	0	0	0	0
Ped-Bike Adj(A_pbT)				1.00		0.98	1.00		1.00	1.00		1.00
Parking Bus, Adj				1.00	1.00	1.00	1.00	1.00	1.00	1.00	1.00	1.00
Adj Sat Flow, veh/h/ln				1900	1792	1863	1845	1881	0	0	1863	1900
Adj Flow Rate, veh/h				254	0	323	156	360	0	0	378	101
Adj No. of Lanes				0	1	1	1	1	0	0	1	0
Peak Hour Factor				0.87	0.87	0.87	0.87	0.87	0.87	0.87	0.87	0.87
Percent Heavy Veh, %				2	0	2	3	1	0	0	2	2
Cap, veh/h				541	0	491	189	1035	0	0	533	142
Arrive On Green				0.32	0.00	0.32	0.11	0.55	0.00	0.00	0.38	0.34
Sat Flow, veh/h				1707	0	1550	1757	1881	0	0	1417	379
Grp Volume(v), veh/h				254	0	323	156	360	0	0	0	479
Grp Sat Flow(s),veh/h/ln				1707	0	1550	1757	1881	0	0	0	1796
Q Serve(g_s), s				7.2	0.0	10.8	5.2	6.4	0.0	0.0	0.0	13.7
Cycle Q Clear(g_c), s				7.2	0.0	10.8	5.2	6.4	0.0	0.0	0.0	13.7
Prop In Lane				1.00		1.00	1.00		0.00	0.00		0.21
Lane Grp Cap(c), veh/h				541	0	491	189	1035	0	0	0	675
V/C Ratio(X)				0.47	0.00	0.66	0.83	0.35	0.00	0.00	0.00	0.71
Avail Cap(c_a), veh/h				541	0	491	246	1035	0	0	0	675
HCM Platoon Ratio				1.00	1.00	1.00	1.00	1.00	1.00	1.00	1.00	1.00
Upstream Filter(I)				1.00	0.00	1.00	1.00	1.00	0.00	0.00	0.00	1.00
Uniform Delay (d), s/veh				16.5	0.0	17.7	26.2	7.5	0.0	0.0	0.0	16.1
Incr Delay (d2), s/veh				2.9	0.0	6.8	16.1	0.9	0.0	0.0	0.0	3.5
Initial Q Delay(d3),s/veh				0.0	0.0	0.0	0.0	0.0	0.0	0.0	0.0	0.0
%ile BackOfQ(50%),veh/ln				3.8	0.0	5.5	3.4	3.6	0.0	0.0	0.0	7.3
LnGrp Delay(d),s/veh				19.4	0.0	24.5	42.3	8.4	0.0	0.0	0.0	19.6
LnGrp LOS				B		C	D	A				B
Approach Vol, veh/h					577			516			479	
Approach Delay, s/veh					22.2			18.7			19.6	
Approach LOS					C			B			B	
Timer	1	2	3	4	5	6	7	8				
Assigned Phs	1	2		4		6						
Phs Duration (G+Y+Rc), s		26.6		23.0		37.0						
Change Period (Y+Rc), s	3.7	6.0		4.9		6.0						
Max Green Setting (Gmax), s	18.6			18.1		31.0						
Max Q Clear Time (g_c+1), s	15.7			12.8		8.4						
Green Ext Time (p_c), s	0.1	1.0		1.2		3.2						
Intersection Summary												
HCM 2010 Ctrl Delay				20.3								
HCM 2010 LOS				C								

HCM 2010 Signalized Intersection Summary
 2: River Rd. & Hwy 68 EB Ramps

Existing AM.syn
 05/31/2017

												
Movement	EBL	EBT	EBR	WBL	WBT	WBR	NBL	NBT	NBR	SBL	SBT	SBR
Lane Configurations												
Traffic Volume (veh/h)	113	0	96	0	0	0	0	336	697	216	334	0
Future Volume (veh/h)	113	0	96	0	0	0	0	336	697	216	334	0
Number	3	8	18				1	6	16	5	2	12
Initial Q (Qb), veh	0	0	0				0	0	0	0	0	0
Ped-Bike Adj(A_pbT)	1.00		1.00				1.00		1.00	1.00		1.00
Parking Bus, Adj	1.00	1.00	1.00				1.00	1.00	1.00	1.00	1.00	1.00
Adj Sat Flow, veh/h/ln	1900	1900	1845				0	1863	1881	1845	1845	0
Adj Flow Rate, veh/h	138	0	117				0	410	850	263	407	0
Adj No. of Lanes	0	1	1				0	1	1	1	1	0
Peak Hour Factor	0.82	0.82	0.82				0.82	0.82	0.82	0.82	0.82	0.82
Percent Heavy Veh, %	3	2	3				0	2	1	3	3	0
Cap, veh/h	198	0	172				0	1126	966	290	1493	0
Arrive On Green	0.11	0.00	0.11				0.00	0.60	0.60	0.16	0.81	0.00
Sat Flow, veh/h	1810	0	1568				0	1863	1599	1757	1845	0
Grp Volume(v), veh/h	138	0	117				0	410	850	263	407	0
Grp Sat Flow(s),veh/h/ln	1810	0	1568				0	1863	1599	1757	1845	0
Q Serve(g_s), s	7.3	0.0	7.1				0.0	11.0	44.4	14.5	5.3	0.0
Cycle Q Clear(g_c), s	7.3	0.0	7.1				0.0	11.0	44.4	14.5	5.3	0.0
Prop In Lane	1.00		1.00				0.00		1.00	1.00		0.00
Lane Grp Cap(c), veh/h	198	0	172				0	1126	966	290	1493	0
V/C Ratio(X)	0.70	0.00	0.68				0.00	0.36	0.88	0.91	0.27	0.00
Avail Cap(c_a), veh/h	401	0	347				0	1126	966	302	1493	0
HCM Platoon Ratio	1.00	1.00	1.00				1.00	1.00	1.00	1.00	1.00	1.00
Upstream Filter(I)	1.00	0.00	1.00				0.00	1.00	1.00	1.00	1.00	0.00
Uniform Delay (d), s/veh	42.5	0.0	42.4				0.0	9.9	16.5	40.6	2.3	0.0
Incr Delay (d2), s/veh	4.4	0.0	4.7				0.0	0.2	9.4	28.9	0.5	0.0
Initial Q Delay(d3),s/veh	0.0	0.0	0.0				0.0	0.0	0.0	0.0	0.0	0.0
%ile BackOfQ(50%),veh/ln	3.9	0.0	3.3				0.0	5.6	21.9	9.4	2.8	0.0
LnGrp Delay(d),s/veh	46.8	0.0	47.1				0.0	10.1	25.9	69.5	2.8	0.0
LnGrp LOS	D		D					B	C	E	A	
Approach Vol, veh/h		255						1260			670	
Approach Delay, s/veh		46.9						20.8			28.9	
Approach LOS		D						C			C	
Timer	1	2	3	4	5	6	7	8				
Assigned Phs		2			5	6		8				
Phs Duration (G+Y+Rc), s		84.1			20.3	63.8		14.8				
Change Period (Y+Rc), s		6.0			3.7	6.0		4.9				
Max Green Setting (Gmax), s		78.1			17.3	57.1		21.0				
Max Q Clear Time (g_c+I1), s		7.3			16.5	46.4		9.3				
Green Ext Time (p_c), s		9.9			0.1	5.6		0.7				
Intersection Summary												
HCM 2010 Ctrl Delay			26.3									
HCM 2010 LOS			C									

















HCM 2010 Signalized Intersection Summary
 3: Las Palmas Rd & River Rd.

Existing AM.syn
 05/31/2017

	→	↘	↙	←	↖	↗		
Movement	EBT	EBR	WBL	WBT	NBL	NBR		
Lane Configurations	↑↑	↑	↓	↑↑	↓	↑		
Traffic Volume (veh/h)	407	33	8	921	111	12		
Future Volume (veh/h)	407	33	8	921	111	12		
Number	2	12	1	6	3	18		
Initial Q (Qb), veh	0	0	0	0	0	0		
Ped-Bike Adj(A_pbT)		1.00	1.00		1.00	1.00		
Parking Bus, Adj	1.00	1.00	1.00	1.00	1.00	1.00		
Adj Sat Flow, veh/h/ln	1792	1792	1900	1863	1900	1900		
Adj Flow Rate, veh/h	457	37	9	1035	125	13		
Adj No. of Lanes	2	1	1	2	1	1		
Peak Hour Factor	0.89	0.89	0.89	0.89	0.89	0.89		
Percent Heavy Veh, %	6	6	0	2	0	0		
Cap, veh/h	1486	664	18	2118	175	156		
Arrive On Green	0.44	0.44	0.01	0.60	0.10	0.10		
Sat Flow, veh/h	3495	1522	1810	3632	1810	1615		
Grp Volume(v), veh/h	457	37	9	1035	125	13		
Grp Sat Flow(s),veh/h/ln	1703	1522	1810	1770	1810	1615		
Q Serve(g_s), s	2.3	0.4	0.1	4.4	1.8	0.2		
Cycle Q Clear(g_c), s	2.3	0.4	0.1	4.4	1.8	0.2		
Prop In Lane		1.00	1.00		1.00	1.00		
Lane Grp Cap(c), veh/h	1486	664	18	2118	175	156		
V/C Ratio(X)	0.31	0.06	0.51	0.49	0.71	0.08		
Avail Cap(c_a), veh/h	2206	986	276	3372	483	431		
HCM Platoon Ratio	1.00	1.00	1.00	1.00	1.00	1.00		
Upstream Filter(I)	1.00	1.00	1.00	1.00	1.00	1.00		
Uniform Delay (d), s/veh	4.8	4.3	12.9	3.0	11.5	10.8		
Incr Delay (d2), s/veh	0.1	0.0	21.4	0.2	5.3	0.2		
Initial Q Delay(d3),s/veh	0.0	0.0	0.0	0.0	0.0	0.0		
%ile BackOfQ(50%),veh/ln	1.0	0.2	0.2	2.1	1.1	0.1		
LnGrp Delay(d),s/veh	4.9	4.3	34.3	3.2	16.8	11.0		
LnGrp LOS	A	A	C	A	B	B		
Approach Vol, veh/h	494			1044	138			
Approach Delay, s/veh	4.9			3.4	16.3			
Approach LOS	A			A	B			
Timer	1	2	3	4	5	6	7	8
Assigned Phs	1	2				6		8
Phs Duration (G+Y+Rc), s	4.3	15.5				19.7		6.5
Change Period (Y+Rc), s	4.0	4.0				4.0		4.0
Max Green Setting (Gmax)	4.0	17.0				25.0		7.0
Max Q Clear Time (g_c+1)	2.4	4.3				6.4		3.8
Green Ext Time (p_c), s	0.0	7.1				9.0		0.1
Intersection Summary								
HCM 2010 Ctrl Delay			4.9					
HCM 2010 LOS			A					



















HCM 2010 Signalized Intersection Summary
 1: Hwy 68 WB Ramps & Reservation Rd.

Existing PM.syn
 05/31/2017

												
Movement	EBL	EBT	EBR	WBL	WBT	WBR	NBL	NBT	NBR	SBL	SBT	SBR
Lane Configurations												
Traffic Volume (veh/h)	0	0	0	444	0	239	107	216	0	0	526	134
Future Volume (veh/h)	0	0	0	444	0	239	107	216	0	0	526	134
Number				7	4	14	1	6	16	5	2	12
Initial Q (Qb), veh				0	0	0	0	0	0	0	0	0
Ped-Bike Adj(A_pbT)				1.00		1.00	1.00		1.00	1.00		1.00
Parking Bus, Adj				1.00	1.00	1.00	1.00	1.00	1.00	1.00	1.00	1.00
Adj Sat Flow, veh/h/ln				1900	1900	1900	1863	1810	0	0	1881	1900
Adj Flow Rate, veh/h				483	0	260	116	235	0	0	572	146
Adj No. of Lanes				0	1	1	1	1	0	0	1	0
Peak Hour Factor				0.92	0.92	0.92	0.92	0.92	0.92	0.92	0.92	0.92
Percent Heavy Veh, %				0	0	0	2	5	0	0	1	1
Cap, veh/h				555	0	495	140	1062	0	0	657	168
Arrive On Green				0.31	0.00	0.31	0.08	0.59	0.00	0.00	0.45	0.43
Sat Flow, veh/h				1810	0	1615	1774	1810	0	0	1447	369
Grp Volume(v), veh/h				483	0	260	116	235	0	0	0	718
Grp Sat Flow(s),veh/h/ln				1810	0	1615	1774	1810	0	0	0	1816
Q Serve(g_s), s				18.9	0.0	10.0	4.8	4.6	0.0	0.0	0.0	26.8
Cycle Q Clear(g_c), s				18.9	0.0	10.0	4.8	4.6	0.0	0.0	0.0	26.8
Prop In Lane				1.00		1.00	1.00		0.00	0.00		0.20
Lane Grp Cap(c), veh/h				555	0	495	140	1062	0	0	0	825
V/C Ratio(X)				0.87	0.00	0.52	0.83	0.22	0.00	0.00	0.00	0.87
Avail Cap(c_a), veh/h				555	0	495	142	1062	0	0	0	825
HCM Platoon Ratio				1.00	1.00	1.00	1.00	1.00	1.00	1.00	1.00	1.00
Upstream Filter(I)				1.00	0.00	1.00	1.00	1.00	0.00	0.00	0.00	1.00
Uniform Delay (d), s/veh				24.6	0.0	21.5	34.0	7.4	0.0	0.0	0.0	18.7
Incr Delay (d2), s/veh				16.9	0.0	3.9	31.4	0.5	0.0	0.0	0.0	10.0
Initial Q Delay(d3),s/veh				0.0	0.0	0.0	0.0	0.0	0.0	0.0	0.0	0.0
%ile BackOfQ(50%),veh/ln				12.0	0.0	4.9	3.6	2.4	0.0	0.0	0.0	15.7
LnGrp Delay(d),s/veh				41.5	0.0	25.4	65.4	7.8	0.0	0.0	0.0	28.6
LnGrp LOS				D		C	E	A				C
Approach Vol, veh/h					743			351			718	
Approach Delay, s/veh					35.9			26.9			28.6	
Approach LOS					D			C			C	
Timer	1	2	3	4	5	6	7	8				
Assigned Phs	1	2		4		6						
Phs Duration (G+Y+Rc), s	9.9	38.1		27.0		48.0						
Change Period (Y+Rc), s	3.7	6.0		4.9		6.0						
Max Green Setting (Gmax) s	32.0			22.1		42.0						
Max Q Clear Time (g_c+1) s	32.8			20.9		6.6						
Green Ext Time (p_c), s	0.0	1.3		0.4		4.2						
Intersection Summary												
HCM 2010 Ctrl Delay				31.3								
HCM 2010 LOS				C								







HCM 2010 Signalized Intersection Summary
 2: River Rd. & Hwy 68 EB Ramps

Existing PM.syn
 05/31/2017

												
Movement	EBL	EBT	EBR	WBL	WBT	WBR	NBL	NBT	NBR	SBL	SBT	SBR
Lane Configurations												
Traffic Volume (veh/h)	69	0	203	0	0	0	0	254	325	252	718	0
Future Volume (veh/h)	69	0	203	0	0	0	0	254	325	252	718	0
Number	3	8	18				1	6	16	5	2	12
Initial Q (Qb), veh	0	0	0				0	0	0	0	0	0
Ped-Bike Adj(A_pbT)	1.00		1.00				1.00		1.00	1.00		1.00
Parking Bus, Adj	1.00	1.00	1.00				1.00	1.00	1.00	1.00	1.00	1.00
Adj Sat Flow, veh/h/ln	1900	1900	1900				0	1881	1881	1863	1900	0
Adj Flow Rate, veh/h	73	0	216				0	270	346	268	764	0
Adj No. of Lanes	0	1	1				0	1	1	1	1	0
Peak Hour Factor	0.94	0.94	0.94				0.94	0.94	0.94	0.94	0.94	0.94
Percent Heavy Veh, %	0	0	0				0	1	1	2	0	0
Cap, veh/h	348	0	311				0	758	644	319	1250	0
Arrive On Green	0.19	0.00	0.19				0.00	0.40	0.40	0.18	0.66	0.00
Sat Flow, veh/h	1810	0	1615				0	1881	1599	1774	1900	0
Grp Volume(v), veh/h	73	0	216				0	270	346	268	764	0
Grp Sat Flow(s),veh/h/ln	1810	0	1615				0	1881	1599	1774	1900	0
Q Serve(g_s), s	1.8	0.0	6.7				0.0	5.3	8.8	7.8	12.3	0.0
Cycle Q Clear(g_c), s	1.8	0.0	6.7				0.0	5.3	8.8	7.8	12.3	0.0
Prop In Lane	1.00		1.00				0.00		1.00	1.00		0.00
Lane Grp Cap(c), veh/h	348	0	311				0	758	644	319	1250	0
V/C Ratio(X)	0.21	0.00	0.70				0.00	0.36	0.54	0.84	0.61	0.00
Avail Cap(c_a), veh/h	743	0	663				0	758	644	432	1250	0
HCM Platoon Ratio	1.00	1.00	1.00				1.00	1.00	1.00	1.00	1.00	1.00
Upstream Filter(I)	1.00	0.00	1.00				0.00	1.00	1.00	1.00	1.00	0.00
Uniform Delay (d), s/veh	18.1	0.0	20.1				0.0	11.1	12.1	21.1	5.2	0.0
Incr Delay (d2), s/veh	0.3	0.0	2.8				0.0	0.3	0.9	10.4	2.2	0.0
Initial Q Delay(d3),s/veh	0.0	0.0	0.0				0.0	0.0	0.0	0.0	0.0	0.0
%ile BackOfQ(50%),veh/ln	0.9	0.0	3.2				0.0	2.8	4.0	4.7	6.9	0.0
LnGrp Delay(d),s/veh	18.4	0.0	22.9				0.0	11.4	13.0	31.5	7.5	0.0
LnGrp LOS	B		C					B	B	C	A	
Approach Vol, veh/h		289						616			1032	
Approach Delay, s/veh		21.8						12.3			13.7	
Approach LOS		C						B			B	
Timer	1	2	3	4	5	6	7	8				
Assigned Phs		2			5	6		8				
Phs Duration (G+Y+Rc), s		39.1			13.6	25.5		14.3				
Change Period (Y+Rc), s		6.0			3.7	6.0		4.9				
Max Green Setting (Gmax), s		33.1			13.3	16.1		21.0				
Max Q Clear Time (g_c+I1), s		14.3			9.8	10.8		8.7				
Green Ext Time (p_c), s		5.7			0.3	2.8		0.8				
Intersection Summary												
HCM 2010 Ctrl Delay			14.5									
HCM 2010 LOS			B									

















HCM 2010 Signalized Intersection Summary
 3: Las Palmas Rd & River Rd.

Existing PM.syn
 05/31/2017

								
Movement	EBT	EBR	WBL	WBT	NBL	NBR		
Lane Configurations	↑↑	↑	↓	↑↑	↓	↑		
Traffic Volume (veh/h)	816	97	9	536	43	6		
Future Volume (veh/h)	816	97	9	536	43	6		
Number	2	12	1	6	3	18		
Initial Q (Qb), veh	0	0	0	0	0	0		
Ped-Bike Adj(A_pbT)		1.00	1.00		1.00	1.00		
Parking Bus, Adj	1.00	1.00	1.00	1.00	1.00	1.00		
Adj Sat Flow, veh/h/ln	1881	1881	1900	1845	1900	1900		
Adj Flow Rate, veh/h	859	102	9	564	45	6		
Adj No. of Lanes	2	1	1	2	1	1		
Peak Hour Factor	0.95	0.95	0.95	0.95	0.95	0.95		
Percent Heavy Veh, %	1	1	0	3	0	0		
Cap, veh/h	1766	790	18	2290	85	76		
Arrive On Green	0.49	0.49	0.01	0.65	0.05	0.05		
Sat Flow, veh/h	3668	1599	1810	3597	1810	1615		
Grp Volume(v), veh/h	859	102	9	564	45	6		
Grp Sat Flow(s),veh/h/ln	1787	1599	1810	1752	1810	1615		
Q Serve(g_s), s	4.3	0.9	0.1	1.8	0.6	0.1		
Cycle Q Clear(g_c), s	4.3	0.9	0.1	1.8	0.6	0.1		
Prop In Lane		1.00	1.00		1.00	1.00		
Lane Grp Cap(c), veh/h	1766	790	18	2290	85	76		
V/C Ratio(X)	0.49	0.13	0.51	0.25	0.53	0.08		
Avail Cap(c_a), veh/h	2541	1137	271	3541	339	302		
HCM Platoon Ratio	1.00	1.00	1.00	1.00	1.00	1.00		
Upstream Filter(I)	1.00	1.00	1.00	1.00	1.00	1.00		
Uniform Delay (d), s/veh	4.5	3.7	13.2	1.9	12.4	12.2		
Incr Delay (d2), s/veh	0.2	0.1	21.4	0.1	5.0	0.4		
Initial Q Delay(d3),s/veh	0.0	0.0	0.0	0.0	0.0	0.0		
%ile BackOfQ(50%),veh/ln	2.1	0.4	0.2	0.8	0.4	0.1		
LnGrp Delay(d),s/veh	4.7	3.7	34.6	2.0	17.4	12.6		
LnGrp LOS	A	A	C	A	B	B		
Approach Vol, veh/h	961			573	51			
Approach Delay, s/veh	4.6			2.5	16.8			
Approach LOS	A			A	B			
Timer	1	2	3	4	5	6	7	8
Assigned Phs	1	2				6		8
Phs Duration (G+Y+Rc), s	4.3	17.2				21.5		5.3
Change Period (Y+Rc), s	4.0	4.0				4.0		4.0
Max Green Setting (Gmax)	4.0	19.0				27.0		5.0
Max Q Clear Time (g_c+1)	2.4	6.3				3.8		2.6
Green Ext Time (p_c), s	0.0	6.9				9.6		0.0
Intersection Summary								
HCM 2010 Ctrl Delay			4.2					
HCM 2010 LOS			A					



















HCM 2010 Signalized Intersection Summary
 1: Hwy 68 WB Ramps & Reservation Rd.

Existing + Project AM.syn
 01/17/2022

												
Movement	EBL	EBT	EBR	WBL	WBT	WBR	NBL	NBT	NBR	SBL	SBT	SBR
Lane Configurations												
Traffic Volume (veh/h)	0	0	0	225	0	281	138	317	0	0	331	88
Future Volume (veh/h)	0	0	0	225	0	281	138	317	0	0	331	88
Number				7	4	14	1	6	16	5	2	12
Initial Q (Qb), veh				0	0	0	0	0	0	0	0	0
Ped-Bike Adj(A_pbT)				1.00		0.98	1.00		1.00	1.00		1.00
Parking Bus, Adj				1.00	1.00	1.00	1.00	1.00	1.00	1.00	1.00	1.00
Adj Sat Flow, veh/h/ln				1900	1792	1863	1845	1881	0	0	1863	1900
Adj Flow Rate, veh/h				259	0	323	159	364	0	0	380	101
Adj No. of Lanes				0	1	1	1	1	0	0	1	0
Peak Hour Factor				0.87	0.87	0.87	0.87	0.87	0.87	0.87	0.87	0.87
Percent Heavy Veh, %				6	0	2	3	1	0	0	2	2
Cap, veh/h				541	0	491	192	1035	0	0	531	141
Arrive On Green				0.32	0.00	0.32	0.11	0.55	0.00	0.00	0.37	0.34
Sat Flow, veh/h				1707	0	1550	1757	1881	0	0	1419	377
Grp Volume(v), veh/h				259	0	323	159	364	0	0	0	481
Grp Sat Flow(s),veh/h/ln				1707	0	1550	1757	1881	0	0	0	1796
Q Serve(g_s), s				7.3	0.0	10.8	5.3	6.5	0.0	0.0	0.0	13.8
Cycle Q Clear(g_c), s				7.3	0.0	10.8	5.3	6.5	0.0	0.0	0.0	13.8
Prop In Lane				1.00		1.00	1.00		0.00	0.00		0.21
Lane Grp Cap(c), veh/h				541	0	491	192	1035	0	0	0	672
V/C Ratio(X)				0.48	0.00	0.66	0.83	0.35	0.00	0.00	0.00	0.72
Avail Cap(c_a), veh/h				541	0	491	246	1035	0	0	0	672
HCM Platoon Ratio				1.00	1.00	1.00	1.00	1.00	1.00	1.00	1.00	1.00
Upstream Filter(I)				1.00	0.00	1.00	1.00	1.00	0.00	0.00	0.00	1.00
Uniform Delay (d), s/veh				16.5	0.0	17.7	26.2	7.5	0.0	0.0	0.0	16.3
Incr Delay (d2), s/veh				3.0	0.0	6.8	16.6	0.9	0.0	0.0	0.0	3.6
Initial Q Delay(d3),s/veh				0.0	0.0	0.0	0.0	0.0	0.0	0.0	0.0	0.0
%ile BackOfQ(50%),veh/ln				3.9	0.0	5.5	3.4	3.6	0.0	0.0	0.0	7.5
LnGrp Delay(d),s/veh				19.5	0.0	24.5	42.7	8.5	0.0	0.0	0.0	19.9
LnGrp LOS				B		C	D	A				B
Approach Vol, veh/h					582			523			481	
Approach Delay, s/veh					22.3			18.9			19.9	
Approach LOS					C			B			B	
Timer	1	2	3	4	5	6	7	8				
Assigned Phs	1	2		4		6						
Phs Duration (G+Y+Rc), s	10.6	26.4		23.0		37.0						
Change Period (Y+Rc), s	3.7	6.0		4.9		6.0						
Max Green Setting (Gmax), s	8.7	18.6		18.1		31.0						
Max Q Clear Time (g_c+I1), s	7.3	15.8		12.8		8.5						
Green Ext Time (p_c), s	0.1	0.6		1.2		1.2						
Intersection Summary												
HCM 2010 Ctrl Delay				20.4								
HCM 2010 LOS				C								







HCM 2010 Signalized Intersection Summary
 2: River Rd. & Hwy 68 EB Ramps

Existing + Project AM.syn
 01/17/2022

												
Movement	EBL	EBT	EBR	WBL	WBT	WBR	NBL	NBT	NBR	SBL	SBT	SBR
Lane Configurations												
Traffic Volume (veh/h)	113	0	97	0	0	0	0	342	703	216	339	0
Future Volume (veh/h)	113	0	97	0	0	0	0	342	703	216	339	0
Number	3	8	18				1	6	16	5	2	12
Initial Q (Qb), veh	0	0	0				0	0	0	0	0	0
Ped-Bike Adj(A_pbT)	1.00		1.00				1.00		1.00	1.00		1.00
Parking Bus, Adj	1.00		1.00				1.00		1.00	1.00	1.00	1.00
Adj Sat Flow, veh/h/ln	1900	1900	1845				0	1863	1881	1845	1845	0
Adj Flow Rate, veh/h	138	0	118				0	417	857	263	413	0
Adj No. of Lanes	0	1	1				0	1	1	1	1	0
Peak Hour Factor	0.82	0.82	0.82				0.82	0.82	0.82	0.82	0.82	0.82
Percent Heavy Veh, %	0	2	3				0	2	1	3	3	0
Cap, veh/h	198	0	172				0	1126	966	290	1493	0
Arrive On Green	0.11	0.00	0.11				0.00	0.60	0.60	0.16	0.81	0.00
Sat Flow, veh/h	1810	0	1568				0	1863	1599	1757	1845	0
Grp Volume(v), veh/h	138	0	118				0	417	857	263	413	0
Grp Sat Flow(s),veh/h/ln	1810	0	1568				0	1863	1599	1757	1845	0
Q Serve(g_s), s	7.3	0.0	7.2				0.0	11.3	45.2	14.5	5.4	0.0
Cycle Q Clear(g_c), s	7.3	0.0	7.2				0.0	11.3	45.2	14.5	5.4	0.0
Prop In Lane	1.00		1.00				0.00		1.00	1.00		0.00
Lane Grp Cap(c), veh/h	198	0	172				0	1126	966	290	1493	0
V/C Ratio(X)	0.70	0.00	0.69				0.00	0.37	0.89	0.91	0.28	0.00
Avail Cap(c_a), veh/h	401	0	347				0	1126	966	302	1493	0
HCM Platoon Ratio	1.00	1.00	1.00				1.00	1.00	1.00	1.00	1.00	1.00
Upstream Filter(I)	1.00	0.00	1.00				0.00	1.00	1.00	1.00	1.00	0.00
Uniform Delay (d), s/veh	42.5	0.0	42.4				0.0	10.0	16.7	40.6	2.3	0.0
Incr Delay (d2), s/veh	4.4	0.0	4.8				0.0	0.2	10.0	28.9	0.5	0.0
Initial Q Delay(d3),s/veh	0.0	0.0	0.0				0.0	0.0	0.0	0.0	0.0	0.0
%ile BackOfQ(50%),veh/ln	3.9	0.0	3.3				0.0	5.9	22.5	9.4	2.9	0.0
LnGrp Delay(d),s/veh	46.8	0.0	47.2				0.0	10.2	26.7	69.5	2.8	0.0
LnGrp LOS	D		D					B	C	E	A	
Approach Vol, veh/h		256						1274			676	
Approach Delay, s/veh		47.0						21.3			28.7	
Approach LOS		D						C			C	
Timer	1	2	3	4	5	6	7	8				
Assigned Phs		2			5	6		8				
Phs Duration (G+Y+Rc), s		84.1			20.3	63.8		14.8				
Change Period (Y+Rc), s		6.0			3.7	6.0		4.9				
Max Green Setting (Gmax), s		78.1			17.3	57.1		21.0				
Max Q Clear Time (g_c+I1), s		7.4			16.5	47.2		9.3				
Green Ext Time (p_c), s		1.5			0.1	4.4		0.7				
Intersection Summary												
HCM 2010 Ctrl Delay			26.6									
HCM 2010 LOS			C									

HCM 2010 Signalized Intersection Summary
 3: Las Palmas Rd & River Rd.

Existing + Project AM.syn
 01/17/2022

								
Movement	EBT	EBR	WBL	WBT	NBL	NBR		
Lane Configurations	↑↑	↑	↑	↑↑	↑	↑		
Traffic Volume (veh/h)	407	40	8	921	123	13		
Future Volume (veh/h)	407	40	8	921	123	13		
Number	2	12	1	6	3	18		
Initial Q (Qb), veh	0	0	0	0	0	0		
Ped-Bike Adj(A_pbT)		1.00	1.00		1.00	1.00		
Parking Bus, Adj	1.00	1.00	1.00	1.00	1.00	1.00		
Adj Sat Flow, veh/h/ln	1792	1792	1900	1863	1900	1900		
Adj Flow Rate, veh/h	457	45	9	1035	138	15		
Adj No. of Lanes	2	1	1	2	1	1		
Peak Hour Factor	0.89	0.89	0.89	0.89	0.89	0.89		
Percent Heavy Veh, %	6	6	0	2	0	0		
Cap, veh/h	1231	550	18	1927	196	175		
Arrive On Green	0.36	0.36	0.01	0.54	0.11	0.11		
Sat Flow, veh/h	3495	1521	1810	3632	1810	1615		
Grp Volume(v), veh/h	457	45	9	1035	138	15		
Grp Sat Flow(s),veh/h/ln	1703	1521	1810	1770	1810	1615		
Q Serve(g_s), s	2.3	0.4	0.1	4.3	1.7	0.2		
Cycle Q Clear(g_c), s	2.3	0.4	0.1	4.3	1.7	0.2		
Prop In Lane		1.00	1.00		1.00	1.00		
Lane Grp Cap(c), veh/h	1231	550	18	1927	196	175		
V/C Ratio(X)	0.37	0.08	0.51	0.54	0.70	0.09		
Avail Cap(c_a), veh/h	2511	1122	314	3838	549	490		
HCM Platoon Ratio	1.00	1.00	1.00	1.00	1.00	1.00		
Upstream Filter(I)	1.00	1.00	1.00	1.00	1.00	1.00		
Uniform Delay (d), s/veh	5.4	4.8	11.4	3.4	9.9	9.2		
Incr Delay (d2), s/veh	0.2	0.1	21.2	0.2	4.6	0.2		
Initial Q Delay(d3),s/veh	0.0	0.0	0.0	0.0	0.0	0.0		
%ile BackOfQ(50%),veh/ln	1.0	0.2	0.2	2.1	1.1	0.1		
LnGrp Delay(d),s/veh	5.6	4.9	32.5	3.6	14.5	9.5		
LnGrp LOS	A	A	C	A	B	A		
Approach Vol, veh/h	502			1044	153			
Approach Delay, s/veh	5.6			3.9	14.0			
Approach LOS	A			A	B			
Timer	1	2	3	4	5	6	7	8
Assigned Phs	1	2				6		8
Phs Duration (G+Y+Rc), s	4.2	12.3				16.6		6.5
Change Period (Y+Rc), s	4.0	4.0				4.0		4.0
Max Green Setting (Gmax), s	4.0	17.0				25.0		7.0
Max Q Clear Time (g_c+I1), s	2.1	4.3				6.3		3.7
Green Ext Time (p_c), s	0.0	2.2				6.2		0.1
Intersection Summary								
HCM 2010 Ctrl Delay			5.3					
HCM 2010 LOS			A					



















HCM 2010 Signalized Intersection Summary
 1: Hwy 68 WB Ramps & Reservation Rd.

Existing + Project PM.syn
 01/17/2022

Movement	EBL	EBT	EBR	WBL	WBT	WBR	NBL	NBT	NBR	SBL	SBT	SBR
Lane Configurations												
Traffic Volume (veh/h)	0	0	0	452	0	239	109	219	0	0	530	134
Future Volume (veh/h)	0	0	0	452	0	239	109	219	0	0	530	134
Number				7	4	14	1	6	16	5	2	12
Initial Q (Qb), veh				0	0	0	0	0	0	0	0	0
Ped-Bike Adj(A_pbT)				1.00		1.00	1.00		1.00	1.00		1.00
Parking Bus, Adj				1.00	1.00	1.00	1.00	1.00	1.00	1.00	1.00	1.00
Adj Sat Flow, veh/h/ln				1900	1900	1900	1863	1810	0	0	1881	1900
Adj Flow Rate, veh/h				491	0	260	118	238	0	0	576	146
Adj No. of Lanes				0	1	1	1	1	0	0	1	0
Peak Hour Factor				0.92	0.92	0.92	0.92	0.92	0.92	0.92	0.92	0.92
Percent Heavy Veh, %				0	0	0	2	5	0	0	1	1
Cap, veh/h				555	0	495	142	1062	0	0	657	167
Arrive On Green				0.31	0.00	0.31	0.08	0.59	0.00	0.00	0.45	0.43
Sat Flow, veh/h				1810	0	1615	1774	1810	0	0	1449	367
Grp Volume(v), veh/h				491	0	260	118	238	0	0	0	722
Grp Sat Flow(s),veh/h/ln				1810	0	1615	1774	1810	0	0	0	1816
Q Serve(g_s), s				19.4	0.0	10.0	4.9	4.7	0.0	0.0	0.0	27.1
Cycle Q Clear(g_c), s				19.4	0.0	10.0	4.9	4.7	0.0	0.0	0.0	27.1
Prop In Lane				1.00		1.00	1.00		0.00	0.00		0.20
Lane Grp Cap(c), veh/h				555	0	495	142	1062	0	0	0	823
V/C Ratio(X)				0.88	0.00	0.52	0.83	0.22	0.00	0.00	0.00	0.88
Avail Cap(c_a), veh/h				555	0	495	142	1062	0	0	0	823
HCM Platoon Ratio				1.00	1.00	1.00	1.00	1.00	1.00	1.00	1.00	1.00
Upstream Filter(I)				1.00	0.00	1.00	1.00	1.00	0.00	0.00	0.00	1.00
Uniform Delay (d), s/veh				24.7	0.0	21.5	34.0	7.4	0.0	0.0	0.0	18.8
Incr Delay (d2), s/veh				18.4	0.0	3.9	32.3	0.5	0.0	0.0	0.0	10.5
Initial Q Delay(d3),s/veh				0.0	0.0	0.0	0.0	0.0	0.0	0.0	0.0	0.0
%ile BackOfQ(50%),veh/ln				12.4	0.0	4.9	3.7	2.5	0.0	0.0	0.0	15.9
LnGrp Delay(d),s/veh				43.1	0.0	25.4	66.3	7.9	0.0	0.0	0.0	29.3
LnGrp LOS				D		C	E	A				C
Approach Vol, veh/h					751			356			722	
Approach Delay, s/veh					37.0			27.2			29.3	
Approach LOS					D			C			C	
Timer	1	2	3	4	5	6	7	8				
Assigned Phs	1	2		4		6						
Phs Duration (G+Y+Rc), s	10.0	38.0		27.0		48.0						
Change Period (Y+Rc), s	3.7	6.0		4.9		6.0						
Max Green Setting (Gmax), s	6.3	32.0		22.1		42.0						
Max Q Clear Time (g_c+I1), s	6.9	29.1		21.4		6.7						
Green Ext Time (p_c), s	0.0	1.0		0.3		0.8						
Intersection Summary												
HCM 2010 Ctrl Delay				32.1								
HCM 2010 LOS				C								







HCM 2010 Signalized Intersection Summary
 2: River Rd. & Hwy 68 EB Ramps

Existing + Project PM.syn
 01/17/2022

												
Movement	EBL	EBT	EBR	WBL	WBT	WBR	NBL	NBT	NBR	SBL	SBT	SBR
Lane Configurations												
Traffic Volume (veh/h)	69	0	206	0	0	0	0	259	330	252	729	0
Future Volume (veh/h)	69	0	206	0	0	0	0	259	330	252	729	0
Number	3	8	18				1	6	16	5	2	12
Initial Q (Qb), veh	0	0	0				0	0	0	0	0	0
Ped-Bike Adj(A_pbT)	1.00		1.00				1.00		1.00	1.00		1.00
Parking Bus, Adj	1.00	1.00	1.00				1.00	1.00	1.00	1.00	1.00	1.00
Adj Sat Flow, veh/h/ln	1900	1900	1900				0	1881	1881	1863	1900	0
Adj Flow Rate, veh/h	73	0	219				0	276	351	268	776	0
Adj No. of Lanes	0	1	1				0	1	1	1	1	0
Peak Hour Factor	0.94	0.94	0.94				0.94	0.94	0.94	0.94	0.94	0.94
Percent Heavy Veh, %	0	0	0				0	1	1	2	0	0
Cap, veh/h	351	0	314				0	755	642	319	1247	0
Arrive On Green	0.19	0.00	0.19				0.00	0.40	0.40	0.18	0.66	0.00
Sat Flow, veh/h	1810	0	1615				0	1881	1599	1774	1900	0
Grp Volume(v), veh/h	73	0	219				0	276	351	268	776	0
Grp Sat Flow(s),veh/h/ln	1810	0	1615				0	1881	1599	1774	1900	0
Q Serve(g_s), s	1.8	0.0	6.8				0.0	5.5	9.0	7.8	12.7	0.0
Cycle Q Clear(g_c), s	1.8	0.0	6.8				0.0	5.5	9.0	7.8	12.7	0.0
Prop In Lane	1.00		1.00				0.00		1.00	1.00		0.00
Lane Grp Cap(c), veh/h	351	0	314				0	755	642	319	1247	0
V/C Ratio(X)	0.21	0.00	0.70				0.00	0.37	0.55	0.84	0.62	0.00
Avail Cap(c_a), veh/h	741	0	661				0	755	642	431	1247	0
HCM Platoon Ratio	1.00	1.00	1.00				1.00	1.00	1.00	1.00	1.00	1.00
Upstream Filter(I)	1.00	0.00	1.00				0.00	1.00	1.00	1.00	1.00	0.00
Uniform Delay (d), s/veh	18.1	0.0	20.1				0.0	11.2	12.3	21.2	5.3	0.0
Incr Delay (d2), s/veh	0.3	0.0	2.8				0.0	0.3	1.0	10.5	2.3	0.0
Initial Q Delay(d3),s/veh	0.0	0.0	0.0				0.0	0.0	0.0	0.0	0.0	0.0
%ile BackOfQ(50%),veh/ln	0.9	0.0	3.2				0.0	2.9	4.1	4.7	7.3	0.0
LnGrp Delay(d),s/veh	18.4	0.0	22.9				0.0	11.5	13.2	31.7	7.7	0.0
LnGrp LOS	B		C					B	B	C	A	
Approach Vol, veh/h		292						627			1044	
Approach Delay, s/veh		21.8						12.5			13.8	
Approach LOS		C						B			B	
Timer	1	2	3	4	5	6	7	8				
Assigned Phs		2			5	6		8				
Phs Duration (G+Y+Rc), s		39.1			13.6	25.5		14.4				
Change Period (Y+Rc), s		6.0			3.7	6.0		4.9				
Max Green Setting (Gmax), s		33.1			13.3	16.1		21.0				
Max Q Clear Time (g_c+I1), s		14.7			9.8	11.0		8.8				
Green Ext Time (p_c), s		3.1			0.3	1.2		0.8				
Intersection Summary												
HCM 2010 Ctrl Delay			14.6									
HCM 2010 LOS			B									

















HCM 2010 Signalized Intersection Summary
3: Las Palmas Rd & River Rd.

Existing + Project PM.syn
01/17/2022

								
Movement	EBT	EBR	WBL	WBT	NBL	NBR		
Lane Configurations	↑↑	↑	↑	↑↑	↑	↑		
Traffic Volume (veh/h)	816	112	10	536	53	6		
Future Volume (veh/h)	816	112	10	536	53	6		
Number	2	12	1	6	3	18		
Initial Q (Qb), veh	0	0	0	0	0	0		
Ped-Bike Adj(A_pbT)		1.00	1.00		1.00	1.00		
Parking Bus, Adj	1.00	1.00	1.00	1.00	1.00	1.00		
Adj Sat Flow, veh/h/ln	1881	1881	1900	1845	1900	1900		
Adj Flow Rate, veh/h	859	118	11	564	56	6		
Adj No. of Lanes	2	1	1	2	1	1		
Peak Hour Factor	0.95	0.95	0.95	0.95	0.95	0.95		
Percent Heavy Veh, %	1	1	0	3	0	0		
Cap, veh/h	1578	706	21	2162	102	91		
Arrive On Green	0.44	0.44	0.01	0.62	0.06	0.06		
Sat Flow, veh/h	3668	1599	1810	3597	1810	1615		
Grp Volume(v), veh/h	859	118	11	564	56	6		
Grp Sat Flow(s),veh/h/ln	1787	1599	1810	1752	1810	1615		
Q Serve(g_s), s	4.3	1.1	0.1	1.8	0.7	0.1		
Cycle Q Clear(g_c), s	4.3	1.1	0.1	1.8	0.7	0.1		
Prop In Lane		1.00	1.00		1.00	1.00		
Lane Grp Cap(c), veh/h	1578	706	21	2162	102	91		
V/C Ratio(X)	0.54	0.17	0.52	0.26	0.55	0.07		
Avail Cap(c_a), veh/h	2775	1242	296	3867	370	330		
HCM Platoon Ratio	1.00	1.00	1.00	1.00	1.00	1.00		
Upstream Filter(I)	1.00	1.00	1.00	1.00	1.00	1.00		
Uniform Delay (d), s/veh	5.0	4.1	12.0	2.1	11.2	10.9		
Incr Delay (d2), s/veh	0.3	0.1	18.0	0.1	4.6	0.3		
Initial Q Delay(d3),s/veh	0.0	0.0	0.0	0.0	0.0	0.0		
%ile BackOfQ(50%),veh/ln	2.1	0.5	0.2	0.9	0.5	0.0		
LnGrp Delay(d),s/veh	5.3	4.2	30.0	2.2	15.8	11.2		
LnGrp LOS	A	A	C	A	B	B		
Approach Vol, veh/h	977			575	62			
Approach Delay, s/veh	5.2			2.7	15.4			
Approach LOS	A			A	B			
Timer	1	2	3	4	5	6	7	8
Assigned Phs	1	2				6		8
Phs Duration (G+Y+Rc), s	4.3	14.8				19.1		5.4
Change Period (Y+Rc), s	4.0	4.0				4.0		4.0
Max Green Setting (Gmax), s	4.0	19.0				27.0		5.0
Max Q Clear Time (g_c+I1), s	2.1	6.3				3.8		2.7
Green Ext Time (p_c), s	0.0	4.5				3.2		0.0
Intersection Summary								
HCM 2010 Ctrl Delay			4.7					
HCM 2010 LOS			A					



















HCM 2010 Signalized Intersection Summary
 1: Hwy 68 WB Ramps & Reservation Rd.

Cumulative + Project AM.syn
 01/17/2022

												
Movement	EBL	EBT	EBR	WBL	WBT	WBR	NBL	NBT	NBR	SBL	SBT	SBR
Lane Configurations												
Traffic Volume (veh/h)	0	0	0	258	0	323	158	364	0	0	380	101
Future Volume (veh/h)	0	0	0	258	0	323	158	364	0	0	380	101
Number				7	4	14	1	6	16	5	2	12
Initial Q (Qb), veh				0	0	0	0	0	0	0	0	0
Ped-Bike Adj(A_pbT)				1.00		0.98	1.00		1.00	1.00		1.00
Parking Bus, Adj				1.00	1.00	1.00	1.00	1.00	1.00	1.00	1.00	1.00
Adj Sat Flow, veh/h/ln				1900	1792	1863	1845	1881	0	0	1863	1900
Adj Flow Rate, veh/h				297	0	371	182	418	0	0	437	116
Adj No. of Lanes				0	1	1	1	1	0	0	1	0
Peak Hour Factor				0.87	0.87	0.87	0.87	0.87	0.87	0.87	0.87	0.87
Percent Heavy Veh, %				6	0	2	3	1	0	0	2	2
Cap, veh/h				525	0	477	216	1071	0	0	546	145
Arrive On Green				0.31	0.00	0.31	0.12	0.57	0.00	0.00	0.38	0.35
Sat Flow, veh/h				1707	0	1550	1757	1881	0	0	1419	377
Grp Volume(v), veh/h				297	0	371	182	418	0	0	0	553
Grp Sat Flow(s),veh/h/ln				1707	0	1550	1757	1881	0	0	0	1796
Q Serve(g_s), s				9.5	0.0	14.2	6.6	8.0	0.0	0.0	0.0	17.8
Cycle Q Clear(g_c), s				9.5	0.0	14.2	6.6	8.0	0.0	0.0	0.0	17.8
Prop In Lane				1.00		1.00	1.00		0.00	0.00		0.21
Lane Grp Cap(c), veh/h				525	0	477	216	1071	0	0	0	691
V/C Ratio(X)				0.57	0.00	0.78	0.84	0.39	0.00	0.00	0.00	0.80
Avail Cap(c_a), veh/h				525	0	477	243	1071	0	0	0	691
HCM Platoon Ratio				1.00	1.00	1.00	1.00	1.00	1.00	1.00	1.00	1.00
Upstream Filter(I)				1.00	0.00	1.00	1.00	1.00	0.00	0.00	0.00	1.00
Uniform Delay (d), s/veh				18.9	0.0	20.5	27.9	7.8	0.0	0.0	0.0	18.0
Incr Delay (d2), s/veh				4.4	0.0	11.8	20.7	1.1	0.0	0.0	0.0	6.7
Initial Q Delay(d3),s/veh				0.0	0.0	0.0	0.0	0.0	0.0	0.0	0.0	0.0
%ile BackOfQ(50%),veh/ln				5.1	0.0	7.5	4.4	4.4	0.0	0.0	0.0	10.1
LnGrp Delay(d),s/veh				23.2	0.0	32.3	48.6	8.8	0.0	0.0	0.0	24.7
LnGrp LOS				C		C	D	A				C
Approach Vol, veh/h					668			600			553	
Approach Delay, s/veh					28.3			20.9			24.7	
Approach LOS					C			C			C	
Timer	1	2	3	4	5	6	7	8				
Assigned Phs	1	2		4		6						
Phs Duration (G+Y+Rc), s	12.0	29.0		24.0		41.0						
Change Period (Y+Rc), s	3.7	6.0		4.9		6.0						
Max Green Setting (Gmax), s	9.3	22.0		19.1		35.0						
Max Q Clear Time (g_c+I1), s	8.6	19.8		16.2		10.0						
Green Ext Time (p_c), s	0.0	0.5		0.9		1.5						
Intersection Summary												
HCM 2010 Ctrl Delay				24.7								
HCM 2010 LOS				C								







HCM 2010 Signalized Intersection Summary
 2: River Rd. & Hwy 68 EB Ramps

Cumulative + Project AM.syn
 01/17/2022

												
Movement	EBL	EBT	EBR	WBL	WBT	WBR	NBL	NBT	NBR	SBL	SBT	SBR
Lane Configurations												
Traffic Volume (veh/h)	130	0	111	0	0	0	0	392	808	248	389	0
Future Volume (veh/h)	130	0	111	0	0	0	0	392	808	248	389	0
Number	3	8	18				1	6	16	5	2	12
Initial Q (Qb), veh	0	0	0				0	0	0	0	0	0
Ped-Bike Adj(A_pbT)	1.00		1.00				1.00		1.00	1.00		1.00
Parking Bus, Adj	1.00	1.00	1.00				1.00	1.00	1.00	1.00	1.00	1.00
Adj Sat Flow, veh/h/ln	1900	1900	1845				0	1863	1881	1845	1845	0
Adj Flow Rate, veh/h	159	0	135				0	478	985	302	474	0
Adj No. of Lanes	0	1	1				0	1	1	1	1	0
Peak Hour Factor	0.82	0.82	0.82				0.82	0.82	0.82	0.82	0.82	0.82
Percent Heavy Veh, %	0	2	3				0	2	1	3	3	0
Cap, veh/h	199	0	172				0	1166	1001	317	1539	0
Arrive On Green	0.11	0.00	0.11				0.00	0.63	0.63	0.18	0.83	0.00
Sat Flow, veh/h	1810	0	1568				0	1863	1599	1757	1845	0
Grp Volume(v), veh/h	159	0	135				0	478	985	302	474	0
Grp Sat Flow(s),veh/h/ln	1810	0	1568				0	1863	1599	1757	1845	0
Q Serve(g_s), s	12.3	0.0	12.1				0.0	18.6	86.3	24.5	8.2	0.0
Cycle Q Clear(g_c), s	12.3	0.0	12.1				0.0	18.6	86.3	24.5	8.2	0.0
Prop In Lane	1.00		1.00				0.00		1.00	1.00		0.00
Lane Grp Cap(c), veh/h	199	0	172				0	1166	1001	317	1539	0
V/C Ratio(X)	0.80	0.00	0.78				0.00	0.41	0.98	0.95	0.31	0.00
Avail Cap(c_a), veh/h	275	0	239				0	1166	1001	317	1539	0
HCM Platoon Ratio	1.00	1.00	1.00				1.00	1.00	1.00	1.00	1.00	1.00
Upstream Filter(I)	1.00	0.00	1.00				0.00	1.00	1.00	1.00	1.00	0.00
Uniform Delay (d), s/veh	62.5	0.0	62.4				0.0	13.5	26.2	58.3	2.7	0.0
Incr Delay (d2), s/veh	10.9	0.0	10.9				0.0	0.2	24.5	37.7	0.5	0.0
Initial Q Delay(d3),s/veh	0.0	0.0	0.0				0.0	0.0	0.0	0.0	0.0	0.0
%ile BackOfQ(50%),veh/ln	6.8	0.0	5.8				0.0	9.6	44.6	15.2	4.3	0.0
LnGrp Delay(d),s/veh	73.4	0.0	73.2				0.0	13.8	50.7	96.0	3.2	0.0
LnGrp LOS	E		E					B	D	F	A	
Approach Vol, veh/h		294						1463			776	
Approach Delay, s/veh		73.3						38.6			39.3	
Approach LOS		E						D			D	
Timer	1	2	3	4	5	6	7	8				
Assigned Phs		2			5	6		8				
Phs Duration (G+Y+Rc), s		124.1			30.0	94.1		19.8				
Change Period (Y+Rc), s		6.0			3.7	6.0		4.9				
Max Green Setting (Gmax), s		118.1			26.3	88.1		21.0				
Max Q Clear Time (g_c+I1), s		10.2			26.5	88.3		14.3				
Green Ext Time (p_c), s		1.8			0.0	0.0		0.6				
Intersection Summary												
HCM 2010 Ctrl Delay			42.9									
HCM 2010 LOS			D									

















HCM 2010 Signalized Intersection Summary
 3: Las Palmas Rd & River Rd.

Cumulative + Project AM.syn
 01/17/2022

								
Movement	EBT	EBR	WBL	WBT	NBL	NBR		
Lane Configurations	↑↑	↑	↑	↑↑	↑	↑		
Traffic Volume (veh/h)	468	45	9	1059	140	15		
Future Volume (veh/h)	468	45	9	1059	140	15		
Number	2	12	1	6	3	18		
Initial Q (Qb), veh	0	0	0	0	0	0		
Ped-Bike Adj(A_pbT)		1.00	1.00		1.00	1.00		
Parking Bus, Adj	1.00	1.00	1.00	1.00	1.00	1.00		
Adj Sat Flow, veh/h/ln	1792	1792	1900	1863	1900	1900		
Adj Flow Rate, veh/h	526	51	10	1190	157	17		
Adj No. of Lanes	2	1	1	2	1	1		
Peak Hour Factor	0.89	0.89	0.89	0.89	0.89	0.89		
Percent Heavy Veh, %	6	6	0	2	0	0		
Cap, veh/h	1363	609	19	2009	215	192		
Arrive On Green	0.40	0.40	0.01	0.57	0.12	0.12		
Sat Flow, veh/h	3495	1522	1810	3632	1810	1615		
Grp Volume(v), veh/h	526	51	10	1190	157	17		
Grp Sat Flow(s),veh/h/ln	1703	1522	1810	1770	1810	1615		
Q Serve(g_s), s	2.8	0.5	0.1	5.6	2.1	0.2		
Cycle Q Clear(g_c), s	2.8	0.5	0.1	5.6	2.1	0.2		
Prop In Lane		1.00	1.00		1.00	1.00		
Lane Grp Cap(c), veh/h	1363	609	19	2009	215	192		
V/C Ratio(X)	0.39	0.08	0.52	0.59	0.73	0.09		
Avail Cap(c_a), veh/h	2135	954	284	3329	567	506		
HCM Platoon Ratio	1.00	1.00	1.00	1.00	1.00	1.00		
Upstream Filter(I)	1.00	1.00	1.00	1.00	1.00	1.00		
Uniform Delay (d), s/veh	5.4	4.8	12.6	3.6	10.8	10.0		
Incr Delay (d2), s/veh	0.2	0.1	19.5	0.3	4.7	0.2		
Initial Q Delay(d3),s/veh	0.0	0.0	0.0	0.0	0.0	0.0		
%ile BackOfQ(50%),veh/ln	1.3	0.2	0.2	2.7	1.3	0.1		
LnGrp Delay(d),s/veh	5.6	4.8	32.1	3.9	15.5	10.2		
LnGrp LOS	A	A	C	A	B	B		
Approach Vol, veh/h	577			1200	174			
Approach Delay, s/veh	5.5			4.1	15.0			
Approach LOS	A			A	B			
Timer	1	2	3	4	5	6	7	8
Assigned Phs	1	2				6		8
Phs Duration (G+Y+Rc), s	4.3	14.2				18.5		7.0
Change Period (Y+Rc), s	4.0	4.0				4.0		4.0
Max Green Setting (Gmax), s	4.0	16.0				24.0		8.0
Max Q Clear Time (g_c+1), s	2.1	4.8				7.6		4.1
Green Ext Time (p_c), s	0.0	2.4				6.9		0.1
Intersection Summary								
HCM 2010 Ctrl Delay			5.5					
HCM 2010 LOS			A					



















HCM 2010 Signalized Intersection Summary
 1: Hwy 68 WB Ramps & Reservation Rd.

Cumulative + Project PM.syn
 01/17/2022

												
Movement	EBL	EBT	EBR	WBL	WBT	WBR	NBL	NBT	NBR	SBL	SBT	SBR
Lane Configurations												
Traffic Volume (veh/h)	0	0	0	519	0	275	125	251	0	0	609	154
Future Volume (veh/h)	0	0	0	519	0	275	125	251	0	0	609	154
Number				7	4	14	1	6	16	5	2	12
Initial Q (Qb), veh				0	0	0	0	0	0	0	0	0
Ped-Bike Adj(A_pbT)				1.00		1.00	1.00		1.00	1.00		1.00
Parking Bus, Adj				1.00	1.00	1.00	1.00	1.00	1.00	1.00	1.00	1.00
Adj Sat Flow, veh/h/ln				1900	1900	1900	1863	1810	0	0	1881	1900
Adj Flow Rate, veh/h				564	0	299	136	273	0	0	662	167
Adj No. of Lanes				0	1	1	1	1	0	0	1	0
Peak Hour Factor				0.92	0.92	0.92	0.92	0.92	0.92	0.92	0.92	0.92
Percent Heavy Veh, %				0	0	0	2	5	0	0	1	1
Cap, veh/h				585	0	522	156	1064	0	0	661	167
Arrive On Green				0.32	0.00	0.32	0.09	0.59	0.00	0.00	0.46	0.43
Sat Flow, veh/h				1810	0	1615	1774	1810	0	0	1451	366
Grp Volume(v), veh/h				564	0	299	136	273	0	0	0	829
Grp Sat Flow(s),veh/h/ln				1810	0	1615	1774	1810	0	0	0	1817
Q Serve(g_s), s				27.6	0.0	13.8	6.8	6.6	0.0	0.0	0.0	41.0
Cycle Q Clear(g_c), s				27.6	0.0	13.8	6.8	6.6	0.0	0.0	0.0	41.0
Prop In Lane				1.00		1.00	1.00		0.00	0.00		0.20
Lane Grp Cap(c), veh/h				585	0	522	156	1064	0	0	0	828
V/C Ratio(X)				0.96	0.00	0.57	0.87	0.26	0.00	0.00	0.00	1.00
Avail Cap(c_a), veh/h				585	0	522	156	1064	0	0	0	828
HCM Platoon Ratio				1.00	1.00	1.00	1.00	1.00	1.00	1.00	1.00	1.00
Upstream Filter(l)				1.00	0.00	1.00	1.00	1.00	0.00	0.00	0.00	1.00
Uniform Delay (d), s/veh				29.9	0.0	25.3	40.6	9.0	0.0	0.0	0.0	24.7
Incr Delay (d2), s/veh				29.3	0.0	4.5	38.2	0.6	0.0	0.0	0.0	31.7
Initial Q Delay(d3),s/veh				0.0	0.0	0.0	0.0	0.0	0.0	0.0	0.0	0.0
%ile BackOfQ(50%),veh/ln				18.6	0.0	6.8	5.0	3.4	0.0	0.0	0.0	27.7
LnGrp Delay(d),s/veh				59.2	0.0	29.8	78.8	9.6	0.0	0.0	0.0	56.4
LnGrp LOS				E		C	E	A				F
Approach Vol, veh/h					863			409			829	
Approach Delay, s/veh					49.0			32.6			56.4	
Approach LOS					D			C			E	
Timer	1	2	3	4	5	6	7	8				
Assigned Phs	1	2		4		6						
Phs Duration (G+Y+Rc), s	11.9	45.0		33.1		56.9						
Change Period (Y+Rc), s	3.7	6.0		4.9		6.0						
Max Green Setting (Gmax), s	8.2	39.0		28.2		50.9						
Max Q Clear Time (g_c+I1), s	8.8	43.0		29.6		8.6						
Green Ext Time (p_c), s	0.0	0.0		0.0		0.9						
Intersection Summary												
HCM 2010 Ctrl Delay				48.7								
HCM 2010 LOS				D								







HCM 2010 Signalized Intersection Summary
 2: River Rd. & Hwy 68 EB Ramps

Cumulative + Project PM.syn
 01/17/2022

												
Movement	EBL	EBT	EBR	WBL	WBT	WBR	NBL	NBT	NBR	SBL	SBT	SBR
Lane Configurations												
Traffic Volume (veh/h)	79	0	236	0	0	0	0	297	379	290	837	0
Future Volume (veh/h)	79	0	236	0	0	0	0	297	379	290	837	0
Number	3	8	18				1	6	16	5	2	12
Initial Q (Qb), veh	0	0	0				0	0	0	0	0	0
Ped-Bike Adj(A_pbT)	1.00		1.00				1.00		1.00	1.00		1.00
Parking Bus, Adj	1.00	1.00	1.00				1.00	1.00	1.00	1.00	1.00	1.00
Adj Sat Flow, veh/h/ln	1900	1900	1900				0	1881	1881	1863	1900	0
Adj Flow Rate, veh/h	84	0	251				0	316	403	309	890	0
Adj No. of Lanes	0	1	1				0	1	1	1	1	0
Peak Hour Factor	0.94	0.94	0.94				0.94	0.94	0.94	0.94	0.94	0.94
Percent Heavy Veh, %	0	0	0				0	1	1	2	0	0
Cap, veh/h	376	0	336				0	740	629	356	1255	0
Arrive On Green	0.21	0.00	0.21				0.00	0.39	0.39	0.20	0.66	0.00
Sat Flow, veh/h	1810	0	1615				0	1881	1599	1774	1900	0
Grp Volume(v), veh/h	84	0	251				0	316	403	309	890	0
Grp Sat Flow(s),veh/h/ln	1810	0	1615				0	1881	1599	1774	1900	0
Q Serve(g_s), s	2.3	0.0	8.9				0.0	7.4	12.4	10.2	18.2	0.0
Cycle Q Clear(g_c), s	2.3	0.0	8.9				0.0	7.4	12.4	10.2	18.2	0.0
Prop In Lane	1.00		1.00				0.00		1.00	1.00		0.00
Lane Grp Cap(c), veh/h	376	0	336				0	740	629	356	1255	0
V/C Ratio(X)	0.22	0.00	0.75				0.00	0.43	0.64	0.87	0.71	0.00
Avail Cap(c_a), veh/h	653	0	582				0	740	629	438	1255	0
HCM Platoon Ratio	1.00	1.00	1.00				1.00	1.00	1.00	1.00	1.00	1.00
Upstream Filter(I)	1.00	0.00	1.00				0.00	1.00	1.00	1.00	1.00	0.00
Uniform Delay (d), s/veh	20.0	0.0	22.6				0.0	13.4	14.9	23.5	6.6	0.0
Incr Delay (d2), s/veh	0.3	0.0	3.3				0.0	0.4	2.2	14.3	3.4	0.0
Initial Q Delay(d3),s/veh	0.0	0.0	0.0				0.0	0.0	0.0	0.0	0.0	0.0
%ile BackOfQ(50%),veh/ln	1.2	0.0	4.2				0.0	3.9	5.8	6.4	10.6	0.0
LnGrp Delay(d),s/veh	20.3	0.0	25.9				0.0	13.8	17.1	37.7	10.0	0.0
LnGrp LOS	C		C					B	B	D	B	
Approach Vol, veh/h		335						719			1199	
Approach Delay, s/veh		24.5						15.7			17.2	
Approach LOS		C						B			B	
Timer	1	2	3	4	5	6	7	8				
Assigned Phs		2			5	6		8				
Phs Duration (G+Y+Rc), s		44.1			16.2	27.9		16.6				
Change Period (Y+Rc), s		6.0			3.7	6.0		4.9				
Max Green Setting (Gmax), s		38.1			15.3	19.1		21.0				
Max Q Clear Time (g_c+I1), s		20.2			12.2	14.4		10.9				
Green Ext Time (p_c), s		3.8			0.3	1.3		0.9				
Intersection Summary												
HCM 2010 Ctrl Delay			17.8									
HCM 2010 LOS			B									



















HCM 2010 Signalized Intersection Summary
 3: Las Palmas Rd & River Rd.

Cumulative + Project PM.syn
 01/17/2022

								
Movement	EBT	EBR	WBL	WBT	NBL	NBR		
Lane Configurations	↑↑	↑	↑	↑↑	↑	↑		
Traffic Volume (veh/h)	938	127	11	616	59	7		
Future Volume (veh/h)	938	127	11	616	59	7		
Number	2	12	1	6	3	18		
Initial Q (Qb), veh	0	0	0	0	0	0		
Ped-Bike Adj(A_pbT)		1.00	1.00		1.00	1.00		
Parking Bus, Adj	1.00	1.00	1.00	1.00	1.00	1.00		
Adj Sat Flow, veh/h/ln	1881	1881	1900	1845	1900	1900		
Adj Flow Rate, veh/h	987	134	12	648	62	7		
Adj No. of Lanes	2	1	1	2	1	1		
Peak Hour Factor	0.95	0.95	0.95	0.95	0.95	0.95		
Percent Heavy Veh, %	1	1	0	3	0	0		
Cap, veh/h	1676	750	23	2223	109	97		
Arrive On Green	0.47	0.47	0.01	0.63	0.06	0.06		
Sat Flow, veh/h	3668	1599	1810	3597	1810	1615		
Grp Volume(v), veh/h	987	134	12	648	62	7		
Grp Sat Flow(s),veh/h/ln	1787	1599	1810	1752	1810	1615		
Q Serve(g_s), s	5.3	1.3	0.2	2.2	0.9	0.1		
Cycle Q Clear(g_c), s	5.3	1.3	0.2	2.2	0.9	0.1		
Prop In Lane		1.00	1.00		1.00	1.00		
Lane Grp Cap(c), veh/h	1676	750	23	2223	109	97		
V/C Ratio(X)	0.59	0.18	0.52	0.29	0.57	0.07		
Avail Cap(c_a), veh/h	2593	1160	276	3613	345	308		
HCM Platoon Ratio	1.00	1.00	1.00	1.00	1.00	1.00		
Upstream Filter(I)	1.00	1.00	1.00	1.00	1.00	1.00		
Uniform Delay (d), s/veh	5.1	4.0	12.9	2.1	12.0	11.6		
Incr Delay (d2), s/veh	0.3	0.1	16.9	0.1	4.6	0.3		
Initial Q Delay(d3),s/veh	0.0	0.0	0.0	0.0	0.0	0.0		
%ile BackOfQ(50%),veh/ln	2.5	0.6	0.2	1.0	0.6	0.1		
LnGrp Delay(d),s/veh	5.4	4.1	29.7	2.2	16.6	11.9		
LnGrp LOS	A	A	C	A	B	B		
Approach Vol, veh/h	1121			660	69			
Approach Delay, s/veh	5.3			2.7	16.1			
Approach LOS	A			A	B			
Timer	1	2	3	4	5	6	7	8
Assigned Phs	1	2				6		8
Phs Duration (G+Y+Rc), s	4.3	16.3				20.6		5.6
Change Period (Y+Rc), s	4.0	4.0				4.0		4.0
Max Green Setting (Gmax), s	4.0	19.0				27.0		5.0
Max Q Clear Time (g_c+I1), s	2.2	7.3				4.2		2.9
Green Ext Time (p_c), s	0.0	5.0				3.8		0.0
Intersection Summary								
HCM 2010 Ctrl Delay			4.8					
HCM 2010 LOS			A					



















HCM 2010 Signalized Intersection Summary
 1: Hwy 68 WB Ramps & Reservation Rd.

Cumulative + Project AM-Miti_1.syn
 01/17/2022

												
Movement	EBL	EBT	EBR	WBL	WBT	WBR	NBL	NBT	NBR	SBL	SBT	SBR
Lane Configurations												
Traffic Volume (veh/h)	0	0	0	258	0	323	158	364	0	0	380	101
Future Volume (veh/h)	0	0	0	258	0	323	158	364	0	0	380	101
Number				7	4	14	1	6	16	5	2	12
Initial Q (Qb), veh				0	0	0	0	0	0	0	0	0
Ped-Bike Adj(A_pbT)				1.00		0.98	1.00		1.00	1.00		1.00
Parking Bus, Adj				1.00	1.00	1.00	1.00	1.00	1.00	1.00	1.00	1.00
Adj Sat Flow, veh/h/ln				1900	1792	1863	1845	1881	0	0	1863	1863
Adj Flow Rate, veh/h				297	0	371	182	418	0	0	437	116
Adj No. of Lanes				0	1	1	1	1	0	0	1	1
Peak Hour Factor				0.87	0.87	0.87	0.87	0.87	0.87	0.87	0.87	0.87
Percent Heavy Veh, %				6	0	2	3	1	0	0	2	2
Cap, veh/h				541	0	491	219	1035	0	0	669	516
Arrive On Green				0.32	0.00	0.32	0.12	0.55	0.00	0.00	0.36	0.33
Sat Flow, veh/h				1707	0	1550	1757	1881	0	0	1863	1583
Grp Volume(v), veh/h				297	0	371	182	418	0	0	437	116
Grp Sat Flow(s),veh/h/ln				1707	0	1550	1757	1881	0	0	1863	1583
Q Serve(g_s), s				8.6	0.0	12.9	6.1	7.7	0.0	0.0	11.8	3.2
Cycle Q Clear(g_c), s				8.6	0.0	12.9	6.1	7.7	0.0	0.0	11.8	3.2
Prop In Lane				1.00		1.00	1.00		0.00	0.00		1.00
Lane Grp Cap(c), veh/h				541	0	491	219	1035	0	0	669	516
V/C Ratio(X)				0.55	0.00	0.76	0.83	0.40	0.00	0.00	0.65	0.22
Avail Cap(c_a), veh/h				541	0	491	272	1035	0	0	669	516
HCM Platoon Ratio				1.00	1.00	1.00	1.00	1.00	1.00	1.00	1.00	1.00
Upstream Filter(I)				1.00	0.00	1.00	1.00	1.00	0.00	0.00	1.00	1.00
Uniform Delay (d), s/veh				17.0	0.0	18.4	25.7	7.8	0.0	0.0	16.1	14.7
Incr Delay (d2), s/veh				4.0	0.0	10.4	16.2	1.2	0.0	0.0	2.3	0.2
Initial Q Delay(d3),s/veh				0.0	0.0	0.0	0.0	0.0	0.0	0.0	0.0	0.0
%ile BackOfQ(50%), veh/ln				4.6	0.0	6.9	3.9	4.3	0.0	0.0	6.4	1.4
LnGrp Delay(d),s/veh				20.9	0.0	28.8	41.9	9.0	0.0	0.0	18.4	14.9
LnGrp LOS				C		C	D	A			B	B
Approach Vol, veh/h					668			600			553	
Approach Delay, s/veh					25.3			19.0			17.7	
Approach LOS					C			B			B	
Timer	1	2	3	4	5	6	7	8				
Assigned Phs	1	2		4		6						
Phs Duration (G+Y+Rc), s	11.5	25.5		23.0		37.0						
Change Period (Y+Rc), s	3.7	6.0		4.9		6.0						
Max Green Setting (Gmax), s	9.6	17.7		18.1		31.0						
Max Q Clear Time (g_c+1), s	8.1	13.8		14.9		9.7						
Green Ext Time (p_c), s	0.1	0.8		0.9		1.4						
Intersection Summary												
HCM 2010 Ctrl Delay				20.9								
HCM 2010 LOS				C								

HCM 2010 Signalized Intersection Summary
 2: River Rd. & Hwy 68 EB Ramps

Cumulative + Project AM-Miti_1.syn
 01/17/2022

												
Movement	EBL	EBT	EBR	WBL	WBT	WBR	NBL	NBT	NBR	SBL	SBT	SBR
Lane Configurations												
Traffic Volume (veh/h)	130	0	111	0	0	0	0	392	808	248	389	0
Future Volume (veh/h)	130	0	111	0	0	0	0	392	808	248	389	0
Number	3	8	18				1	6	16	5	2	12
Initial Q (Qb), veh	0	0	0				0	0	0	0	0	0
Ped-Bike Adj(A_pbT)	1.00		1.00				1.00		1.00	1.00		1.00
Parking Bus, Adj	1.00	1.00	1.00				1.00	1.00	1.00	1.00	1.00	1.00
Adj Sat Flow, veh/h/ln	1900	1900	1845				0	1863	1881	1845	1845	0
Adj Flow Rate, veh/h	159	0	135				0	478	985	302	474	0
Adj No. of Lanes	0	1	1				0	1	1	2	1	0
Peak Hour Factor	0.82	0.82	0.82				0.82	0.82	0.82	0.82	0.82	0.82
Percent Heavy Veh, %	0	2	3				0	2	1	3	3	0
Cap, veh/h	219	0	190				0	1223	1050	350	1474	0
Arrive On Green	0.12	0.00	0.12				0.00	0.66	0.66	0.10	0.80	0.00
Sat Flow, veh/h	1810	0	1568				0	1863	1599	3408	1845	0
Grp Volume(v), veh/h	159	0	135				0	478	985	302	474	0
Grp Sat Flow(s), veh/h/ln	1810	0	1568				0	1863	1599	1704	1845	0
Q Serve(g_s), s	8.5	0.0	8.3				0.0	11.9	55.3	8.7	7.0	0.0
Cycle Q Clear(g_c), s	8.5	0.0	8.3				0.0	11.9	55.3	8.7	7.0	0.0
Prop In Lane	1.00		1.00				0.00		1.00	1.00		0.00
Lane Grp Cap(c), veh/h	219	0	190				0	1223	1050	350	1474	0
V/C Ratio(X)	0.73	0.00	0.71				0.00	0.39	0.94	0.86	0.32	0.00
Avail Cap(c_a), veh/h	395	0	343				0	1223	1050	350	1474	0
HCM Platoon Ratio	1.00	1.00	1.00				1.00	1.00	1.00	1.00	1.00	1.00
Upstream Filter(I)	1.00	0.00	1.00				0.00	1.00	1.00	1.00	1.00	0.00
Uniform Delay (d), s/veh	42.4	0.0	42.4				0.0	8.0	15.4	44.3	2.7	0.0
Incr Delay (d2), s/veh	4.5	0.0	4.8				0.0	0.2	15.2	19.3	0.6	0.0
Initial Q Delay(d3),s/veh	0.0	0.0	0.0				0.0	0.0	0.0	0.0	0.0	0.0
%ile BackOfQ(50%),veh/ln	4.5	0.0	3.9				0.0	6.2	28.5	5.0	3.7	0.0
LnGrp Delay(d),s/veh	47.0	0.0	47.2				0.0	8.2	30.7	63.5	3.3	0.0
LnGrp LOS	D		D					A	C	E	A	
Approach Vol, veh/h		294						1463			776	
Approach Delay, s/veh		47.1						23.3			26.7	
Approach LOS		D						C			C	
Timer	1	2	3	4	5	6	7	8				
Assigned Phs		2			5	6		8				
Phs Duration (G+Y+Rc), s		84.1			14.3	69.8		16.1				
Change Period (Y+Rc), s		6.0			3.7	6.0		4.9				
Max Green Setting (Gmax), s		78.1			10.6	63.8		21.0				
Max Q Clear Time (g_c+1), s		9.0			10.7	57.3		10.5				
Green Ext Time (p_c), s		1.8			0.0	3.9		0.8				
Intersection Summary												
HCM 2010 Ctrl Delay			27.1									
HCM 2010 LOS			C									

Intersection

Intersection Delay, s/veh 8.3
 Intersection LOS A

Approach	EB	WB	NB	SB
Entry Lanes	0	1	1	2
Conflicting Circle Lanes	2	2	2	2
Adj Approach Flow, veh/h	0	668	600	553
Demand Flow Rate, veh/h	0	693	609	564
Vehicles Circulating, veh/h	761	609	0	502
Vehicles Exiting, veh/h	187	0	761	422
Follow-Up Headway, s	3.186	3.186	3.186	3.186
Ped Vol Crossing Leg, #/h	0	0	0	0
Ped Cap Adj	1.000	1.000	1.000	1.000
Approach Delay, s/veh	0.0	4.9	9.6	10.9
Approach LOS	-	A	A	B

Lane	Left	Bypass	Left	Left	Bypass
Designated Moves	LT	R	LT	T	R
Assumed Moves	LT	R	LT	T	R
RT Channelized		Free			Free
Lane Util	1.000		1.000	1.000	
Critical Headway, s	4.113		4.113	4.293	
Entry Flow, veh/h	315	378	609	446	118
Cap Entry Lane, veh/h	738	1938	1130	775	1938
Entry HV Adj Factor	0.943	0.980	0.985	0.980	0.980
Flow Entry, veh/h	297	371	600	437	116
Cap Entry, veh/h	696	1900	1113	760	1900
V/C Ratio	0.427	0.195	0.539	0.575	0.061
Control Delay, s/veh	11.1	0.0	9.6	13.8	0.0
LOS	B	A	A	B	A
95th %tile Queue, veh	2	1	3	4	0



















HCM 2010 Roundabout
 2: River Rd. & Hwy 68 EB Ramps

Cumulative + Project AM-Miti_2.syn
 01/17/2022

Intersection									
Intersection Delay, s/veh	6.6								
Intersection LOS	A								
Approach	EB		WB		NB		SB		
Entry Lanes	1		0		1		2		
Conflicting Circle Lanes	1		1		1		1		
Adj Approach Flow, veh/h	294		0		1463		776		
Demand Flow Rate, veh/h	298		0		1483		799		
Vehicles Circulating, veh/h	799		647		470		0		
Vehicles Exiting, veh/h	0		311		488		647		
Follow-Up Headway, s	3.186		3.186		3.186		3.186		
Ped Vol Crossing Leg, #/h	0		0		0		0		
Ped Cap Adj	1.000		1.000		1.000		1.000		
Approach Delay, s/veh	6.4		0.0		6.4		7.1		
Approach LOS	A		-		A		A		
Lane	Left		Bypass		Left		Bypass	Left	Right
Designated Moves	LT		R		T		R	L	TR
Assumed Moves	LT		R		T		R	L	TR
RT Channelized			Free				Free		
Lane Util	1.000				1.000			0.389	0.611
Critical Headway, s	5.193				5.193			5.193	5.193
Entry Flow, veh/h	159		139		488		995	311	488
Cap Entry Lane, veh/h	508		1957		706		1919	1130	1130
Entry HV Adj Factor	1.000		0.971		0.980		0.990	0.971	0.971
Flow Entry, veh/h	159		135		478		985	302	474
Cap Entry, veh/h	508		1900		692		1900	1097	1097
V/C Ratio	0.313		0.071		0.691		0.518	0.275	0.432
Control Delay, s/veh	11.8		0.0		19.4		0.0	5.9	7.9
LOS	B		A		C		A	A	A
95th %tile Queue, veh	1		0		6		3	1	2



















HCM 2010 Signalized Intersection Summary
 1: Hwy 68 WB Ramps & Reservation Rd.

Cumulative + Project PM-Miti_1.syn
 01/17/2022

												
Movement	EBL	EBT	EBR	WBL	WBT	WBR	NBL	NBT	NBR	SBL	SBT	SBR
Lane Configurations												
Traffic Volume (veh/h)	0	0	0	519	0	275	125	251	0	0	609	154
Future Volume (veh/h)	0	0	0	519	0	275	125	251	0	0	609	154
Number				7	4	14	1	6	16	5	2	12
Initial Q (Qb), veh				0	0	0	0	0	0	0	0	0
Ped-Bike Adj(A_pbT)				1.00		1.00	1.00		1.00	1.00		1.00
Parking Bus, Adj				1.00	1.00	1.00	1.00	1.00	1.00	1.00	1.00	1.00
Adj Sat Flow, veh/h/ln				1900	1900	1900	1863	1810	0	0	1881	1881
Adj Flow Rate, veh/h				564	0	299	136	273	0	0	662	167
Adj No. of Lanes				0	1	1	1	1	0	0	1	1
Peak Hour Factor				0.92	0.92	0.92	0.92	0.92	0.92	0.92	0.92	0.92
Percent Heavy Veh, %				0	0	0	2	5	0	0	1	1
Cap, veh/h				627	0	560	163	989	0	0	755	599
Arrive On Green				0.35	0.00	0.35	0.09	0.55	0.00	0.00	0.40	0.37
Sat Flow, veh/h				1810	0	1615	1774	1810	0	0	1881	1599
Grp Volume(v), veh/h				564	0	299	136	273	0	0	662	167
Grp Sat Flow(s),veh/h/ln				1810	0	1615	1774	1810	0	0	1881	1599
Q Serve(g_s), s				22.2	0.0	11.1	5.7	6.0	0.0	0.0	24.4	5.5
Cycle Q Clear(g_c), s				22.2	0.0	11.1	5.7	6.0	0.0	0.0	24.4	5.5
Prop In Lane				1.00		1.00	1.00		0.00	0.00		1.00
Lane Grp Cap(c), veh/h				627	0	560	163	989	0	0	755	599
V/C Ratio(X)				0.90	0.00	0.53	0.83	0.28	0.00	0.00	0.88	0.28
Avail Cap(c_a), veh/h				627	0	560	166	989	0	0	755	599
HCM Platoon Ratio				1.00	1.00	1.00	1.00	1.00	1.00	1.00	1.00	1.00
Upstream Filter(I)				1.00	0.00	1.00	1.00	1.00	0.00	0.00	1.00	1.00
Uniform Delay (d), s/veh				23.3	0.0	19.6	33.5	9.1	0.0	0.0	20.7	16.4
Incr Delay (d2), s/veh				18.2	0.0	3.6	28.6	0.7	0.0	0.0	11.4	0.3
Initial Q Delay(d3),s/veh				0.0	0.0	0.0	0.0	0.0	0.0	0.0	0.0	0.0
%ile BackOfQ(50%),veh/ln				14.1	0.0	5.5	4.1	3.1	0.0	0.0	14.9	2.5
LnGrp Delay(d),s/veh				41.5	0.0	23.3	62.1	9.8	0.0	0.0	32.1	16.6
LnGrp LOS				D		C	E	A			C	B
Approach Vol, veh/h					863			409			829	
Approach Delay, s/veh					35.2			27.2			29.0	
Approach LOS					D			C			C	
Timer	1	2	3	4	5	6	7	8				
Assigned Phs	1	2		4		6						
Phs Duration (G+Y+Rc), s	10.9	34.1		30.0		45.0						
Change Period (Y+Rc), s	3.7	6.0		4.9		6.0						
Max Green Setting (Gmax), s	7.3	28.0		25.1		39.0						
Max Q Clear Time (g_c+I1), s	7.7	26.4		24.2		8.0						
Green Ext Time (p_c), s	0.0	0.6		0.4		0.9						
Intersection Summary												
HCM 2010 Ctrl Delay				31.2								
HCM 2010 LOS				C								

HCM 2010 Signalized Intersection Summary
 2: River Rd. & Hwy 68 EB Ramps

Cumulative + Project PM-Miti_1.syn
 01/17/2022

												
Movement	EBL	EBT	EBR	WBL	WBT	WBR	NBL	NBT	NBR	SBL	SBT	SBR
Lane Configurations												
Traffic Volume (veh/h)	79	0	236	0	0	0	0	297	379	290	837	0
Future Volume (veh/h)	79	0	236	0	0	0	0	297	379	290	837	0
Number	3	8	18				1	6	16	5	2	12
Initial Q (Qb), veh	0	0	0				0	0	0	0	0	0
Ped-Bike Adj(A_pbT)	1.00		1.00				1.00		1.00	1.00		1.00
Parking Bus, Adj	1.00	1.00	1.00				1.00	1.00	1.00	1.00	1.00	1.00
Adj Sat Flow, veh/h/ln	1900	1900	1900				0	1881	1881	1863	1900	0
Adj Flow Rate, veh/h	84	0	251				0	316	403	309	890	0
Adj No. of Lanes	0	1	1				0	1	1	2	1	0
Peak Hour Factor	0.94	0.94	0.94				0.94	0.94	0.94	0.94	0.94	0.94
Percent Heavy Veh, %	0	0	0				0	1	1	2	0	0
Cap, veh/h	400	0	357				0	777	660	416	1170	0
Arrive On Green	0.22	0.00	0.22				0.00	0.41	0.41	0.12	0.62	0.00
Sat Flow, veh/h	1810	0	1615				0	1881	1599	3442	1900	0
Grp Volume(v), veh/h	84	0	251				0	316	403	309	890	0
Grp Sat Flow(s),veh/h/ln	1810	0	1615				0	1881	1599	1721	1900	0
Q Serve(g_s), s	1.9	0.0	7.0				0.0	5.8	9.7	4.2	16.6	0.0
Cycle Q Clear(g_c), s	1.9	0.0	7.0				0.0	5.8	9.7	4.2	16.6	0.0
Prop In Lane	1.00		1.00				0.00		1.00	1.00		0.00
Lane Grp Cap(c), veh/h	400	0	357				0	777	660	416	1170	0
V/C Ratio(X)	0.21	0.00	0.70				0.00	0.41	0.61	0.74	0.76	0.00
Avail Cap(c_a), veh/h	810	0	723				0	777	660	450	1170	0
HCM Platoon Ratio	1.00	1.00	1.00				1.00	1.00	1.00	1.00	1.00	1.00
Upstream Filter(I)	1.00	0.00	1.00				0.00	1.00	1.00	1.00	1.00	0.00
Uniform Delay (d), s/veh	15.6	0.0	17.6				0.0	10.1	11.3	20.8	6.8	0.0
Incr Delay (d2), s/veh	0.3	0.0	2.5				0.0	0.3	1.6	6.0	4.7	0.0
Initial Q Delay(d3),s/veh	0.0	0.0	0.0				0.0	0.0	0.0	0.0	0.0	0.0
%ile BackOfQ(50%),veh/ln	0.9	0.0	3.3				0.0	3.1	4.6	2.4	9.9	0.0
LnGrp Delay(d),s/veh	15.8	0.0	20.1				0.0	10.5	12.9	26.8	11.5	0.0
LnGrp LOS	B		C					B	B	C	B	
Approach Vol, veh/h		335						719			1199	
Approach Delay, s/veh		19.0						11.8			15.4	
Approach LOS		B						B			B	
Timer	1	2	3	4	5	6	7	8				
Assigned Phs		2			5	6		8				
Phs Duration (G+Y+Rc), s		34.1			9.9	24.2		14.8				
Change Period (Y+Rc), s		6.0			3.7	6.0		4.9				
Max Green Setting (Gmax), s		28.1			6.7	17.7		21.0				
Max Q Clear Time (g_c+I1), s		18.6			6.2	11.7		9.0				
Green Ext Time (p_c), s		2.9			0.1	1.6		1.0				
Intersection Summary												
HCM 2010 Ctrl Delay			14.8									
HCM 2010 LOS			B									

Intersection					
Intersection Delay, s/veh	24.8				
Intersection LOS	C				
Approach	EB	WB	NB	SB	
Entry Lanes	0	1	1	2	
Conflicting Circle Lanes	2	2	2	2	
Adj Approach Flow, veh/h	0	863	409	829	
Demand Flow Rate, veh/h	0	863	426	838	
Vehicles Circulating, veh/h	1233	426	0	703	
Vehicles Exiting, veh/h	139	0	1233	287	
Follow-Up Headway, s	3.186	3.186	3.186	3.186	
Ped Vol Crossing Leg, #/h	0	0	0	0	
Ped Cap Adj	1.000	1.000	1.000	1.000	
Approach Delay, s/veh	0.0	10.5	7.2	48.5	
Approach LOS	-	B	A	E	
Lane	Left	Bypass	Left	Left	Bypass
Designated Moves	LT	R	LT	T	R
Assumed Moves	LT	R	LT	T	R
RT Channelized		Free			Free
Lane Util	1.000		1.000	1.000	
Critical Headway, s	4.113		4.113	4.293	
Entry Flow, veh/h	564	299	426	669	169
Cap Entry Lane, veh/h	839	1900	1130	667	1919
Entry HV Adj Factor	1.000	1.000	0.961	0.990	0.990
Flow Entry, veh/h	564	299	409	662	167
Cap Entry, veh/h	839	1900	1086	660	1900
V/C Ratio	0.673	0.157	0.377	1.003	0.088
Control Delay, s/veh	16.0	0.0	7.2	60.8	0.0
LOS	C	A	A	F	A
95th %tile Queue, veh	5	1	2	16	0

HCM 2010 Roundabout
 2: River Rd. & Hwy 68 EB Ramps

Cumulative + Project PM-Miti_2.syn
 01/17/2022

Intersection

Intersection Delay, s/veh 4.8
 Intersection LOS A

Approach	EB	WB	NB	SB
Entry Lanes	1	0	1	2
Conflicting Circle Lanes	1	1	1	1
Adj Approach Flow, veh/h	335	0	719	712
Demand Flow Rate, veh/h	335	0	726	718
Vehicles Circulating, veh/h	718	403	399	0
Vehicles Exiting, veh/h	0	315	403	403
Follow-Up Headway, s	3.186	3.186	3.186	3.186
Ped Vol Crossing Leg, #/h	0	0	0	0
Ped Cap Adj	1.000	1.000	1.000	1.000
Approach Delay, s/veh	2.1	0.0	4.5	6.4
Approach LOS	A	-	A	A

Lane	Left	Bypass	Left	Bypass	Left	Right
Designated Moves	LT	R	T	R	L	TR
Assumed Moves	LT	R	T	R	L	TR
RT Channelized		Free		Free		
Lane Util	1.000		1.000		0.439	0.561
Critical Headway, s	5.193		5.193		5.193	5.193
Entry Flow, veh/h	84	251	319	407	315	403
Cap Entry Lane, veh/h	551	1900	758	1919	1130	1130
Entry HV Adj Factor	1.000	1.000	0.990	0.990	0.981	1.000
Flow Entry, veh/h	84	251	316	403	309	403
Cap Entry, veh/h	551	1900	751	1900	1108	1130
V/C Ratio	0.152	0.132	0.421	0.212	0.279	0.357
Control Delay, s/veh	8.5	0.0	10.3	0.0	5.9	6.7
LOS	A	A	B	A	A	A
95th %tile Queue, veh	1	0	2	1	1	2

Appendix D
Las Palmas Road Entrance Gate
Queuing Analysis

M/M/s/K Queue

Inputs:

Arrival rate (λ)	41
Service rate per server (μ)	600
Number of servers (s)	1
System capacity (K)	6

Steady-state Distribution

n	P_n
0	0.931667
1	0.063664
2	0.004350
3	0.000297
4	0.000020
5	0.000001
6	0.000000

Steady-State Operating Characteristics

Probability that the system is empty	P_0	0.931667
Probability that the system is full	P_K	0.000000
Average rate that customers enter	$\lambda*(1-P_K)$	40.999996
Average number of customers in line	L_q	0.005012
Average time spent in line	W_q	0.000122
Average time spent in the system	W	0.001789
Average number of customers in system	L	0.073345
Maximum Utilization	$\lambda/(s\mu)$	0.068333
Effective Utilization (traffic intensity)	ρ	0.068333327

M/M/s/K Queue

Inputs:

Arrival rate (λ)	106
Service rate per server (μ)	600
Number of servers (s)	1
System capacity (K)	6

Steady-state Distribution

n	P_n
0	0.823338
1	0.145456
2	0.025697
3	0.004540
4	0.000802
5	0.000142
6	0.000025

Steady-State Operating Characteristics

Probability that the system is empty	P_0	0.823338
Probability that the system is full	P_K	0.000025
Average rate that customers enter	$\lambda^*(1-P_K)$	105.997347
Average number of customers in line	L_q	0.037875
Average time spent in line	W_q	0.000357
Average time spent in the system	W	0.002024
Average number of customers in system	L	0.214537
Maximum Utilization	$\lambda/(s\mu)$	0.176667
Effective Utilization (traffic intensity)	ρ	0.176662244

M/M/s/K Queue

Inputs:

Arrival rate (λ)	48
Service rate per server (μ)	600
Number of servers (s)	1
System capacity (K)	6

Steady-state Distribution

n	P_n
0	0.920000
1	0.073600
2	0.005888
3	0.000471
4	0.000038
5	0.000003
6	0.000000

Steady-State Operating Characteristics

Probability that the system is empty	p_0	0.920000
Probability that the system is full	p_K	0.000000
Average rate that customers enter	$\lambda^*(1-p_K)$	47.999988
Average number of customers in line	L_q	0.006956
Average time spent in line	W_q	0.000145
Average time spent in the system	W	0.001812
Average number of customers in system	L	0.086956
Maximum Utilization	$\lambda/(s\mu)$	0.080000
Effective Utilization (traffic intensity)	ρ	0.07999981

M/M/s/K Queue

Inputs:

Arrival rate (λ)	122
Service rate per server (μ)	600
Number of servers (s)	1
System capacity (K)	6

Steady-state Distribution

n	P_n
0	0.796678
1	0.161991
2	0.032938
3	0.006697
4	0.001362
5	0.000277
6	0.000056

Steady-State Operating Characteristics

Probability that the system is empty	P_0	0.796678
Probability that the system is full	P_K	0.000056
Average rate that customers enter	$\lambda^*(1-P_K)$	121.993131
Average number of customers in line	L_q	0.051808
Average time spent in line	W_q	0.000425
Average time spent in the system	W	0.002091
Average number of customers in system	L	0.255130
Maximum Utilization	$\lambda/(s\mu)$	0.203333
Effective Utilization (traffic intensity)	ρ	0.203321885

M/M/s/K Queue

Inputs:

Arrival rate (λ)	54
Service rate per server (μ)	600
Number of servers (s)	1
System capacity (K)	6

Steady-state Distribution

n	P_n
0	0.910000
1	0.081900
2	0.007371
3	0.000663
4	0.000060
5	0.000005
6	0.000000

Steady-State Operating Characteristics

Probability that the system is empty	p_0	0.910000
Probability that the system is full	p_K	0.000000
Average rate that customers enter	$\lambda \cdot (1 - p_K)$	53.999974
Average number of customers in line	L_q	0.008901
Average time spent in line	W_q	0.000165
Average time spent in the system	W	0.001831
Average number of customers in system	L	0.098901
Maximum Utilization	$\lambda / (s\mu)$	0.090000
Effective Utilization (traffic intensity)	ρ	0.089999956

M/M/s/K Queue

Inputs:

Arrival rate (λ)	138
Service rate per server (μ)	600
Number of servers (s)	1
System capacity (K)	6

Steady-state Distribution

n	p_n
0	0.770026
1	0.177106
2	0.040734
3	0.009369
4	0.002155
5	0.000496
6	0.000114

Steady-State Operating Characteristics

Probability that the system is empty	p_0	0.770026
Probability that the system is full	p_K	0.000114
Average rate that customers enter	$\lambda^*(1-p_K)$	137.984269
Average number of customers in line	L_q	0.068489
Average time spent in line	W_q	0.000496
Average time spent in the system	W	0.002163
Average number of customers in system	L	0.298463
Maximum Utilization	$\lambda/(s\mu)$	0.230000
Effective Utilization (traffic intensity)	ρ	0.229973782

Keith Higgins

Traffic Engineer

March 4, 2022

Dale Ellis
Anthony Lombardo & Associates
144 W. Gabilan Street
Salinas, CA 93901

Re: Riverview Estates Subdivision - Traffic Effects from Expansion from 28 to 30 Lots, Monterey County, CA

Dear Dale,

Per your recent request, this letter describes the effects of the modification of the Riverview Estates Subdivision from 28 to 30 lots, Monterey County, CA. It is based on the "Riverview at Las Palmas Residential Subdivision Transportation Impact Analysis," Keith Higgins Traffic Engineer, January 19, 2022 (Project Traffic Study).

A. Project Trip Generation

As indicated on **Attachment A**, the current 30-lot proposal is about 7% larger than the previous 28-lot proposal. The current 30-lot proposal will generate about 283 daily trips with 21 during the AM peak hour and 28 during the PM peak hour. This compares with the previous 28 lot proposal which would generate about 264 daily trips with 20 AM peak hour trips and 26 PM peak hour trips. The current proposal would result in an increase of about 19 daily trips with one additional AM peak hour trip and two additional PM peak hour trips.

B. Intersection Levels of Service

Attachment B provides a comparison of levels of service at the Reservation Road / Highway 68 WB Ramps, River Road / Highway 68 EB Ramps and Las Palmas Road / River Road intersections between the previous 28-lot project proposal with the current 30-lot proposal for Existing plus Project and Cumulative plus Project conditions. Existing levels of service are also included. The original 28 lot proposal was expected to result in imperceptible increases in delay and no change in level of service from existing conditions. The increase of two lots above the previous proposal associated with current 30-lot project will result in virtually no change in delay and level of service compared to the previous proposal under both Existing plus Project and Cumulative plus Project conditions. The conclusions and recommendations in the Project Traffic Study are unchanged regarding intersection traffic operations.

C. Road Segment Levels of Service

The previous 28-lot proposal was expected to result in an increase about 3 AM peak hour trips and 4 PM peak hour trips to the two-lane segment of Hwy 68 immediately west of the Toro Park interchange. Only about 14% of the anticipated increase in Project trip generation of one AM peak hour trip and two PM peak hour trips will be added to the two-lane segment of Highway 68. This is less than one peak hour trip on average, which is an immeasurable increase and will not result in any change in the conclusions and recommendations in the Project Traffic Study.

Dale Ellis
March 4, 2022

D. Las Palmas 1 Neighborhood Streets

The current proposal will result in an increase of 19 daily trips along the access route through Las Palmas 1 from River Road to the Project site. This includes Las Palmas Road, River Run Road, and Woodbridge Court.

Las Palmas Road will carry about 2,506 daily trips compared to the estimate of 2,487 vehicles per day in the project traffic study which is an imperceptible increase of less than 1%. The resulting traffic volume will continue to be well below the 3,000 vehicle-per-day threshold for a Monterey County Secondary Street or the typical carrying capacity of 10,000 vehicles per day for a two lane collector street.

River Run Road will carry about 1,233 vehicles per day, compared to 1,214 resulting from the previous 28-lot proposal. This is an increase of about 1.6% which is imperceptible. River Run Road will carry daily traffic volumes about 40% below the Level of Service C threshold for a modified secondary/tertiary street.

Woodbridge Court conforms to the standards of a Monterey County Loop Street. This street can provide access to 30 homes or less, which is the number of homes included in the current Project proposal.

The Las Palmas Road / River Road and River Road / Woodbridge Court intersections within Las Palmas 1 both operate at Level of Service A. The addition of 1 to 2 peak hour trips from the two additional homes will be imperceptible. Both intersections will continue to operate at LOS A.

The proposed addition of two lots will not change its effects on traffic operations within Las Palmas 1.

E. Las Palmas 1 Entrance Traffic Operations

The addition of two homes to the Project will result in an increase of about one inbound trip at the Las Palmas 1 Entrance on Las Palmas Road compared to the increase previously anticipated from the Project. This would increase the total PM peak hour total entering volume in the Cumulative plus Project scenario from 138 vehicles to 139 vehicles, or about 0.7%. This compares with a service capacity of about 600 vehicles per hour. This would not change the anticipated queue lengths and would thus have an imperceptible effect on Las Palmas Road at the entrance to Las Palmas 1.

F. Summary and Conclusion

The addition of two homesites to the proposed Riverview Estates Subdivision will not qualitatively change Project traffic impacts. No changes are required to the analysis and recommendations in the "Riverview at Las Palmas Residential Subdivision Transportation Impact Analysis."

If you have any questions regarding this evaluation, please do not hesitate to contact me at your convenience.

Thank you for the opportunity to assist you with this project.

Respectfully submitted,

Keith Higgins

Keith B. Higgins, PE, TE

Enclosures

Previous and Current Single Family Residential Subdivision Trip Generation

TRIP GENERATION RATES ¹	ITE Land Use Code	Daily Trip Rate	AM Peak Hour				PM Peak Hour			
			Peak Hour Rate	% of ADT	% In	% Out	Peak Hour Rate	% of ADT	% In	% Out
Single-Family Detached Housing	210	0.43	0.7	7%	26%	74%	0.94	10%	63%	37%
GENERATED TRIPS	Project Size	Daily Trips	Peak Hour Trips	% of ADT	Trips Inbound	Trips Outbound	Peak Hour Trips	% of ADT	Trips Inbound	Trips Outbound
CURRENT 30-LOT PROPOSAL	30 Homes	283	21	7%	5	16	28	10%	18	10
PREVIOUS 28-LOT PROPOSAL	28 Homes	264	20	8%	5	15	26	10%	16	10
CURRENT PROPOSAL INCREASE ABOVE PREVIOUS PROPOSAL	2 Homes	19	1		0	1	2		1	1
CURRENT PROPOSAL PERCENT INCREASE ABOVE PREVIOUS PROPOSAL	7%									

Notes:

1. Trip generation rates published by Institute of Transportation Engineers, Trip Generation, 11th Edition, 2021.

**Attachment A
Current and Previous
Project Trip Generation
Comparison**

N-S Street	E-W Street	Existing Lane Configuration	Existing Intersection Control	LOS Standard	Existing Conditions		Existing + Project Conditions						Cumulative + Project Conditions												
					AM Peak Hr.		PM Peak Hr.		Previous Project - 28 Lots		Current Project - 30 Lots		Previous Project - 28 Lots		Current Project - 30 Lots										
					Delay (sec)	LOS	Delay (sec)	LOS	Delay (sec)	LOS	Delay (sec)	LOS	Delay (sec)	LOS	Delay (sec)	LOS	Delay (sec)	LOS							
1	Reservation Road	Highway 68 WB Ramps	NB 1-L, 1-T SB 1-T/R WB 1-L/T, 1-R	Signal	Caltrans C	20.3	C	31.3	C	20.3	C	32.0	C	20.3	C	32.1	C	24.6	C	48.7	D	24.6	C	48.8	D
						20.8	C	31.1	C	20.8	C	31.1	C	20.8	C	31.1	C	20.8	C	31.1	C	20.8	C	31.1	C
2	River Road	Highway 68 EB Ramps	NB 1-T, 1-R SB 1-L, 1-T EB 1-L/T, 1-R	Signal	Caltrans C	26.3	C	14.5	B	26.5	C	14.6	B	26.5	C	14.6	B	42.7	D	17.8	B	42.7	D	17.8	B
						27.0	C	14.8	B	27.0	C	14.8	B	27.0	C	14.8	B	27.0	C	14.8	B	27.0	C	14.8	B
3	Las Palmas Road	River Road	NB 1-L, 1-R EB 2-T, 1-R WB 1-L, 2-T	Signal	County D	4.9	A	4.2	A	5.0	A	4.4	A	5.0	A	4.4	A	5.3	A	4.4	A	5.3	A	4.4	A

Notes:

- 1 L, T, R = Left, Through, Right
- 2 NB, SB, EB, WB = Northbound, Southbound, Eastbound, Westbound
- 3 Highlighted levels of service exceed jurisdiction's LOS standard.
- 4 Miti 1 = Add SBR at Intersection #1 and 2nd SBL at Intersection #2.
- 5 Miti 2 = Convert Intersections #1 and #2 to roundabouts.

**Attachment B
Current and
Previous Project
Intersection
Levels of Service
Comparison**

EXHIBIT C

LOW, MODERATE AND WORKFORCE 2 (3 BEDROOM/4 PERSONS)/5.0% MORTGAGE (with HOA, Sewer and Travel)

Limits per County Tables	VERY LOW	LOW (80%)	MODERATE (120%)	WORKFORCE 1	WORKFORCE 2
Income (Annual)	50,850	81,350	97,900	122,400	146,900
Income (Monthly)	4,238	6,779	8,158	10,200	12,242
Max Sale Price	174,313	278,865	391,533	489,516	587,499
Mortgage (10% down)	156,882	250,979	352,380	440,564	528,749
Monthly Allowance*	1,271	2,034	2,855	3,570	4,285
Monthly Utility Allowance**					
Heat	67	67	67	67	67
Range	18	18	18	18	18
Refrigerator	19	19	19	19	19
Water Heater	44	44	44	44	44
Water	129	129	129	129	129
Sewer (Actual Cost)	140	140	140	140	140
Other	81	81	81	81	81
Trash	24	24	24	24	24
Total	522	522	522	522	522
Other Monthly Costs					
HOA	162	162	162	162	162
Home Owner Insurance	60	60	60	60	60
Property Tax***	74	119	166	208	250
Phone/TV/Internet	150	150	150	150	150
Mortgage Insurance****	131	209	294	367	441
Transportation	450	450	450	450	450
Total	1,027	1,150	1,282	1,397	1,512
Total Monthly Costs					
	1,549	1,672	1,804	1,919	2,034
Monthly Allowance	1,271	2,034	2,855	3,570	4,285
Dollars Available for Mortgage	-278	362	1,051	1,651	2,251
Max Mortgage @ 5.0%*****					
	0	67,600	196,073	307,989	419,905
Max Sales Price*****					
	0	74,360	215,680	338,787	461,895
Difference in Max Price					
	-174,313	-204,505	-175,853	-150,729	-125,604
* 30% Low; 35% Moderate and Workforce					
** Housing Choice Voucher (Electric)					
*** 0.51% value					
**** 1% of mortgage /yr					
***** \$5.36/1,000					

EXHIBIT E

Exhibit G - Appendix B

This page intentionally left blank.

RIVER VIEW at LAS PALMAS

TWENTY-SIX LOT ALTERNATIVE PROJECT

River View at Las Palmas proposed, as an alternative to the Residential Care Facility for the Elderly (RV-1), a 30-lot single-family residential subdivision (RV-2). The design of the VTM was submitted in November 2022. Following further discussions with the Housing and Community Development Department on the affordable housing component and the difficulty of on-site affordable housing for both ultimate residents and applicant, it was determined a 26-lot proposal which did not include on-site affordable units and provided instead for an in-lieu fee of approximately \$780,000 to be paid might be favorably considered. The benefit of paying the fee in this case would be the realization of a greater impact by creating substantially more affordable units off-site than the four units on the River View site. The attached Vesting Tentative Map illustrates the proposed layout of the 26-unit alternative subdivision, (RV-3), and follows the basic design of the 30-lot subdivision. The 26-lot project will:

- Have a proportionately lesser impact (approximately ***15%***) on water, waste water, traffic, GHG, air quality and similar impacts.
- The lots at the western end of the subdivision, which is the most visible and steepest portion of the property have been eliminated, reducing the project's visibility even further and reducing grading for both the road and the lots which were deleted.
- Less grading and construction disruption may result in reducing housing delivery times.
- The lots have been adjusted so that the 26 homes will be built on lesser grades, further reducing grading.

It is not the intention of this analysis to reiterate the discussion in the RV-2 analysis, which is incorporated by reference. Where there may be a notable difference, that difference will be identified and discussed.

CEQA

Housing and Community Development (HCD) staff have determined additional information is needed to bolster the assessment of not only this alternative but the alternatives already analyzed in the FSEIR. This additional information is not expected to be significant new information as defined by CEQA Guidelines Section 15088.5 and thus will not necessitate recirculation of the additional information. No impacts not already identified and analyzed in the FSEIR will be created. No new or additional mitigations have been found to be required for the 26-lot alternative.

Housing and Community Development previously found that recirculation of the 30-lot alternative is not required.

IMPACTS OF THE 26-LOT ALTERNATIVE

The 26-lot alternative will, as previously noted, have a proportionately lesser impacts in comparison to the impacts of RV-1 which were discussed in the FEIR, (*shown in italics*) and the

previously discussed 30-lot alternative. In each case, the source of the listed impact is the RV-1 FSEIR.

AESTHETICS

IMPACT: The Proposed Project [RV-1] Would have an Adverse Impact on Scenic Vistas and the Existing Viewshed when Viewed from State Route 68, River Road, and Reservation Road and Alter the Existing Visual Character of the Project Site (Less than Significant with Mitigation)

The alternative project will have a substantially reduced visual impact from either RV-1 or the 40-lot alternative:

- The alternative proposes 26 single-family homes. All of the homes will be single story. The applicants are voluntarily proposing to restrict the homes to 20' in height¹ rather than the 30' allowed by the MDR district regulations. In contrast, the RV-1 project proposed two multistory buildings (RV-1) each nearing 30' in height.
- The four lots which were eliminated were in the steepest, most visible portion of the property.
- The 26-lot alternative will implement the mitigations included in the FSEIR for landscaping, colors and materials, underground utilities and exterior lighting.

AIR QUALITY

IMPACT: Construction Emissions that Contribute to the Air Basin's Non-Attainment status (Less than Significant with Mitigation)

IMPACT: Exposure of Sensitive Receptors to Construction Dust and Diesel Exhaust Emissions (Less than Significant with Mitigation)

IMPACT: Exposures to New Sources of Toxic Air Contaminants (Less than Significant Impact with Mitigation)

BIOLOGY

IMPACT: Potential Loss or Disturbance of American Badger (Less than Significant with Mitigation)

IMPACT: Potential Loss or Disturbance of Burrowing Owl (Less than Significant with Mitigation)

IMPACT: Potential Loss or Disturbance of Monterey Dusky-Footed Woodrat (Less than Significant with Mitigation)

¹ "Height of structure" means the vertical distance from the average level of the highest and lowest point of the natural grade of that portion of the building site covered by the structure, to the topmost point of the structure, but excluding certain features as specified in Chapter 21.62 (Height and Setback Exceptions) of this Title. (Section 21.06.630. Monterey County Code). The MDR district height limit is 30 feet.

IMPACT: Potential Loss or Disturbance of Special-Status Western Red Bat (Less than Significant with Mitigation)

IMPACT: Potential Loss or Disturbance of Protected Nesting Birds (Less than Significant with Mitigation)

IMPACT: Impede Movement of Common Wildlife (Less than Significant)

The 26-lot alternative will have a proportionately reduced impact from the RV-1 project and the RV-2 alternative and will implement the mitigations included in the FSEIR for biology.

GREEN HOUSE GAS

IMPACT: Generation of 634.02 Metric Tons (MT) of Carbon Dioxide Equivalent (CO₂e) per Year (Less than Significant)

The 26-lot alternative will have a proportionately reduced impact from the RV-1 project and the RV-2 alternative and will implement the mitigations included in the FSEIR for GHG.

.

TRANSPORTATION

IMPACT: The Proposed Project Would Add Vehicle Trips to Local Neighborhood Roadways and Intersections (Less than Significant)

IMPACT: The Proposed Project Would Add Vehicle Trips to the Reservation Road and State Route 68 Westbound Ramp Intersection, River Road and State Route 68 Eastbound Ramp Intersection, and the River Road and Las Palmas Road Intersection (Less than Significant)

IMPACT: The Proposed Project Would Add Vehicle Trips to the River Road segments from State Route 68 to Las Palmas Road and Las Palmas Road to Las Palmas Parkway (Less than Significant)

IMPACT: The Proposed Project Would Add Vehicle Trips to State Route 68, which Currently Operates at Level of Service F (Significant and Unavoidable)

The 26-lot alternative will have a proportionately reduced impact from the RV-1 project and the RV-2 alternative and will implement the mitigations included in the FSEIR for transportation.

WATER SUPPLY

IMPACT: Increase Potable Water Demand for the Service Area by Approximately 11.376 AFY (Less than Significant)

California Water Service, the water purveyor for the specific plan area, has provided a “can and will serve” for the proposed project. Although California Water Service was not able to provide a current figure for actual water use in the specific plan area, California American Water Company, the wastewater treatment provider for the specific plan area, records wastewater flows from a period of January 2016 to February 2017 as an average of 162,398 gpd (email

communication with Mike Magretto, California American Water Company, March 13, 2017). This amount of wastewater flow, 162,398 gpd, equals approximately 182 AFY, less than half of the 599 AFY projected as water supply required and approved for the specific plan area. Common landscaped areas of the specific plan area utilize recycled water, but private residences use potable water for outdoor landscaping. However, water used for outdoor use is considered as a component of total water demand for a residence and therefore would not be considered additional water demand not already accounted for in totals. Therefore, it can be concluded that the proposed project and the entire Las Palmas Ranch development combined would use significantly less groundwater than projected in the original EIR.

As presented earlier in the groundwater setting of this section, the average annual groundwater extraction for the four noted subareas that compose Zone 2C was about 523,000 AFY from 1959 to 2013. The proposed project would add 11.376-acre feet per year, which is a 0.002 percent increase. This contribution to the cumulative existing impact is not considerable, and therefore, is a less-than-significant impact.

The 26-lot alternative will have a proportionately reduced impact from the RV-1 project and the RV-2 alternative and will implement the mitigations included in the FSEIR for water.

ENERGY

The County of Monterey has policies and regulations in place that require new development considers [sic] energy reduction and comply with standards that achieve a greater level of efficiency than current California Building Code Standards. Conformance to applicable energy conservation/efficiency regulations and standards would ensure that the proposed project would not result directly or indirectly result in inefficient, wasteful, and unnecessary consumption of energy.

ENG-1 Prior to approval of building permits for each of the project components, the applicant shall submit a report to the Director of Planning demonstrating how the project is consistent with the energy conservation policies identified in the Las Palmas Ranch Specific Plan.

The 26-lot alternative will have a proportionately reduced impact from the RV-1 project and the RV-2 alternative and will implement the mitigations included in the FSEIR for energy.

CUMULATIVE IMPACT

IMPACT: At a Cumulative Level, the Proposed Project Would Add Vehicle Trips to the Reservation Road and State Route 68 Westbound Ramp Intersection and the River Road and State Route 68 Eastbound Ramp Intersection (Less than Significant with Mitigation).

CTRA-1 The applicant shall pay Transportation Agency for Monterey County and County of Monterey traffic impact fees.

IMPACT: At a Cumulative Level, the Proposed Project Would Add Vehicle Trips to State Route 68 (Significant and Unavoidable).

The 26-lot alternative will have a proportionately reduced impact from the RV-1 project and the RV-2 alternative

POPULATION GROWTH

The Las Palmas Ranch Specific Plan was adopted by the Monterey County Board of Supervisors in 1983. Also in 1983, the Board of Supervisors adopted the Toro Area Plan, incorporating the Las Palmas Ranch Specific Plan by reference. The property was zoned “MDR/2.61-D” (Medium Density Residential, 2.61 units per acre, with Design Control). This zoning density would allow up to 40 dwellings for approval on the project site. In 2010, the Board of Supervisors adopted the Monterey County 2010 General Plan, including an updated Toro Area Plan, with the project site remaining identified for medium residential development at 2.61 units/acre.

The 26 lots will add, at four persons average per home, 104 persons to Las Palmas. This is well below the population that would be anticipated in the RV-1 project or the RV-2 alternative

UNAVOIDABLE IMPACTS

Traffic and Circulation IMPACT The Proposed Project Would Add Vehicle Trips to State Route 68, which Currently Operates at Level of Service F (Significant and Unavoidable)

IMPACT: At a Cumulative Level, the Proposed Project Would Add Vehicle Trips to State Route 68 (Significant and Unavoidable)

The 26-lot alternative will have a proportionately reduced impact from the RV-1 project and the RV-2 alternative and will implement the mitigations included in the FSEIR for transportation.

IRREVERSIBLE EFFECTS

16.2 PROPOSED PROJECT EFFECTS: The proposed project would include the consumption of non-renewable building materials and energy resources during the construction phase, as well as the ongoing consumption of energy for lighting, air conditioning, space and water heating, and travel to and from the site during the life of the project. The consumption of such resources is typical of this type of development and would result in an irreversible commitment of natural resources for construction and operations of the proposed project. The proposed project does not involve uses in which irreversible damage could result from any potential environmental accidents associated with the project.

The 26-lot alternative will have a proportionately reduced impact from the RV-1 project and the RV-2 alternative

EFFECTS NOT FOUND TO BE SIGNIFICANT

Chapter 11 of the FSEIR found no significant effect on Agriculture and Forest Resources, Cultural Resources, Geology and Soils, Hazardous Materials, Surface Hydrology, Mineral Resources, Noise, Public Services, Recreation, Solid Waste and Waste Water. The 30-lot subdivision will have an even lesser impact than the 40-unit alternative or the RV-1 would have had on all of those areas, except for schools.

RV-1, as a senior living facility, would not have generated a student population. Twenty-six new homes would result in approximately 39 students. The public schools serving Las Palmas are Spreckles Elementary School (K-5), Buena Vista Middle School (6-8) and Salinas High School (9-12). There are numerous private schools available in the area which also serve those grades.

The project will be required to pay school impact fees to the Salinas Union High School District and Spreckles School District to mitigate the impact of the added students.

LAS PALMAS RANCH UNIT 1 HOME OWNERS

We believe the LPR #1 homeowners have supported the 30-lot alternative. We are confident they will also support the 26-lot alternative.

AFFORDABLE HOUSING

There have been numerous discussions with HCD regarding alternative means to meet the project’s affordable housing obligation. Project costs have been heavily impacted by delays, substantial economic changes driven by rising interest rates, high rates of inflation, and increased cost of labor and materials. That, combined with the added costs of transportation, HOA fees, internet, sewer fees, taxes and upkeep does not allow for affordable units of any income level to be sold at or near the price allowed by the County’s affordability levels.

Affordability:

The narrative to the 30-lot alternative (RV-2) discusses the issues of affordability and the economic realities of providing affordable housing which would be feasible to provide and be sustainable for owners given the additional costs of living in the Las Palmas development. That discussion is incorporated by reference.

Limits per County Tables	VERY LOW	LOW (80%)	MODERATE (120%)	WORKFORCE 1	WORKFORCE 2
Income (Annual)	56,850	91,000	108,100	135,150	162,200
Income (Monthly)	4,738	7,583	9,008	11,263	13,517
Max Sale Price	194,881	311,945	432,326	540,508	648,688
Mortgage (10% down)	175,393	280,751	389,093	486,457	583,819
Monthly Allowance*	1,421	2,275	3,153	3,942	4,731
Total Monthly Costs	1,486	1,624	1,765	1,892	2,019

Monthly Allowance	1,421	2,275	3,153	3,942	4,731
Dollars Available for Mortgage	-65	651	1,388	2,050	2,712

Substantial added costs (HOA fees, sewer cost and added travel for basic services) specific to Las Palmas Ranch significantly and adversely affect the ability to provide affordable units in Las

Palmas Ranch. Collectively, those three factors add approximately \$700/per month² to the normal housing costs of utilities, insurance, maintenance, etc., at Las Palmas. Accordingly, the ability to build and provide affordable units, particularly at the lower income levels, on site is greatly reduced.

Other Monthly Costs					
HOA	162	162	162	162	162
Home Owner Insurance	100	100	100	100	100
Property Tax	83	133	184	230	276
Phone/TV/Internet	150	150	150	150	150
Mortgage Insurance	146	234	324	405	487
Transportation	450	450	450	450	450
Total	1,091	1,229	1,370	1,497	1,624

In-Lieu Fees:

The applicants have proposed four onsite units (moderate and workforce) as part of the 30-lot alternative. The 26-lot alternative is based on payment of in-lieu fees. Section 18.40.090 A.4 states: “The developer of a residential development containing five (5) or more units may elect to pay a fee in-lieu of providing some or all of the required inclusionary units if the developer demonstrates, in connection with the first approval for the residential development, that specific characteristics of the development site, such as lack of access to services, zoning which requires large lot development, or potentially high site maintenance costs, make the site unsuitable for households at the required income levels.”

Specific Site Characteristics include:

- Lack of services: The nearest location for food and gas is at a small commercial site with a mini-market and gas station 2.7 miles to the south. That site includes a restaurant and small offices but no other retail or professional services are closer than the City of Salinas, approximately 4 miles away.
- Neighborhood compatibility: The subdivision is designed to be in keeping with the basic style, design and home sizes of the adjoining Las Palmas Ranch Unit 1 development.
- Added transportation costs: There is no public transportation for Las Palmas or River Road in general. The 30-lot project would add 213 trips³ per day. A round trip to Salinas would be approximately 8 miles, Marina 18 miles

² A 5% mortgage costs approximately \$5.36/\$1,000. At that rate, the added \$700 reduces the mortgage by approximately \$130,600.

³ A trip is considered a round trip and includes all trips such as resident trips, postal and delivery services and other services such as landscapers, plumbers, etc.

and Monterey 30 miles. The following table is the estimated monthly cost⁴, per house, of the total combined trips using current IRS reimbursement rates.

Transportation Cost @ \$0.585/mile (IRS)	Trips* (213/day)	Miles (R/T)	Miles/day/SFD	Transportation Cost @ \$0.585/mile (IRS)/Day/SFD	Transportation Cost @ \$0.585/mile (IRS)/Month/SFD
Salinas (49%)	104	8	28	\$16	\$495
Marina (29%)	62	18	37	\$22	\$659
Monterey (17%)	36	30	36	\$21	\$644
<i>Total</i> ⁵				\$59	\$1,799

Assuming 50% of all trips (which is conservative) are resident generated and recognizing that there will be resident generated trips in any project, the projected added cost due to the location is estimated at 25% of the overall transportation cost per residence. That results in an approximate added cost, due solely to the project location, of \$450/month for transportation.

- Higher costs for sewer service: Current cost per unit for sewer service is approximately \$140/month.
- HOA fees: The HOA is responsible for road maintenance, landscaping, disposal of treated wastewater and drainage. The current monthly HOA cost is \$162/month.
- The site is 15.7 acres +/- . Due to slope and soil conditions only about half the property can be developed. The balance of the property will go into scenic easement and will require maintenance by property owners and the HOA.

LAS PALMAS RANCH SPECIFIC PLAN

Although we continue to disagree with the need to amend the LPRSP, we have agreed to continue with that process.

LAS PALMAS RANCH ZONING

No additional discussion is needed regarding the zoning history of the property.

DEVELOPMENT OF PARCEL Q AND RIDGELINE DEVELOPMENT

The HCD staff, its consultants and the Planning Commission have previously concluded Parcel Q is developable under the terms of the LPRSP and that the much larger RV-1 project would not have constituted ridgeline development.

⁴ This estimate is based on IRS reimbursement rates which do not reflect the recent significant increase in fuel costs.

⁵ The remaining 11 trips are southbound on River Road to undetermined destinations and are not included in this calculation.

CONCLUSION

The FSEIR prepared for the RV-1 project concluded RV-1's impact could readily be mitigated to an insignificant level with what would be considered to be routine mitigations. The FSEIR also evaluated alternatives to the RV-1, including a 40-unit residential project and concluded that 40-unit alternative would have an equivalent impact to the RV-1 project. As discussed in this narrative, the proposed 26 lot alternative would have a proportionally lesser impact than either the RV-1 project, the 40-unit alternative or RV-2.

The RV-3 26 lot project would not have on-site affordable housing. Instead, an in-lieu fee of approximately \$780,000 would be paid to support a greater number of affordable units in more viable locations.

The applicants have worked extensively with the LPR-1 residents to address their concerns and now have substantial support from those residents.

The information provided with the March 2, 2023 submittal is fully adequate to move this project forward for consideration. All issues including aesthetics, traffic, water, waste water, etc. have among the FSEIR, prior staff review and recommendations, Planning Commission recommendations, Board of Supervisors hearings, updated plans and this narrative, have been fully addressed.